

Operating instructions

LAUDA Low-temperature thermostats
RC 6 CS, RC 20 CS, RC 25 CS, RL 6 CS,
RL 7 CS, RK 8 CS, RK 8 KS, RK 20 KS

from serie A 01
01/02
YACE 0050

LAUDA DR. R. WOBSE
R GMBH & CO. KG
P.O. Box 1251
D- 97912 Lauda-Königshofen
Phone: +49/ (0)9343/ 503-0
Fax: +49/ (0)9343/ 503-222
E-mail info @ lauda.de
Internet <http://www.lauda.de>

1.	Brief operating instructions	5
2.	Technical Data to DIN 58966	7
3.	General construction and technical description	11
3.1	Operating principle	11
3.2	Material	11
3.3	Pump	11
3.4	Control	12
3.5	External controller	13
3.6	Refrigeration system	13
3.7	Multifunction connector	18
3.8	Mains supply output 34 H	19
3.9	Remote operation (FBC) Option	19
3.10.	SAD-connection to NE 28 (Option)	19
4.	Safety devices and warning notes	21
4.1	Safety functions	21
4.2	Why can a thermostat be dangerous?	21
4.3	Important notes	21
4.4	Warning notes 	22
4.4.1	Temperatures	22
4.4.2	Mains connection	22
4.4.3	Mains cable	22
4.4.4	Fume extraction	22
4.4.5	Steam production	22
5.	Bath liquids and hose connections	23
5.1	Bath liquids	23
5.2	Hose connections	24
6.	Unpacking, assembly and setting up	26
6.1	Unpacking	26
6.2	Setting up, operation as bath thermostat	26
7.	Connection of external systems	27
7.1	Closed external circuits	27
7.2	Open systems (baths)	27
8.	Starting up	30
8.1	Filling	30
8.2	Connection to supply	30
8.3	Basic functions	30

8.4	External control	32
8.5	Operation with programmer	32
8.6	Safety circuit	33
9.	Maintenance	34
9.1	Safety notes in case of repairs	34
9.2	Repairs	34
9.3	Maintenance of the refrigeration system	34
9.4	Cleaning	35
9.5	Spares ordering	35

Appendix

Accessories

Circuit diagrams

1. Brief operating instructions

- ◆ Even if you find these brief instructions initially sufficient please read the following sections, especially Section 4: "Safety devices and warning notes". For safe operation of the equipment it is essential that the information in these Operating Instructions is observed.
- ◆ Check thermostat and accessories during unpacking for any transport damage and if necessary inform the carrier or the postal authority.
- ◆ Assemble the unit according to Section 6 and add extra items as appropriate.
- ◆ Fitting the tubing to the pump connections:
Without external system: for improved circulation within the bath remove the closing plugs from the two pump connections, fit the tubing nipples and link them together with e.g. Perbunan tubing (up to 120°C) or better a metal tubing.
Mit With external system: make tubing connections to the external system.
Protect tubing with hose clips against slipping off.
- ◆ Use only softened water or LAUDA bath liquids (Section 5). Fill the bath up to a level about 2 cm below the cover plate.
- ◆ Check the supply voltage against the details on the label. Insert the mains plug.
- ◆ Set the potentiometer EXT  fully anticlockwise to INT!
- ◆ RK- Types RK: switch on the unit with the mains switch (green lamp lights up).
Types RC and RL: Working without refrigeration (operating temperatures above approx. 40°C).

Mains switch (green) on I (ON) (green lamp lights up)

"Cooling" switch (yellow)  on 0 (OFF)



Working with refrigeration (operating temperature below approx. 40°C)



Mains switch (green) on I (ON) (green lamp lights up)

"Cooling" switch (yellow)  on I (ON).

When starting up the refrigeration unit after it has been off for a longer period it may take up to 20 min., depending on ambient temperature and equipment type, until the normal cooling performance is available.

- ◆ Move the temperature setting to the required temperature.

Pressing the key  shows the operating temperature setpoint on the display. The adjustment is made on the potentiometer . Release the locking device before moving this control.

- ◆ Set the overtemperature protection at the control  to some value above the setpoint. When the red signal lamp lights up, reset the system by pressing the reset key .

- ◆ When connecting up an external system, ensure that filling this system does not cause the level inside the thermostat to fall more than is permitted.

If the setpoint of the bath liquid is reached, the yellow pilot lamp "Heating"  starts to flash.

Having settled the digital thermometer displays the setpoint.

- ◆ Operating safety

The thermostat must be operated only with non-flammable bath liquids, or with flammable bath liquids up to no more than 25 K below their flashpoint, otherwise there is a possibility that a flammable atmosphere may form (see Item 4.2).

- ◆ **WARNING**

Parts of the bath cover may reach temperatures above 70°C when working at higher temperatures. The outflow and return pipes of the pumps reach the operating temperature. Touching them is dangerous because of high or low temperatures!

2. Technical Data to DIN 58966

Type		RC 6 CS	RC 20 CS	RC 25 CS	RL 6 CS	RL 7 CS
Operating temperature range	(°C)	-35...150	-35...150	-35...150	-80...100	-85...100
Ambient temperature range	(°C)	5...40	5...40	5...40	5...40	5...40
Temperature setting/ resolution	(°C)	digital with 10-turn potentiometer and numerical display/ 0.1 °C				
Bath temperature measurement		built-in digital thermometer with LED display ; 0.1°C resolution; absolute accuracy better than 0.2% of reading \pm 0.2 K*); temperature probe Pt 100 to DIN IEC 751				
External temperature measurement		built-in separate measuring system using external Pt 100 to DIN IEC 751; 4-wire circuit; can be switched to LED display; accuracy 0.05% of reading \pm 0.1 K (without temperature probe)				
Temperature control		PID controller with adjustable external proportion and adjustable Xp				
Temperature variation at -10°C in the bath	(±°C)	0.02*)	0.02*)	0.02*)	0.02...0.05*)	0.02...0.05*)
Heater power, max.	(kW)	2	2	2	1.2	1.2
Effective cooling capacity with ethanol at 20°C ambient temperature	20°C	0.3	0.3	0.3	0.46	0.46
	0°C	0.24	0.24	0.24	0.38	0.38
	-30°C	0.1	0.1	0.1	0.30	0.30
	-40°C	----	----	----	0.27	0.27
	-50°C	----	----	----	0.25	0.25
	-60°C	----	----	----	0.23	0.24
	-70°C	----	----	----	0.17	0.19
-80°C	----	----	----	0.05	0.11	
Safety system		adjustable overtemperature protection and low-level protection to EN 61010 (DIN 12879 class 2)				
Pump output against zero head						
Pressure/Suction max. pump pressure	(l/min) (bar)	20/16 0.32/0.25	20/16 0.32/0.25	20/16 0.32/0.25	20/16 0.32/0.25	22/- 0.5/-
Pump connections		M 16x1; nipples Ø13	M 16x1; nipples Ø13	M 16x1; nipples Ø13	M 16x1; nipples Ø13	M 16x1; nipples Ø13
Filling volume max.	(L)	4...6	10...14	19...27	4...6	4...6
Bath opening (B x T)	(mm)	150x130	300x175	300x350	120x105	120x105
Bath depth	(mm)	160	160	200	190	190
Usable liquid depth	(mm)	140	140	180	150	150
Height to top of bath	(mm)	450	450	575	540	540
Overall size (W x D) (H)	(mm)	280x375	550x735	375x590	495x615	495x615
		650	650	775	740	740
Weight	(Kg)	35	42	54	98	98
Supply	(V;Hz)	230; 50	230; 50	230; 50	230; 50	230; 50/60
		230; 60	230; 60	230; 60	230; 60	
Protection class 1 nach VDE 106						
Loading (max.) without accessories	(kW)	2.4	2.5	2.5	2.5	2.5
Current take-up (max.) with accessories	(A)	15	15	15	16	16
Nominal current of fuses on customer's side	(A)	T 16 A	T 16 A	T 16 A	T 16 A	T 16 A
Units are conform to EU Guideline 89/336/EWG (EMC) and 73/23/EWG (low-voltage) and carry the CE mark (230 V; 50 Hz).						
Ref.-No.						
230V; 50Hz		LCK 170	LCK 172	LCK 174	LCK 182	----
230V; 60Hz		LCK 270	LCK 272	LCK 274	LCK 282	----
230V; 50/60Hz		----	----	----	----	LCK 085

Units of different power supplies have different heating capacities as well as different values for power consumption (see type table)!

*) siehe 4.3

Technical changes reserved!

LAUDA Low-temperature thermostats
 RC 6 CS, RC 20 CS, RC 25 CS, RL 6 CS,
 RL 7 CS, RK 8 CS, RK 8 KS, RK 20 KS

Typ		RC 8 CS	RC 8 KS	RK 20 KS
Operating temperature range		(°C) -50...150	-45...150	-40...150
Ambient temperature range		(°C) 5...40	5...40	5...40
Temperature setting/ resolution		(°C)	digital with 10-turn potentiometer and numerical display/ 0.1 °C	
Bath temperature measurement		built-in digital thermometer with LED display ; 0.1°C resolution; absolute accuracy better than 0.2% of reading \pm 0.2 K*); temperature probe Pt 100 to DIN IEC 751		
External temperature measurement		built-in separate measuring system using external Pt 100 to DIN IEC 751; 4-wire circuit; can be switched to LED display; accuracy 0.05% of reading \pm 0.1 K (without temperature probe)		
Temperature control		PID controller with adjustable external proportion and adjustable Xp		
Temperature variation at -10°C in the bath		(±°C) 0.02*)	0.02*)	0.02*)
Heater power, max.		(kW) 2	2	2
Effective cooling capacity with ethanol at 20°C ambient temperature	20°C	(KW) 0.8	0.8	0.8
	0°C	0.7	0.7	0.7
	-30°C	----	----	----
	-40°C	0.14	0.12	0.12
	-50°C	0.03	----	----
	-60°C	----	----	----
	-70°C	----	----	----
-80°C	----	----	----	
Safety system		adjustable overtemperature protection and low-level protection to EN 61010 (DIN 12879 class 2)		
Pump output against zero head				
Pressure/Suction max. pump pressure		(l/min) 20/- (bar) 0.3/-	24/18 0.5/0.34	24/18 0.5/0.34
Pump connections		M 16x1; nipples Ø13	M 16x1; nipples Ø13	M 16x1; nipples Ø13
Filling volume max.		(L) 5.5...8	5.5...8	11...18
Bath opening (B x T)		(mm) 150x130	150x130	300x175
Bath depth		(mm) 200	200	200
Usable liquid depth		(mm) 180	180	180
Height to top of bath		(mm) 575	575	575
Overall size (W x D) (H)		(mm) 400x500 775	400x500 775	400x500 775
Weight		(Kg) 62	62	62
Supply		(V;Hz) 230; 50 230; 60	230; 50 230; 60	230; 50 230; 60
		Protection class 1 nach VDE 106		
Loading (max.) without accessories		(kW) 2.7	2.7	2.7
Current take-up (max.) with accessories		(A) 16	16	16
Nominal current of fuses on customer's side		(A) T 16 A	T 16 A	T 16 A
		Units are conform to EU Guideline 89/336/EWG (EMC) and 73/23/EWG (low-voltage) and carry the CE mark (230 V; 50 Hz).		
Ref.-No.				
230V; 50Hz		LCK 176	LCK 178	LCK 180
230V; 60Hz		LCK 276	LCK 278	LCK 280

Units of different power supplies have different heating capacities as well as different values for power consumption (see type table)!

*) siehe 4.3

Technical changes reserved!

LAUDA Low-temperature thermostats
 RC 6 CS, RC 20 CS, RC 25 CS, RL 6 CS,
 RL 7 CS, RK 8 CS, RK 8 KS, RK 20 KS

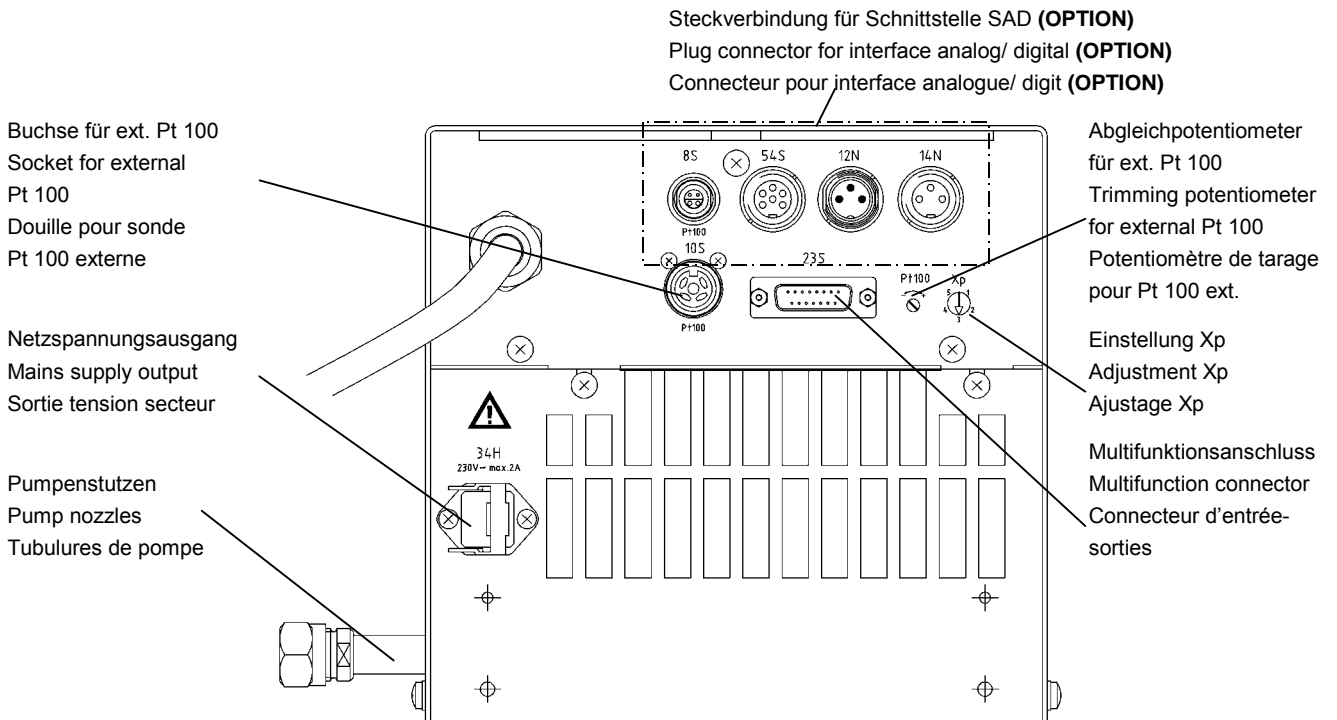
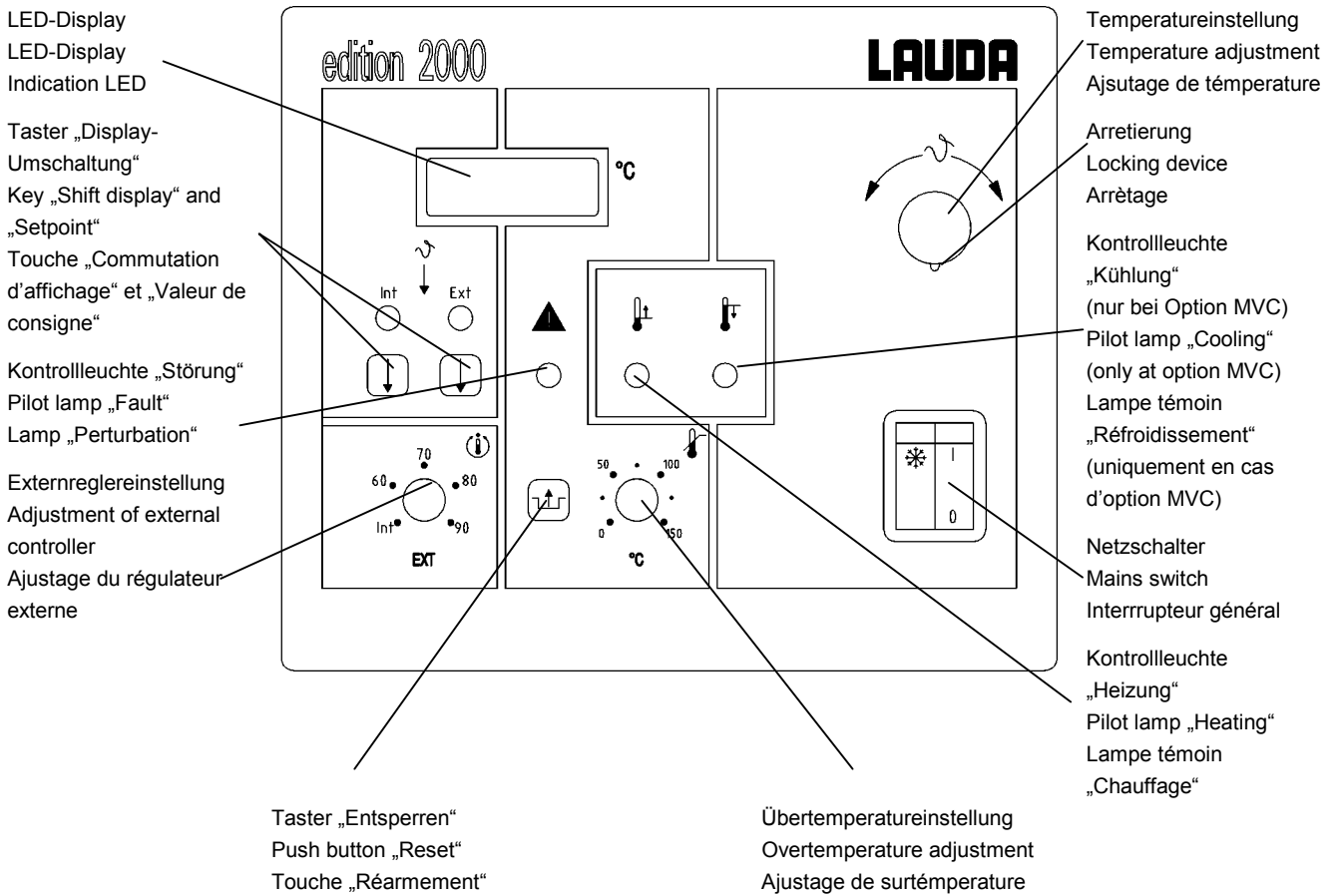

LAUDA Low-temperature thermostats
 RC 6 CS, RC 20 CS, RC 25 CS, RL 6 CS,
 RL 7 CS, RK 8 CS, RK 8 KS, RK 20 KS

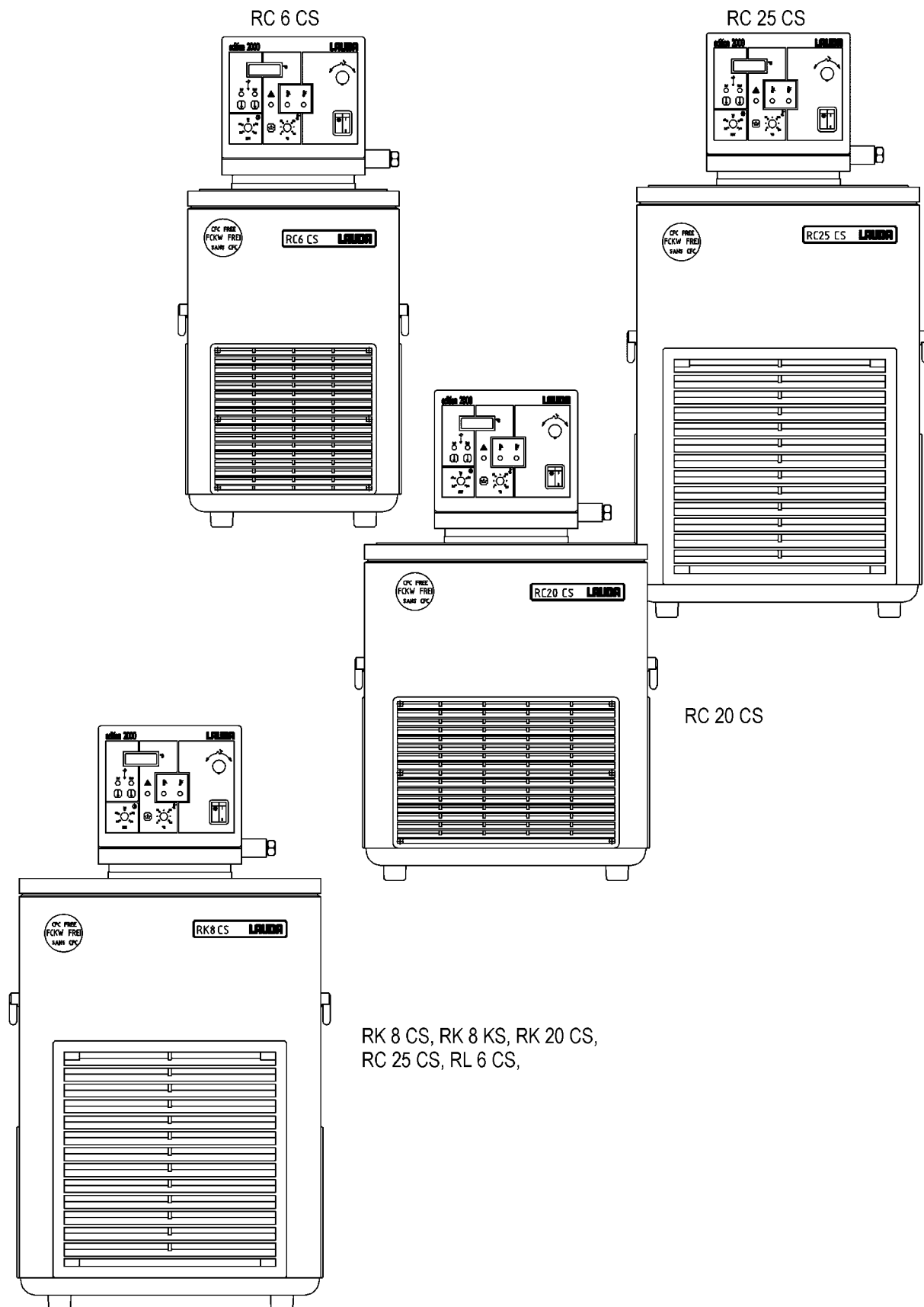

3. General construction and technical description

3.1 *Operating principle*

The LAUDA bath/circulation thermostats Series RC, RL and RK with Electronics S differ in bath volume, bath depth, pump type and output as well as in cooling capacity and working temperature range (see also Item 3.6).

Laboratory thermostats operate with liquids (operating medium, heat transfer fluid) which serve for energy transfer to the product to be thermostated.

The thermostated products can be immersed in the thermostatic bath (bath thermostat), or placed in an external open bath whose liquid is circulated by the pump of the thermostat. When operating as circulator the thermostatic liquid is pumped through an external heat exchanger arranged by the user in which the product is being thermostated (jacketed vessels, reactors, heat exchangers).

3.2 *Material*

All materials in contact with the bath liquid are made from high-grade stainless steel or materials of similar anti-corrosion properties. Materials of PTFE and PETP are also used in the thermostats Series RL.

3.3 *Pump*

All units except Type RK 8 CS are equipped with a centrifugal pressure/suction pump. This can be used to operate both external open baths and closed external systems (reactors).

The immersion pumps are supplied in the two performance classes C and K. The thermostat RK 8 CS is fitted with a pure pressure pump since this unit operates specially with external circulation

The pumps are driven by external-runner motors with a continuous shaft (except for RL). The pumps operate perfectly up to a viscosity of approx. 70 mm²/s (RK 8 CS approx. 120 mm²/s), with the pump output decreasing rapidly with increasing viscosity.

Pump characteristic

230 V; 50 Hz

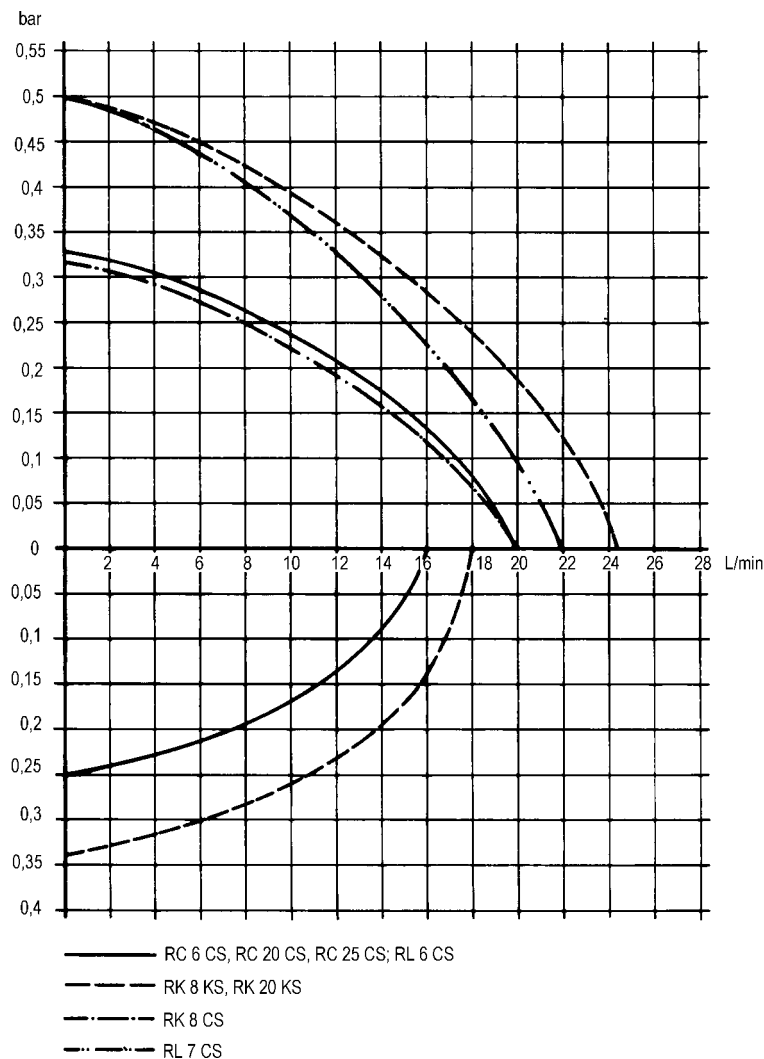

3.4 Control

The units employ a Pt 100 resistance thermometer for measuring the bath temperature. The temperature is indicated on a green LED display. The setpoint is selected on a 10-turn precision potentiometer with locking device and is indicated on the LED display. A PID controller produces fully electronic control of the tubular heater (in the bath) using a triac with burst firing action. Tubular heaters with a surface loading of approx. 6 W/cm² are employed.

3.5 External controller

An additional signal circuit permits connection of an external Pt 100 resistance thermometer to DIN IEC 751 whose indication can be switched to the display; a proportion of this signal can be coupled into the control system. This arrangement greatly reduces the influence of disturbances on the temperature in the external consuming device. The external measurement is also available on the multifunction connector 23 S (see Item 3.7).

Pin connections socket 10 S Pt 100

Pin 1	+ I	current path
Pin 2	+ U	voltage path
Pin 3	- I	current path
Pin 4	- U	voltage path

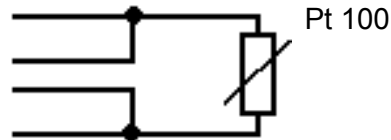

4-pin plug for Pt 100 connection

Cat. No. EQS 014

Use screened connecting cables. Connect screen to plug case. Cover connectors not in use with protective caps!

3.6 Refrigeration system

The refrigeration system consists essentially of a hermetically sealed compressor. The condensation and motor heat is dissipated through a fan cooled finned tube condenser. Fresh air is drawn in at the front, heated and discharged at the back and the sides. To ensure problem-free air circulation the ventilation openings must not be restricted.

The compressors are fitted with a temperature monitor which responds to the compressor temperature and its current take-up. The cooling system is additionally protected against excessive pressure by a pressure monitor.

RC-units

For working temperatures below approx. 40°C the refrigeration system is running continuously and removes a certain amount of heat from the bath, the heater operates against this with the heating power which is automatically adjusted by the control circuit.

RL-units

Thermostats Series RL work with continuous heating (similar to RC units). Their refrigeration unit consists of a two-circuit cascade with electronic starting control of the low-temperature stage.

RK-units

The more powerful refrigeration unit is operated by the automatic electronic compressor control. The LAUDA proportional cooling system controls the cooling capacity through solenoid valves with sound insulation, using the PID temperature controller. This ensures minimum energy consumption and minimal environmental warming on fully automatic operation over the entire working temperature range with differing load conditions.

Diagram cooling circuit

RC

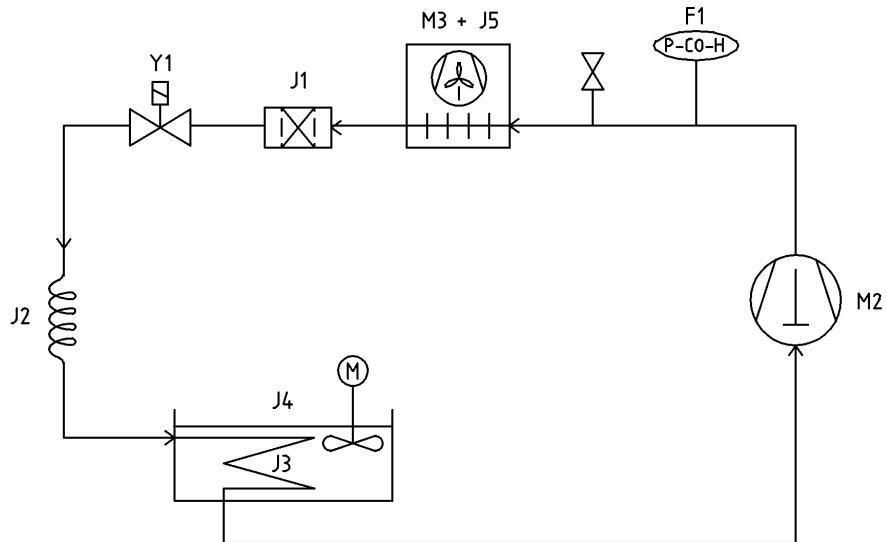

F 1	Überdruckschalter	Overpressure switch	Disjoncteur de surpression
J 1	Trockner	Drier	Secheur
J 2	Kapillarrohr	Capillary	Tube capillaire
J 3	Verdampferschlange	Evaporator coil	Evaporateur à serpentins
J 4	Flüssigkeitsbad	Liquid bath	Bain de liquide
J 5	Verflüssiger	Condenser	Condensateur
M 2	Verdichter	Compressor	Compresseur
M 3	Ventilator	Fan	Ventilateur

RK

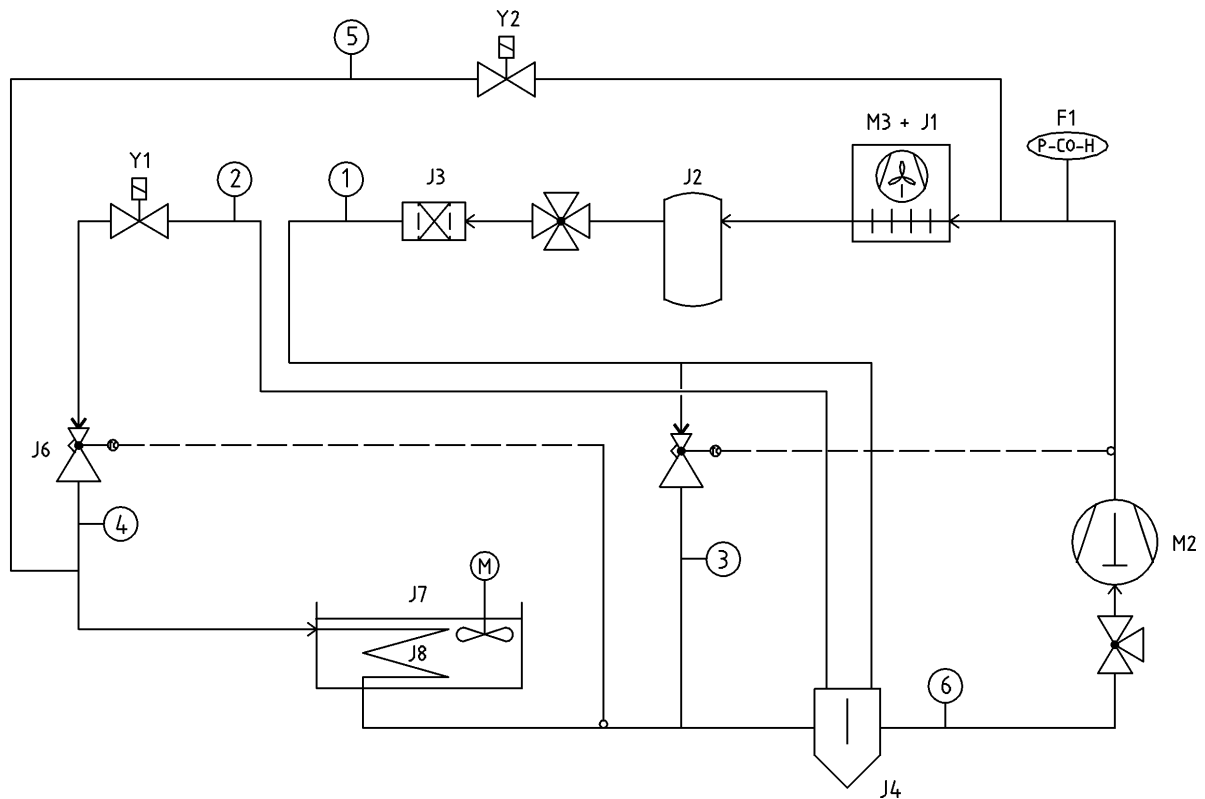

F 1	Überdruckschalter	Overpressure switch	Disjoncteur de surpression
J 1	Verflüssiger	Condenser	Condensateur
J 2	Sammelflasche	Receiver	Récepteur
J 3	Trockner	Drier	Secheur
J 4	Flüssigkeitsabscheider	Liquid separator	Séparateur de liquide
J 5	Nachspritzventil	Re-injection valve	Soupe de ré-injection
J 6	Einspritzventil	Injection valve	Soupe d'injection
J 7	Flüssigkeitsbad	Liquid bath	Bain de liquide
J 8	Verdampfer	Exchanger	Echangeur
M 2	Verdichter	Compressor	Compresseur
M 3	Ventilator	Fan	Ventilateur
Y 1	Magnetventil Kühlen	Solenoid valve cooling	Vanne solenoide réfroidissement
Y 2	Magnetventil Heißgas	Solenoid valve hot gaz	Vanne solenoide

RL

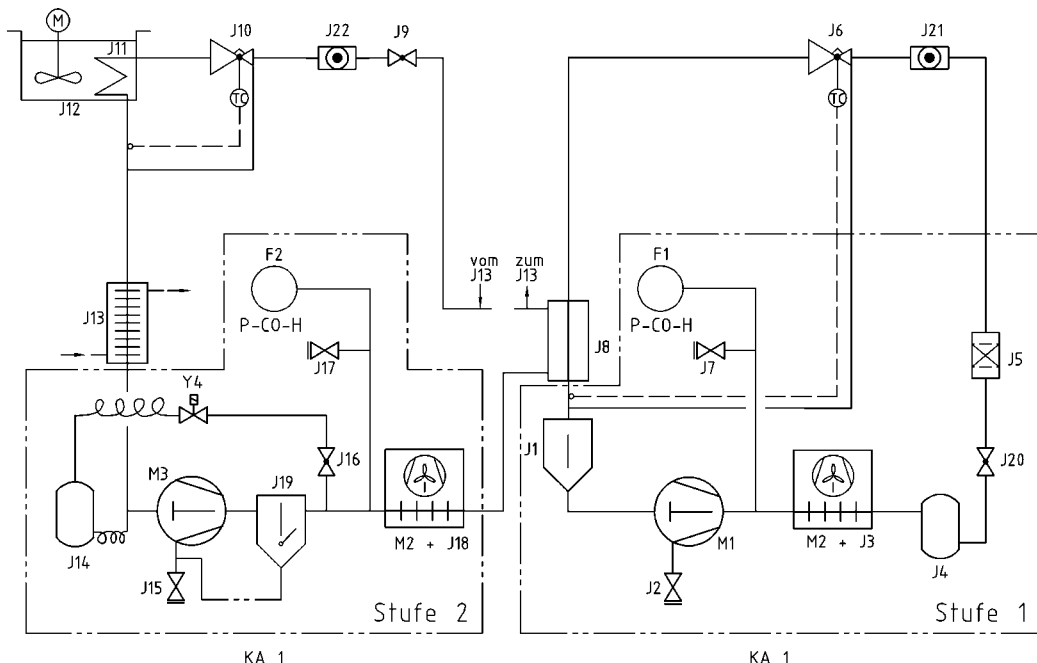

	KA 1		KA 1
F 1	Überdruckschalter Stufe 1	Overpressure switch stage 1	Disjoncteur de surpression étage 1
F 2	Überdruckschalter Stufe 2	Overpressure switch stage 2	Disjoncteur de surpression étage 2
J 1	Flüssigkeitsabscheider	Liquid separator	Séparateur de liquide
J 2	Kontrollventil Saugseite Stufe 1	Control valve suction stage 1	Vanne de contrôle aspiration étage 1
J 3	Verflüssiger Stufe 1	Condenser stage 1	Condensateur étage 1
J 4	Sammelflasche	Receiver	Receveur
J 5	Filtertrockner	Filter drier	Déshydrateur
J 6	Expansionsventil Stufe 1	Expansion valve stage 1	Vanne d'expansion étage 1
J 7	Kontrollventil Druckseite Stufe 1	Control valve pressure stage 1	Vanne de contrôle pression étage 1
J 8	Wärmetauscher Verdampfer Stufe 1 Verflüssiger Stufe 2	Heat exchanger Exchanger stage 1 Condenser stage 2	Echangeur thermique Echangeur étage 1 Condensateur étage 2
J 9	Absperrventil	Shut-off valve	Vanne d'arrêt
J 10	Expansionsventil Stufe 2	Expansion valve stage 2	Vanne d'expansion étage 2
J 11	Verdampfer	Exchanger	Echangeur
J 12	Flüssigkeitsbad	Liquid bath	Bain de liquide
J 13	Wärmetauscher Flüssigkeitsunterkühler Stufe 2	Heat exchanger Liquid refrigerant pre-cooler stage 2	Echangeur thermique Surrefroidisseur Liquide réfrigérant étage 2
J 14	Druckausgleichsbehälter	Surge vessel	Réservoir d'égalisation de pression
J 15	Kontrollventil Saugseite Stufe 2	Control valve suction stage 2	Vanne de contrôle aspiration étage 2
J 16	Absperrventil	Shut-off valve	Vanne d'arrêt
J 17	Kontrollventil Druckseite Stufe 2	Control valve pressure stage 2	Vanne de contrôle pression étage 2
J 18	Wärmetauscher Enthitzer Stufe 2	Heat exchanger Heat remover stage 2	Echangeur thermique Extracteur de chaleur étage 2
J 19	Ölabscheider	Oil separator	Séparateur d'huile
J 20	Absperrventil	Shut-off valve	Vanne d'arrêt
J 21	Schauglas Stufe 1	Sight glass stage 1	Voyant étage 1
J 22	Schauglas Stufe 2	Sight glass stage 2	Voyant étage 2
M 1	Verdichter Stufe 1	Compressor stage 1	Compresseur étage 1
M 2	Ventilator	Fan	Ventilateur
M 3	Verdichter Stufe 2	Compressor stage 2	Compresseur étage 2
Y 4	Magnetventil Druckausgleich	Solenoid valve pressure compensation	Vanne solenoide compensation de pression

Cooling diagram

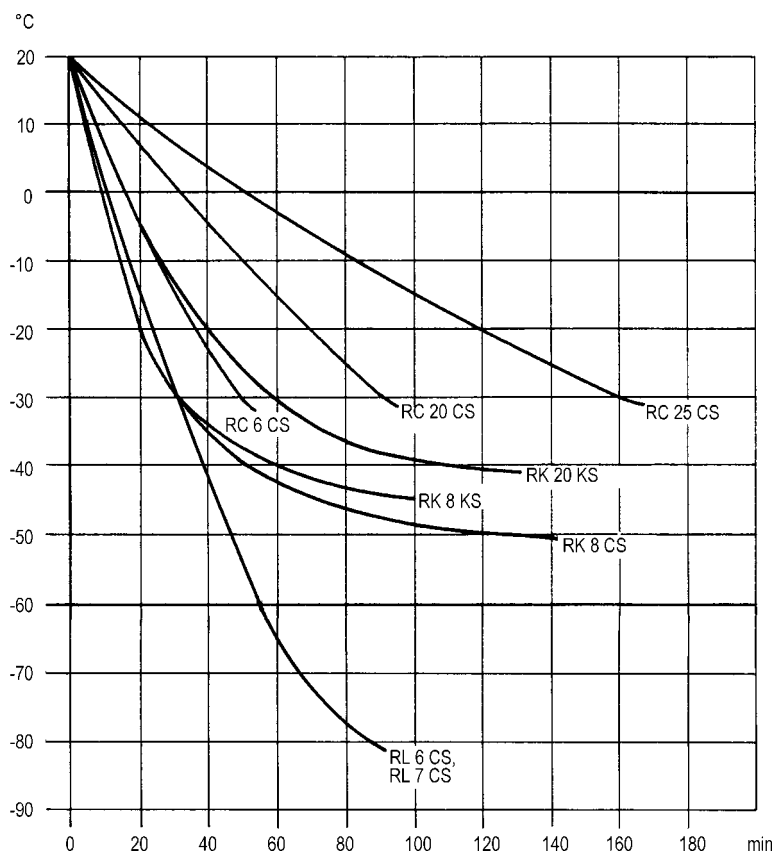

Bath liquid: Ethanol



Refrigerant:
water-Glycol 1:1
(to -25°C)

Time for diagram
= x 1,7

3.7 Multifunction connector

15-pin connector 23 S on the back, with multiple function.

Use screened connecting cables. Connect screen to plug case. Cover connectors not in use with protective caps!

- Pin 1: bath temperature recorder connection, correct sign; 10 mV/K;
Ri \approx 100 Ohm, internal recorder resistance \geq 1 MOhm (0V pin 3)
- Pin 2: Pt 100 EXT; 4-wire; - current path
- Pin 3: 0V reference potential for measurement signals 
- Pin 4: programme or external setpoint input 10 mV/K, added to the selected setpoint. The sum of both setpoints is displayed on pressing key .
Ri = 20 kOhm (0V pin 3)
- Pin 5: output signal, only for accessory units (0V pin 12)
- Pin 6: setpoint output 10 mV/°C, Ri \approx 100 Ohm.
Load resistance \geq 10 kOhm (0V pin 3)
- Pin 7: +12 V supply voltage, max. additional loading 20 mA
- Pin 8: reference voltage approx. 5 V, load resistance \geq 10 kOhm
(0V pin 3)
- Pin 9: Pt 100 EXT; 4-wire; - voltage path
- Pin 10: -12 V supply voltage, max. additional loading 20 mA (0V pin 12)
- Pin 11: Pt 100 EXT; 4-wire; + current path
- Pin 12: 0V- load reference potential 
- Pin 13: 18 V, if red fault lamp is alight, i.e. safety circuit to DIN 12879 has operated. Ri \approx 1 kOhm; I max = 10 mA (0V pin 12)
- Pin 14: recorder connection for external temperature, correct sign, 10 mV/K,
Ri \approx 100 Ohm; internal recorder resistance \geq 1 MOhm (0V pin 3)
- Pin 15: Pt 100 EXT; 4-wire; + current path

Pins 2, 9, 11 and 15 Pt 100 EXT are parallel to socket 10 S. They must not be connected up if socket 10 S is in use.

In case of a fault the signals appearing at this connector can usefully be employed for the initial investigation of the fault.

15-pin connector

Cat. No. EQM 030

Housing for above

Cat. No. EQG 017

3.8 Mains supply output 34 H

The 230 V supply voltage is available at the socket 34 H at the back in normal operation and with the unit switched on. The maximum current which can be drawn there is 2 A. In case of a fault this voltage is switched off. This output can be used e.g. to connect a non-return fitting (Cat. No. UD 125).

Suitable mating plug

Cat. No. EQS 045

3.9 Remote operation (FBC) Option

As an option the units can be converted for remote control; the entire electronics with control panel is removed from the unit and used for remote operation. An adapter for the cable connections is required on the basic unit and the control panel is placed in an extra housing. The conversion must be carried out by a qualified electrician. All necessary components except for the connection cables are supplied as part of the kit. Please specify the length of the connection cables.

Conversion kit for remote operation FBC

Cat. No. LCZ 960

Set of cables for remote operation FBC
 5 m long

Cat. No. UK 235

Set of cables for remote operation FBC
 length as specified

Cat. No. UK 238

19" adapter to take the control panel
 of the remote operation system FBC 5 HE
 for one or two panels

Cat. No. LRZ 009

3.10. SAD-connection to NE 28 (Option)

The connector according to NAMUR recommendation NE 28 is located at the back of the control unit if option SAD is fitted.

Use screened connecting cables. Connect screen to plug case. Cover connectors not in use with protective caps!

8 S: Pt 100 connection (EXT) (Lemos plug)

- | | | |
|---|---|-----------------|
| 1 | = | Pt 100 (EXT) I+ |
| 2 | = | Pt 100 (EXT) U+ |
| 3 | = | Pt 100 (EXT) U- |
| 4 | = | Pt 100 (EXT) I- |

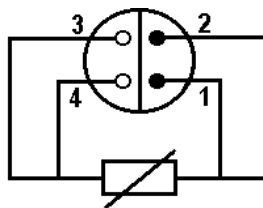

4-pin plug for Pt 100 conne

Cat. No. EQS 022

Note: only one of the Pt 100 inputs, socket 10 S or 8 S, may be used at a time!

54 S: signal connection

- 1 = external temperature 0 - 10 V (0 V = -100°C / 10 V = 400°C)
- 2 = internal temperature 0-10 V (0 V = -100°C / 10 V = 400°C)
- 3 = earth of measurement signals (pin 1, 2, 5)
- 4 = control signal 4 - 20 mA (4 mA = -100°C / 20 mA = 400°C).
at 0°C setpoint setting!
- 5 = control signal 10 mV/°C (parallel to MF 23 S pin 4)
- 6 = earth of the control signal (linked int. to pin 3)

6-pin mating plug

Cat. No. EQS 057

Note: of the three control signal (programmer) inputs (23 S pin 4, 54 S pin 4 and 5) only one pin may be used at a time!

12 N: floating contact general fault

- 1 = n.o. (closing)
- 2 = common
- 3 = n.c. (opening)
- 1, 2 = are closed under normal conditions

3-pin mating socket

Cat. No. EQD 047

14 N: contact input, fault

- 1 = n.o. (closing)
 - 2 = common
 - 3 = not used
- mating plug with link 1, 2 is included in the unit

3-pin mating plug

Cat. No. EQS 048

Interface SAD to NE 28
factory fitted or retrofit kit

Cat. No. LCZ 959

4. Safety devices and warning notes

4.1 Safety functions

The built-in overtemperature limiter is adjustable with a tool (screwdriver) between 0°C and 150°C (resp. 100°C). The bath temperature is sensed by a separate Pt 100 resistance thermometer and processed by a separate electronics. When exceeding the set switching point the unit is switched off permanently on all poles (limiter function).

The red signal lamp  lights up and at the multifunction connector 23 S a signal of approx. 18 V appears at contact 13.

A float switch with magnetic coupling acts as low-level cut-out and also switches off the unit (pump and heater) permanently on all poles.

The switch-off function of the safety circuit remains stored during a break in the supply or after switching off the supply.

Reset is possible only after rectifying the fault, using the reset key .

The safety devices are conform to EN 61010-2-010.

The pump motor is fitted with a temperature monitor which switches off if the motor winding overheats. The heater is also switched off simultaneously. After the motor winding has cooled down the pump starts up automatically.

4.2 Why can a thermostat be dangerous?

Thermostats are equipped with heaters which supply the necessary heat to the thermostating liquid. If the temperature control fails or if the liquid level is too low, the heater may reach temperatures which can lead to a fire in the laboratory, especially in combination with flammable liquids.

When using the thermostat as a circulation thermostat a hose may break, causing hot liquid to spill and endangering people and goods.

The safety requirements on thermostats therefore depend on whether

- non-flammable or flammable liquids are used
- operation is with or without supervision.

The thermostats described in these Operating Instructions are protected against overtemperature and low liquid level if used according to the descriptions indicated in these Operating Instructions.

The units can be operated with non-flammable bath liquids, and with flammable bath liquids up to 25 K below their flashpoint (EN 61010), while DIN 12879 requires a safety spacing of only 5 K to the flashpoint. In each case it is assumed that there is correct adjustment and regular testing (see Item 8.6) of overtemperature and low-level protection.

4.3 Important notes

The user is only protected against those hazards which are caused by exceeding the temperature and by low liquid level.

Further hazards may arise from the type of product being thermostated, e.g. a shift above or below certain temperature levels or fracture of the container and a reaction with the thermostatic liquid etc.

Values for temperature variation and indication accuracy apply under normal conditions according to DIN 58966. In special cases high-frequency electromagnetic fields may lead to less favourable values. There is no loss of safety.

Units are in accordance with EMC directive EN 61326-1, class A *:

Units are only suitable for use in industrial areas as disturbing voltage fluctuations might occur.

Warning: The units must only be used according to the descriptions indicated in the Operating Instructions.

This includes operation by properly qualified and instructed personnel.

The units are not designed for operation under medical conditions according to EN 60601-1 or IEC 601-1!

4.4 Warning notes

4.4.1 Temperatures

Parts of the bath cover may reach temperatures above 70°C when working at higher temperatures. The outflow and return pipes of the pumps reach the operating temperature. Touching them is dangerous because of high or low temperatures!

4.4.2 Mains connection

Connect the unit only to mains sockets with protective earth contact (PE) which must not have a fuse higher than T 16 A!

4.4.3 Mains cable

We have ensured that the mains cable and other plug connections do not touch any hot parts. Please check that there is no contact between the connecting tubings filled with hot liquid, other hot parts and the mains cable!

4.4.4 Fume extraction

Depending on the bath liquid used and the operating method there is a possibility that toxic vapours may be produced. In that case it is necessary to provide appropriate fume extraction. Pull out the mains plug before cleaning the bath with solvents. Provide appropriate fume extraction. Before starting up the unit it is absolutely essential to ensure that the bath contains no explosive mixture. If necessary purge it with nitrogen!

4.4.5 Steam production

When changing the bath liquid from water to heat transfer fluids for temperatures above 100°C any remaining water - including the one in the hoses and external system - has to be removed completely. Otherwise there is a danger of burns because of delayed boiling.

* Notice only valid for EU countries

5. Bath liquids and hose connections

The operating temperature ranges specified for the bath liquids and the tubings are for general information only and may be restricted through the operating temperature range or safety requirements specified in the appropriate standards (see Item 4.2).

5.1 Bath liquids

LAUDA Designation		Working temperature range	Chemical Designation	Viscosity (kin)	Viscosity (kin) at Temperature	Fire-point	Ref.No. Quantity		
	Former designation	from °C to °C	at 20°C	mm ² /s	mm ² /s		5 l	10 l	20 l
	Water	+5...+90	deionised water ①	--	--	--			
Kryo 20	160 MS	-20...+180	Silicone oil	11	28 at -20°C	> 230	LZB 116	LZB 216	LZB 316
Kryo 30 ②	G 100 ②	-30...+90	Mono-ethylene-glycol/water	4	50 at -25°C	--	LZB 109	LZB 209	LZB 309
Kryo 85	Ultra-Therm XLT	-85...+30	Silicone oil	1,76	17 at -80°C	> 56	LZB 113	LZB 213	LZB 313
Ultra 350	330 SCB	+30...+200	synthetic thermal oil	47	28 bei +30°C	> 240	LZB 107	LZB 207	LZB 307
Ultra 300	Ultra-Therm SW 300N	+80...+300	Silicone oil	170	35 ... +80°C	> 400	LZB 108	LZB 208	LZB 308



① At higher temperatures → Evaporation losses → Use bath covers (➤ Section 10. Accessories). Distilled water or fully deionised water must only be used with the addition of 0.1g sodium carbonate (Na₂CO₃) /l water, otherwise → danger of corrosion!

② Water content falls after prolonged operation at higher temperatures → mixture becomes flammable (flash point 128 °C).
 → Check the mixture ratio with a densitometer.

- When selecting bath liquids it should be noted that performance must be expected to worsen at the lower limit of the operating temperature range due to increasing viscosity. The full operating range should only be utilised if really necessary.
- The operating ranges of the bath liquids and tubing represent general data which may be limited by the operating temperature range of the unit.



Silicone oil causes pronounced swelling of Silicone rubber → never use Silicone oil with Silicone tubing!

DIN Safety data sheets are available on request!

5.2 Hose connections

Tubing type	Int. dia. Ø mm	Temperature range °C	Application	Ref. No.
EPDM-tubing uninsulated	9	10...120	for all bath liquids except Ultra 350 and mineral oils	RKJ 111
EPDM-tubing insulated	9	-60...120	for all bath liquids except Ultra 350 and mineral oils	LZS 019
EPDM-tubing uninsulated	12	10...120	for all bath liquids except Ultra 350 and mineral oils	RKJ 112
EPDM-tubing insulated	12 ext. dia. 35mm approx.	-60...120	for all bath liquids except Ultra 350 and mineral oils	LZS 021
Silicone tubing, uninsulated	11	-30...100	water, water/glycol mixture	RKJ 059
Silicone tubing, insulated	11 ext. dia. 35mm approx.	-60...100	water, water/glycol mixture	LZS 007



- EPDM-tube not for Ultra 350 and mineral oils!
- Silicone oil causes pronounced swelling of Silicone rubber → never use Silicone oil with Silicone tubing!
- Protect tubing with hose clips against slipping off.

Metal hoses single-layer insulation	Tube connection	Ø i (mm)	Ø a (mm)	Temperature range °C	Length	Ref. No.
MC 50	M 16x1	10	18	-10...400	50	LZM 040
MC 100	M 16x1	10	18	-10...400	100	LZM 041
MC 150	M 16x1	10	18	-10...400	150	LZM 042
MC 200	M 16x1	10	18	-10...400	200	LZM 043
Pump link	M 16x1	10	18	-10...400	20	LZM 044

Metal hoses with insulation	Tube connection	Ø i (mm)	Ø a (mm)	Temperature range °C	Length	Ref. No.
MK 50	M 16x1	10	44	-90...150	50	LZM 052
MK 100	M 16x1	10	44	-90...150	100	LZM 053
MK 150	M 16x1	10	44	-90...150	150	LZM 054
MK 200	M 16x1	10	44	-90...150	200	LZM 055
Pump link	M 16x1	10	44	-90...150	20	LZM 045

LAUDA Low-temperature thermostats
 RC 6 CS, RC 20 CS, RC 25 CS, RL 6 CS,
 RL 7 CS, RK 8 CS, RK 8 KS, RK 20 KS

Metal hoses with Insulation	Tube connection	Ø i (mm)	Ø a (mm)	Temperature range °C	Length	Ref. No.
MGK 50	M 19x1,5	12	36	-90...150	50	LZM 056
MGK 100	M 19x1,5	12	36	-90...150	100	LZM 057
MGK 150	M 19x1,5	12	36	-90...150	150	LZM 058
MGK 200	M 19x1,5	12	36	-90...150	200	LZM 059

Metal hoses with triple insulation	Tube connection	Ø i (mm)	Ø a (mm)	Temperature range °C	Length	Ref. No.
MC 50 S	M 16x1	10	34	-60...350	50	LZM 046
MC 100 S	M 16x1	10	34	-60...350	100	LZM 047
MC 150 S	M 16x1	10	34	-60...350	150	LZM 048
MC 200 S	M 16x1	10	34	-60...350	200	LZM 049

Further details on thermostatic liquids and hoses can be found in our special publication.

6. Unpacking, assembly and setting up

6.1 Unpacking

Goods are packed carefully, largely preventing transport damage. If unexpectedly some damage is visible on the equipment, the carrier or the postal authority has to be informed so that it can be inspected.

Standard accessories:

		Ref. No.
1 Bath cover	for RC 6 CS	HDQ 070
1 Bath cover	for RC 20 CS, RK 20 KS	HDQ 067
2 Bath cover	for RC 25 CS	HDQ 067 and HDQ 068
1 Bath cover	for RL 6 CS, RL 7 CS	HDQ 073
1 Bath cover	for RK 8 CS, RK 8 KS	HDQ 042
2 Nipplex 13 Ø		HKO 026
2 Screw caps		HKM 032
2 Closing plugs	nicht bei RK 8 CS	HKN 065
1 Pump link Pump link	bei RK 8 CS	LZM 045
Operating instructions		

6.2 Setting up, operation as bath thermostat

Set up the unit conveniently so that the control panel is towards the front and ensure that the air circulation for the refrigeration system through the grid in the lower part of the unit and the ventilating openings at the back of the unit is not restricted. On air-cooled units a minimum spacing of 40 cm between grid and wall is recommended.

Close the drain cock at the back of the bath!

When operating as bath thermostat - no external system connected up - it is advisable to ensure internal circulation by removing the closing plugs from the pump flow and return connections. Remove the screw caps and link the pump connections together using a piece of tubing. As a permanent arrangement the hose link of flexible insulated metal tubing (Cat. No. LZM 045) is the best and safest solution.

NOTE: When loosening or tightening the screw caps (19 mm a/f), hold the threaded nipple on the tubing connections with a spanner (14 mm a/f)!

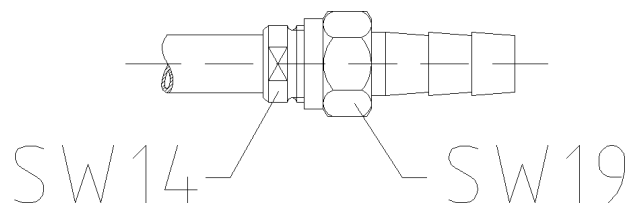

7. Connection of external systems

7.1 Closed external circuits

Remove the closing plugs by releasing the threaded rings (19 mm a/f) from the outflow and return connections and replace them by the tubing nipples (13 mm dia.) supplied. If the thermostat is connected to closed external circuits, additional liquid must be poured in after the thermostat is switched on until the level in the bath remains at the correct height (approx. 2 cm below top plate).

At higher operating temperatures it is necessary to allow during filling for the expected expansion in volume of approx. 8% per 100°C.

For suitable tubing materials see Section 5.

We recommend metal tubings for temperatures above 100°C.

With external systems at a high level it may happen even in closed circuits that the external volume drains down and the thermostat tank overflows if the pump is stopped and air enters the thermostated system!

Always ensure the maximum possible flow area in the external circuit (nipples, tubing, system). This results in a larger flow and therefore improved thermostatic control.

Always protect tubing with hose clips against slipping off, or use stainless steel hoses with screwed connections.

NOTE: When loosening or tightening the screw caps (19 mm a/f) at the tubing connections hold the threaded nipple with a spanner (14 mm a/f)!

7.2 Open systems (baths)

The units (except for RK 8 CS) are equipped with a pressure/suction pump. This can be used for circulation to closed external circuits at higher pump outputs and in particular also to open external baths. There are two possibilities for maintaining the level in external baths:

1. The suction tubing is mounted in the external bath so that its end is at the required liquid level. The flow of the pressure stage is restricted with a tubing clamp on the hose from the pressure connection to the external bath so that the flow of the pressure stage is restricted slightly below that of the suction stage. This becomes noticeable by the entry of air into the suction tubing. This operating method is not recommended, in particular at temperatures below 0°C and when using oil at elevated temperatures
2. The preferred solution is the use of the LAUDA level controller (Cat. No. LPZ 901) which provides the functions of adjustable level control with float, screw-on connection for external bath, and clamp fitting for 4 mm dia. Pt 100 probe.

Fitting the level controller

Ref.No. LPZ 901

The level controller is mounted on the external bath using the screw clamp ①. The mounting is suitable for both round and rectangular baths.

Height adjustment after loosening the screw ②.

Make sure that there is good circulation and that the float can move freely!

Make the hose connections to the thermostat, connect the pressure nipple ④ to the pressure side and the suction nipple ⑤ to the suction side (see diagram).

Clamp fitting for Pt 100 probe (4 mm dia.)

The clamp ⑥ is not required on these units!

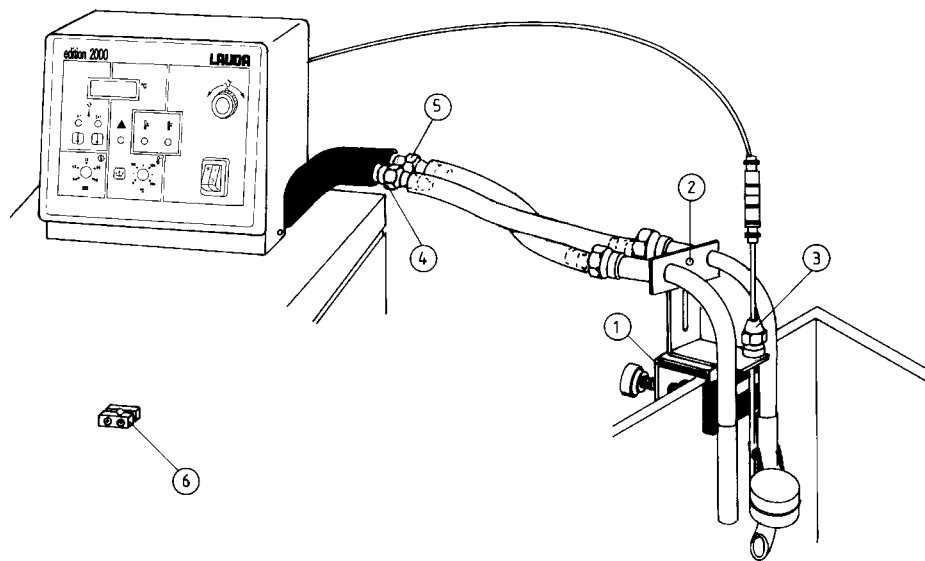

It is advisable to set up the external bath at the same level.

If the difference in level between the open external bath and the thermostat bath is greater than 0.5 m there is the possibility in certain applications that the control range of the level controller is not sufficient. With higher external bath level the suction hose should then be clamped off to such an extent that a constant level in the bath is obtained at which the float is within its control range. If the external level is low the pressure hose has to be similarly restricted by partly clamping it off.

WARNING: If thermostat and external bath are not at the same level it is essential to provide venting of the connecting hoses when the pump is switched off in order to prevent overflowing.

It is preferable to use the Non-Return Fitting (see Accessories) which is mounted at the highest point of hose connection (bath or thermostat connection) and which is linked electrically to the mains output 34 H.

Non-Return Fitting

Ref.No. UD 125

Always protect tubing with hose clips against slipping off, or use stainless steel hoses with screwed connections.

NOTE: When tightening the screw caps (19 mm a/f) at the tubing connections, hold the threaded nipple with a spanner (14 mm a/f)!

8. Starting up

8.1 Filling

Fill the unit with bath liquid to suit the operating temperature, see Section 5. The filling volume is given under Technical data. In general the thermostat must be filled no higher than 2 cm below the cover plate. When working with thermal oils (e.g. Ultra-Therm 330 SCB) slightly less liquid should be used to allow for expansion. The level must obviously not fall below the minimum, otherwise the low-level protection switches off the unit (see Safety circuit). The same applies to filling an external system by the pump during start-up.

8.2 Connection to supply

Connect the unit only to an earthed socket (PE). Compare the details on the label with the mains voltage (see Item 4.4.2).

Model according to EMC directive EN 61326-1 (industrial areas only)!*

When working without external system, ensure that the pump connections are linked together (metal hose link Cat. No. LZM 045), or use the closing plugs.

8.3 Basic functions

Set potentiometer EXT  fully anticlockwise (INT)!

Set the potentiometer for the overtemperature switch-off point to suit the required operating temperature, with due consideration for the bath liquid.

When operating below ambient temperature the overtemperature cut-out setting must of course be above ambient temperature until the operating temperature is reached. Then the switch-off point can be set slightly above the bath temperature (at least approx. 0°C).

Types RK:

Switch on the unit with the mains switch. The green signal lamp lights up. Depending on the temperature setting and the energy demand the refrigeration system switches on automatically.

The signal lamp  indicates the cooling function.

Types RC- and RL:

Working without refrigeration (operating temperatures above approx. 40°C)

mains switch (green) on I (ON) (green lamp lights up)

Cooling" switch (yellow)  on 0 (OFF)

Working with refrigeration (operating temperature below approx. 40°C)



* Notice only valid for EU countries



mains switch (green)  on I (ON) (green lamp lights up)

"Cooling" switch (yellow)  on I (ON)

With thermostats Series RL the green LED  shows the operation of the low-temperature stage.



Depending on the application the low-temperature stage starts running after a period of approx. 10 s to 20 min after the starting of the refrigeration unit.

Briefly press the left key  Int. The bath temperature is indicated. When the red signal lamp lights up, briefly press the reset key .

Using the keys  Int and  the display can be switched to bath temperature (Int) or the temperature of the external Pt 100 (Ext) irrespective of the control mode selected (INT-EXT).

The indication is on the green signal lamps Int and Ext. At the same time the display indicates the setpoint when pressing one of the two keys .

To adjust the setpoint press one of the keys  release the locking device on the setpoint knob and select the setpoint according to the display. Lock the knob again - release the key.

The lamp  shows the operation of the heater. At the control point this lamp flashes according to the heater power, or the lamp  according to the cooling output.

After the operating temperature has been lowered the lamp  obviously starts to flash only after the set temperature has been reached (on Types RC and RL).

The controller gain X_p can be adjusted on the back of the control unit. The adjustment range 1...5 corresponds to a proportional band of 0.4...16°C referred to the heater control signal. The standard setting at which the unit is shipped from the factory is 3. Usually it is not necessary to change the adjustment.

The scale is non-linear with the following values:

X_p	P-Bereich
1	0,4°C
2	1,5°C
3	2,5°C
4	4,5°C
5	16,0°C

If there are any control oscillations, e.g. in small baths with bath liquids of low thermal capacity and high viscosity, Xp is set to the next higher setting (e.g. from 2 to 3).

8.4 External control

Connect the Pt 100 resistance thermometer to socket 10 S (see Item 3.5). Switch over the display by pressing the key  Ext. The temperature display flashes if no external Pt 100 is connected.

Using the potentiometer Pt 100  on the back of the control unit the external Pt 100 can be trimmed to a known temperature. This can be done using the bath temperature, for example, if no other temperature reference is available.

When used with external control, i.e. the measurement point for the control parameter is located outside the thermostat at a point selected by the user, the potentiometer EXT  can be used to select a value between approx. 50% and 90% for the proportion of the external probe.

The closer the external Pt 100 probe is connected with the circulated bath liquid, the higher the external proportion (e.g. 90%) can be chosen. This increases the quality of the control results related to the external measuring points.

Suggested setting for a 2 litre jacketed reactor with water-glycol, external resistance thermometer in the product space, product slightly stirred. EXT  90 %, Xp 2.

With the selected simple control method there remains a permanent deviation between external controlled temperature and setpoint, depending on the proportion of the external measurement parameter; this deviation has to be compensated by re-adjusting the setpoint!

Example: selected potentiometer EXT  80, setpoint 80°C.

After the system has settled down, the external measured temperature is 79.5°C. Increase the setpoint by 0.5 K, then the external measured temperature rises to 80°C.

8.5 Operation with programmer

A programmer Type PM 351-1 can be connected to the multifunction connector 23 S to vary the setpoint of the thermostat according to a given programme. This requires that the energy balance (heating, cooling, load) of the thermostat matches the requirements of the programme (heating rate, cooling rate, operating temperatures). The plug must not be put into 23 S when adjusting the unit setpoint to the lowest temperature of the programme. This value is entered as value A when programming the programmer. Do not change the unit setpoint any more and put in the plug of the programmer connecting cable.



Operation of the push buttons  indicates on the digital display the current setpoint which is provided by the programmer and on which the unit is operating.

For further details refer to the Operating Instructions for the PM 351-1.

8.6 Safety circuit

The operation of the safety devices of the units has already been described in Item 4.1. After starting up the user should confirm the correct operation of the safety devices. If the unit is operating unsupervised we recommend that this check should be carried out daily.

For proper operation of the low-level limiter it is essential that the float switch is operating correctly. This can be checked by draining some of the liquid. When the level drops below the minimum level (about 20 mm above the upper heater winding) the pump and the heater are switched off on all poles.

The pilot lamp "Fault "  For restarting fill in bath liquid and press the Reset key .

To check the overtemperature limiter its switch-off point is gradually reduced.

When it is below the value shown on the digital thermometer the unit must switch off as under Item 8.6.1.

To distinguish between "Overtemperature" and "Level" faults the dot on the right in the display is flashing when the overtemperature switch-off point has been exceeded.

Faults in the temperature probe (break, short circuit) also lead to switch-off and flashing of the right dot in the display.

Set the switch-off point again above the bath temperature and operate the Reset key.

In case of any failure in Items 8.6.1 and 8.6.2 the unit must immediately be taken out of operation and must be tested by a qualified engineer, otherwise its safety is no longer ensured.

9. Maintenance

9.1 Safety notes in case of repairs

Always pull out the mains plug for all repair and cleaning operations! Repairs on the control unit with cover removed must only be carried out by a qualified electrician.

9.2 Repairs

LAUDA thermostats are largely free from maintenance. Dirty thermostatic liquid should be removed through the drain cock and replaced. If the unit should become faulty it may be advisable to return only the faulty module where appropriate.

The control unit can readily be removed after removing the cover, releasing 2 screws ① (2 turns) behind the front panel and 2 screws at the rear and disconnecting the electrical connections ②.

The module with pump, heater, temperature probe etc. can also be easily separated from the bath.

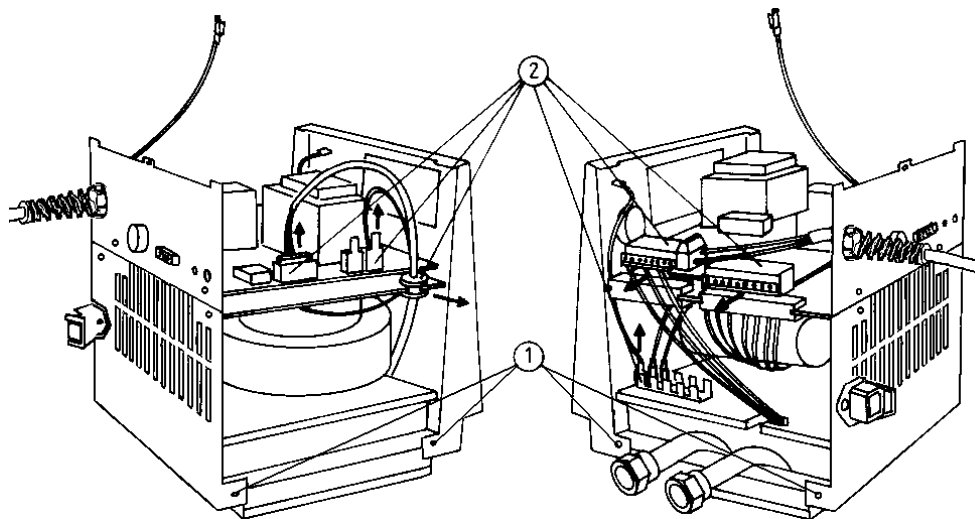

There is no provision for a fuse for the complete unit since the necessary 16A fuse corresponds to the mains fuse usually provided at the location. The control circuit of the unit has a separate fuse; a fuse 5 x 20 F4A is located in the control unit. This is accessible after removing the cover. When the fuse has blown the green lamp in the mains switch does not light up.

9.3 Maintenance of the refrigeration system

The refrigeration system operates largely without maintenance. If the unit is being operated in a dusty atmosphere we recommend cleaning the refrigeration system condenser at intervals of 4 to 6 months. This is best done with compressed air or nitrogen by blowing for a few minutes into the ventilation openings. If necessary unscrew the front grille.

Repair and disposal note

The cooling circuit of the types RC is filled with the CFC-free refrigerant R 404 A (HP 62), the cooling circuit of the types RK is filled with the mixture of refrigerants HP 80. The high-temperature stage of the RL-units is filled with CFC-free refrigerant R 404 A; their low-temperature stage is filled with CFC-free refrigerant R 23. Repair and disposal only by a qualified refrigeration engineer!

9.4 Cleaning

The unit can be cleaned using a cloth moistened with water with the addition of a few drops of (domestic) detergent. No water must find its way into the control unit.

The user is responsible for any necessary decontamination if dangerous materials have been spilled on or inside the unit. This applies in particular if the unit is removed for a different use, for repair, storage etc.

The method of cleaning or decontamination is determined by the expertise of the user himself. If the user has any doubts on whether this may damage the unit he has to contact the manufacturer.

9.5 Spares ordering

When ordering spares please specify the equipment type and number on the label. This avoids queries and prevents supply of incorrect goods!

We shall always be happy to deal with queries, suggestions and complaints.

**LAUDA DR. R. WOBSE
GMBH & CO. KG
P.O.Box 1251
GERMANY
97912 Lauda-Königshofen
Tel: (+49) (0) 9343/ 503-0
Fax: (+49) (0) 9343/ 503-222
E-mail info @ lauda.de
Internet <http://www.lauda.de>**

Accessories for LAUDA Low-Temperature Thermostats RC and RK

RS 232 C Interface R 61/2

Cat. No. LRT 013

Using the RS 232 C (V24) Interface with A/D and D/A converter it is possible with all suitably equipped computers to read out temperatures from the thermostat and to transmit a temperature (setpoint) to the thermostat. In addition the fault signal can be called up.

Programming and automatic running of ramps and contact programming are possible.

Connecting cable PM 351-1 or R 61/2 to thermostat

Cat. No. UK 085

length 1.2 m

Racks in stainless steel
for test tubes, centrifuge tubes etc.

Bath RC 20 up to 2 racks

13	for 56 tubes 10 - 13 dia.,	80 mm immersion	Cat. No. UG 066
RD 18/1	for 33 tubes 14 - 18 dia.,	80 mm immersion	Cat. No. UG 067
RD 18/2	for 33 tubes 14 - 18 dia.,	110 mm immersion	Cat. No. UG 068
RD 30	for 14 tubes 24 - 30 dia.,	110 mm immersion	Cat. No. UG 069

Bath RC 25 up to 4 racks

Bath RK 20 up to 2 racks

RE 13	for 56 tubes 10 - 13 dia.,	80 mm immersion	Cat. No. UG 070
RE 18/1	for 33 tubes 14 - 18 dia.,	80 mm immersion	Cat. No. UG 071
RE 18/2	for 33 tubes 14 - 18 dia.,	110 mm immersion	Cat. No. UG 072
RE 30	for 14 tubes 24 - 30 dia.,	110 mm immersion	Cat. No. UG 073

Bath RC 6 1 rack

RF 18/1	for 20 tubes 14 - 18 dia.,	80 mm immersion	Cat. No. UG 074
RF 18/2	for 20 tubes 14 - 18 dia.,	110 mm immersion	Cat. No. UG 075

Bath RK 8 1 rack

RG 18/1	for 20 tubes 14 - 18 dia.,	80 mm immersion	Cat. No. UG 076
RK 18/2	for 20 tubes 14 - 18 dia.,	110 mm immersion	Cat. No. UG 077

Details of other racks on request

Rising platform for retrofitting

size 250x160 mm, with continuous height adjustment
suitable for:

Cat. No. LCZ 012

Bath RC 20 (1 platform)
Bath RC 25 (2 platforms)
Bath RK 20 (1 platform)

<u>Gable cover</u> , stainless steel for RC 25	Cat. No. LCZ 011
<u>Gable cover</u> , stainless steel for RC 25 (Beer forcing test for bottles of 0.5 l)	Cat. No. LCZ 058
<u>Level controller</u> for thermostating an open external bath using pressure/suction pump	Cat. No. LPZ 901
<u>Non-return fitting</u> for automatic venting of the connecting hoses when thermostating an open external bath	Cat. No. UD 125
<u>Nipples</u> for pump connections 13 mm dia., 10 mm int. dia. 11 mm dia., 7 mm int. dia.	Cat. No. HKO 026 Cat. No. HKO 025
<u>Equipment trolley</u> for all compact bench thermostats RM 20-, RC-, RK- and RL-; movable; stepless height adjustment; cover plate of the units can be adjusted to height of laboratory bench.	Cat. No. LCZ 036

LAUDA Pt 100 platinum resistance thermometers
to DIN IEC 751 Class A for external control
and other temperature measurement

Pt 100-42

Pt 100-42

all-glass version with NS 14/23 ground taper DIN 12242
Temp. range -100...300°C
50% response time 0.8 sec
Overall length approx. 115 mm
4-wire circuit
Fig. 1

Cat. No. ETP 049

Pt 100-44

all-glass version with NS 14/23 ground taper DIN 12242
Temp. range -100...300°C
50% response time 0.8 sec
Overall length approx. 320 mm
Fig. 2

Cat. No. ETP 007

Pt 100-66

as Pt 100-44

Overall length approx. 430 mm
Fig. 2

Cat. No. ETP 008

Pt 100-90

stainless steel protection tube 4 mm dia.
Temp. range -100...300°C
50% response time 1.5 sec
Overall length approx. 120 mm
4-wire circuit
Fig. 3

Cat. No. ETP 050

Pt 100-70

stainless steel protection tube 4 mm dia.
Temp. range -200...300°C
50% response time 1.5 sec
Overall length approx. 290 mm
4-wire circuit
Fig. 3

Cat. No. ETP 009

Pt 100-92

stainless steel protection tube 4 mm dia.
with attached Silicone cable 2 m long and plug
Temp. range -100...200°C
50% response time 3 sec
Overall length approx. 250 mm
4-wire circuit
Fig. 4

Cat. No. ETP 051

Connecting cable

with 4-pin plug for external control on
all C-and K-units and for
digital thermometer for Pt 100-44 and
Pt 100-66 1.5 m
length as specified

Cat. No. UK 048

Cat. No. UK 213

Pt 100-42, Pt 100-70, Pt 100-90 1.5 m
length as specified

Cat. No. UK 047

Cat. No. UK 212

Screw clamp fitting

stainless steel, with Teflon pressure ring
for Pt 100 resistance thermometer 4 mm dia.
Fig 5

Cat. No. HX 078

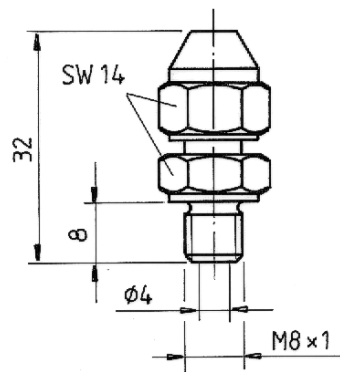
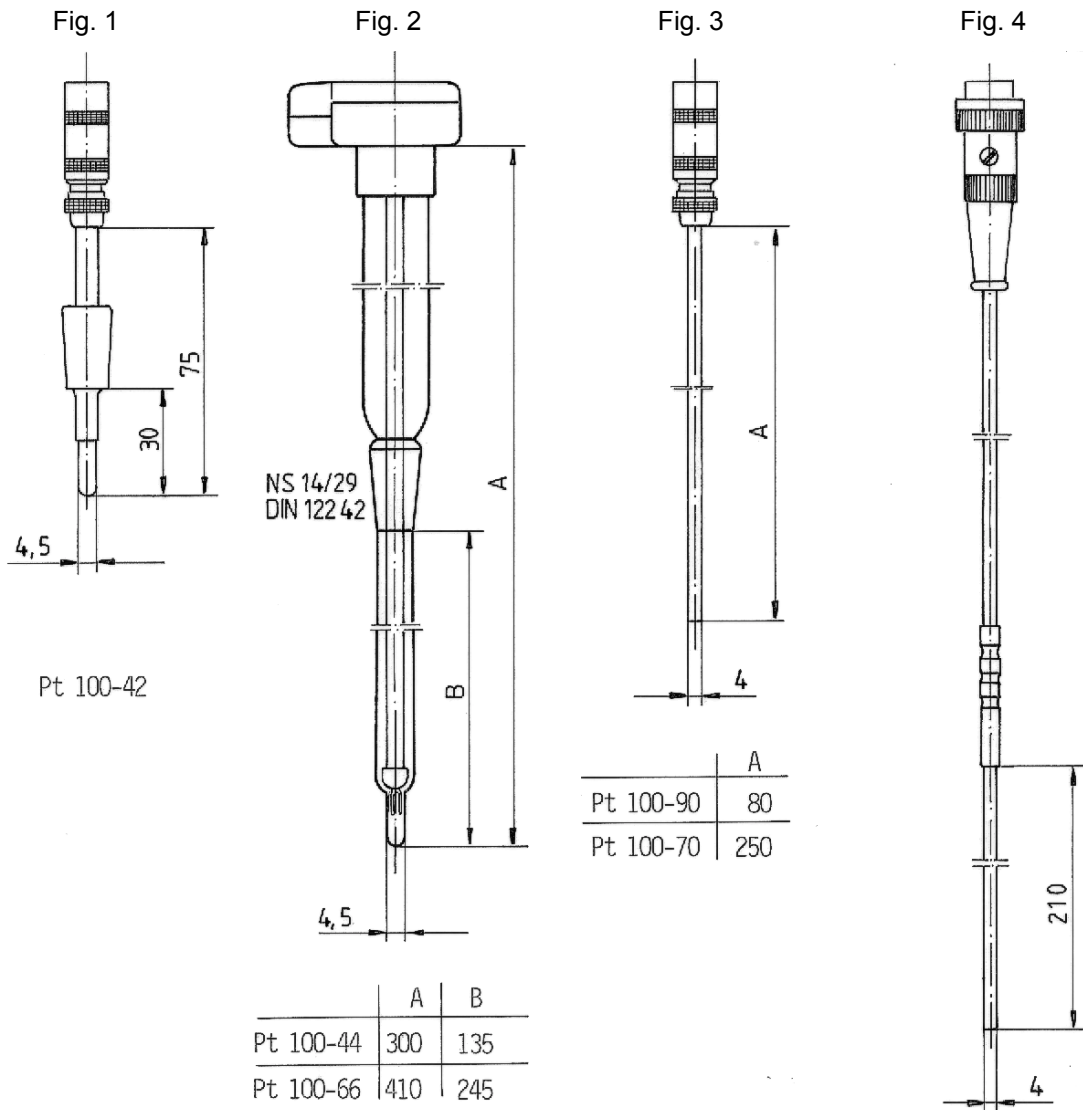

Geräteliste Schaltplan
List of parts Circuit diagram
Liste de schéma connexions
230V; 50Hz / 230V; 60Hz

RC 6 CS
RC 20 CS
RC 25 CS

gültig ab Serie V01
at serial no.
à partir

Teil-Nr. Part No. Pièce no.	Bezeichnung	Designation	Désignation	Best.-Nr. Ref.-No. No.Ref
A 1	Leiterplatte „Netz“	Printed circuit board „Mains“	Circuit imprimé „Secteur“	UL 429-3
A 2	Leiterplatte „Anzeige“	Printed circuit board „Indication“	Circuit imprimé „Affichage“	UL 430-2
B 1	Pt 100 Fühler Sicherheitskreis	Pt 100 Probe Safety circuit	Pt 100 Sonde Circuit sécurité	ETP 046
B 2	Pt 100 Fühler Regelung	Pt 100 Probe Controller	Pt 100 Sonde Réglage	ETP 046
B 3	Niveausensor	Level sensor	Niveau sensor	EKS 034
C 1	Motorkondensator	Motor condenser	Condensateur moteur	ECA 012
E 1	Heizkörper	Heater	Corps de chauffe	EH 162
F 1	Übertemperaturschutz (Umwälzpumpe)	Overtemperature protection (Circulating pump)	Protection de surpression (Pompe de circulation)	-----
F 2	Übertemperaturschutz Verdichter	Overtemperature protection compressor	Protection de surpression Compresseur	-----
F 3	Überdruckschalter	Overpressure switch	Disjoncteur de surpression	ES 035
M 1	Pumpenmotor	Pump motor	Moteur de pompe	EM 093
M 2	Verdichter	Compressor	Compresseur	EMV 001
M 3	Ventilator	Fan	Ventilateur	EML 011
R 1	Potentiometer Sollwert	Setpoint potentiometer	Potentiomètre valeur de consigne	UD 339
S 1	Netzschalter	Mains switch	Interrupteur secteur	EST 082
X 1	Netzanschluss / Netzkabel	Mains connection / Mains cable	Branchement secteur / Câble de secteur	EKN 008
X 2	Anschlussbuchse Rücklaufsicherung	Connection socket Reflow security valve	Douille de jonction Protection de refoulement	EQD 037+ EQZ 006

Geräteliste Schaltplan
List of parts Circuit diagram
Liste de schéma connexions
100V; 50Hz / 115V; 60Hz

RC 6 CS
RC 20 CS
RC 25 CS

gültig ab Serie V01
at serial no.
à partir

Teil-Nr. Part No. Pièce no.	Bezeichnung	Designation	Désignation	Best.-Nr. Ref.-No. No.Ref
A 1	Leiterplatte „Netz“	Printed circuit board „Mains“	Circuit imprimé „Secteur“	UL 429-3
A 2	Leiterplatte „Anzeige“	Printed circuit board „Indication“	Circuit imprimé „Affichage“	UL 430-2
B 1	Pt 100 Fühler Sicherheitskreis	Pt 100 Probe Safety circuit	Pt 100 Sonde Circuit sécurité	ETP 046 (US 060)
B 2	Pt 100 Fühler Regelung	Pt 100 Probe Controller	Pt 100 Sonde Réglage	ETP 046 (US 060)
B 3	Niveausensor	Level sensor	Niveau sensor	EKS 034
C 1	Motorkondensator	Motor condenser	Condensateur moteur	ECA 010
E 1	Heizkörper	Heater	Corps de chauffe	EH 153
F 1	Übertemperaturschutz (Umwälzpumpe)	Overtemperature protection (Circulating pump)	Protection de surpression (Pompe de circulation)	-----
F 2	Übertemperaturschutz Verdichter	Overtemperature protection compressor	Protection de surpression Compresseur	-----
F 3	Überdruckschalter	Overpressure switch	Disjoncteur de surpression	ES 035
M 1	Pumpenmotor	Pump motor	Moteur de pompe	EM 099
M 2	Verdichter	Compressor	Compresseur	EMV 001
M 3	Ventilator	Fan	Ventilateur	EML 011
R 1	Potentiometer Sollwert	Setpoint potentiometer	Potentiomètre valeur de consigne	UD 339
S 1	Netzschalter	Mains switch	Interrupteur secteur	EST 085
X 1	Netzanschluss / Netzkabel	Mains connection / Mains cable	Branchement secteur / Câble de secteur	EKN 007
X 2	Anschlussbuchse Rücklaufsicherung	Connection socket Reflow security valve	Douille de jonction Protection de refoulement	EQD 037+ EQZ 006

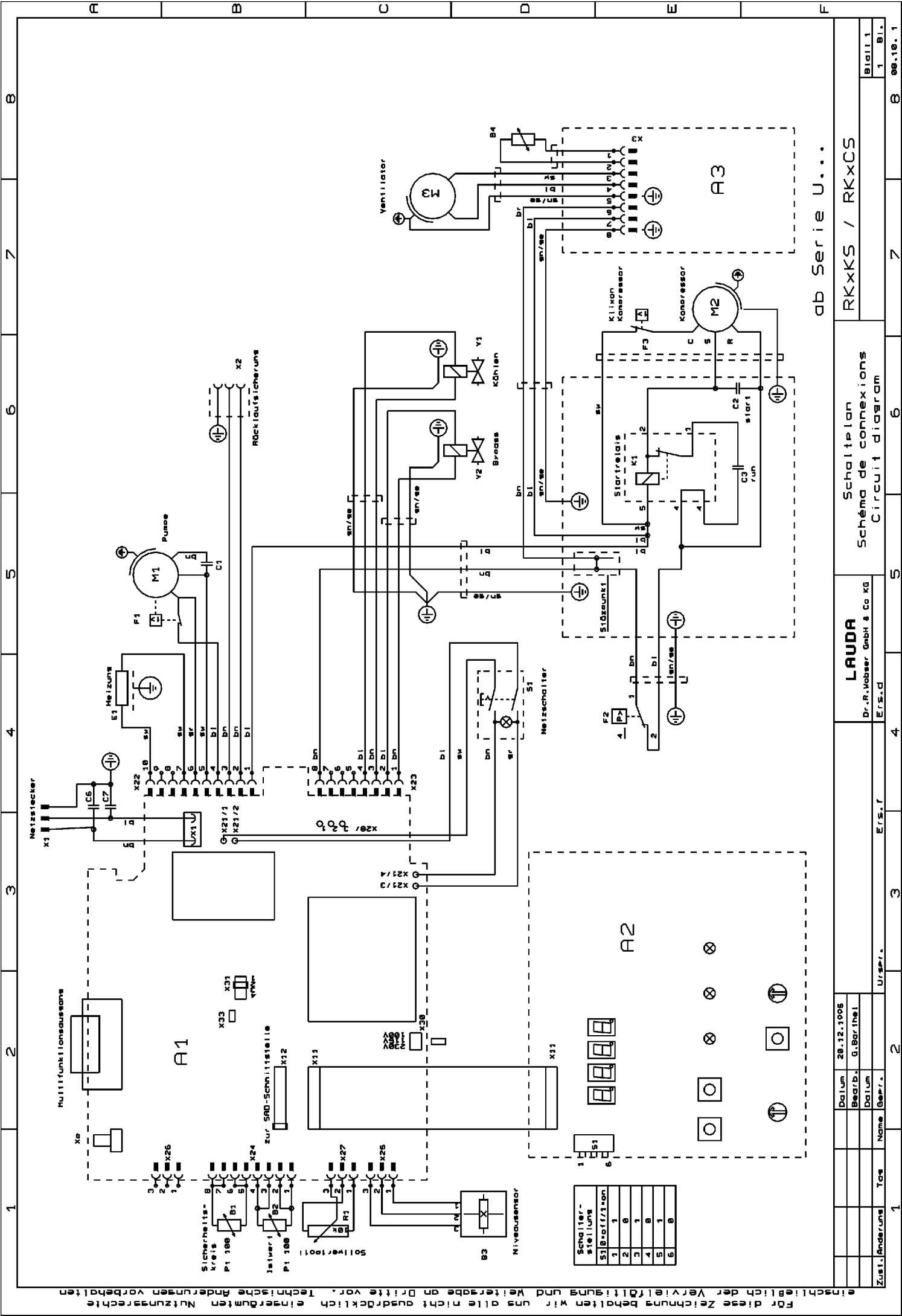

Für diese Zeichnung behalten wir uns alle nicht ausdrücklich eingeräumten Nutzungsrechte einschließlich der Vervielfältigung und Weitergabe an Dritte vor. Technische Änderungen vorbehalten

ab Serie U...

Schaltplan
Schéma de connexions
Circuit diagram

LAUDA
Dr. R. Wobser GmbH & Co. KG
E.R.S.D

RKxKS / RKxCS

Zust./Änderung	Tag	Name	Gepr.	Urspr.

Blatt 1
1 Bl. 1
09.10.1

Geräteliste Schaltplan
List of parts Circuit diagram
Liste de schéma connexions
230V; 50Hz / 230V; 60Hz

RK 8 KS
RK 20 KS
RK 8 CS

gültig ab Serie V01
at serial no.
à partir

Teil-Nr. Part No. Pièce no.	Bezeichnung	Designation	Désignation	Best.-Nr. Ref.-No. No.Ref	Best.-Nr. Ref.-No. No.Ref
				RK 8 KS RK 20 KS	RK 8 CS
A 1	Leiterplatte „Netz“	Printed circuit board „Mains“	Circuit imprimé „Secteur“	UL 432-3	UL 432-3
A 2	Leiterplatte „Anzeige“	Printed circuit board „Indication“	Circuit imprimé „Affichage“	UL 430-2	UL 430-2
A 3	Leiterplatte „Drehzalregelung Lüftermotor“	Printed circuit board „Speed control ventilator motor“	Circuit imprimé „Régulation de vitesse moteur de ventilateur“	UL 473 (UD 349)	UL 473 (UD 349)
B 1	Pt 100 Fühler Sicherheitskreis	Pt 100 Probe Safety circuit	Pt 100 Sonde Circuit sécurité	ETP 046	ETP 046
B 2	Pt 100 Fühler Regelung	Pt 100 Probe Controller	Pt 100 Sonde Réglage	ETP 046	ETP 046
B 3	Niveausensor	Level sensor	Niveau sensor	EKS 034	EKS 034
B 4	Fühler Drehzahlregelung	Probe Speed control	Sonde régulation de vitesse	US 041	US 041
C 1	Motorkondensator	Motor condenser	Condensateur moteur	ECA 007	ECA 007
E 1	Heizkörper	Heater	Corps de chauffe	EH 149	EH 149
F 1	Übertemperaturschutz (Umwälzpumpe)	Overtemperature protection (Circulating pump)	Protection de surpression (Pompe de circulation)	-----	-----
F 2	Übertemperaturschutz Verdichter Stufe 1	Overtemperature protection compressor stage 1	Protection de surpression Compresseur étage 1	-----	-----
F 3	Überdruckschalter	Overpressure switch	Disjoncteur de surpression	ES 035	ES 035
K 1	Anlaufrelais	Starting relay	Relais de démarrage	-----	-----
M 1	Pumpenmotor	Pump motor	Moteur de pompe	EM 094	EM 094
M 2	Verdichter	Compressor	Compresseur	-----	-----
M 3	Ventilator	Fan	Ventilateur	-----	-----
R 1	Potentiometer Sollwert	Setpoint potentiometer	Potentiomètre valeur de consigne	UD 339	UD 339
S 1	Netzschalter	Mains switch	Interrupteur secteur	EST 032	EST 082
X 1	Netzanschluss / Netzkabel	Mains connection / Mains cable	Branchement secteur / Câble de secteur	EKN 008	EKN 008
X 2	Anschlussbuchse Rücklaufsicherung	Connection socket Reflow security valve	Douille de jonction Protection de refoulement	EQD 037+ EQZ 006	EQD 037+ EQZ 006

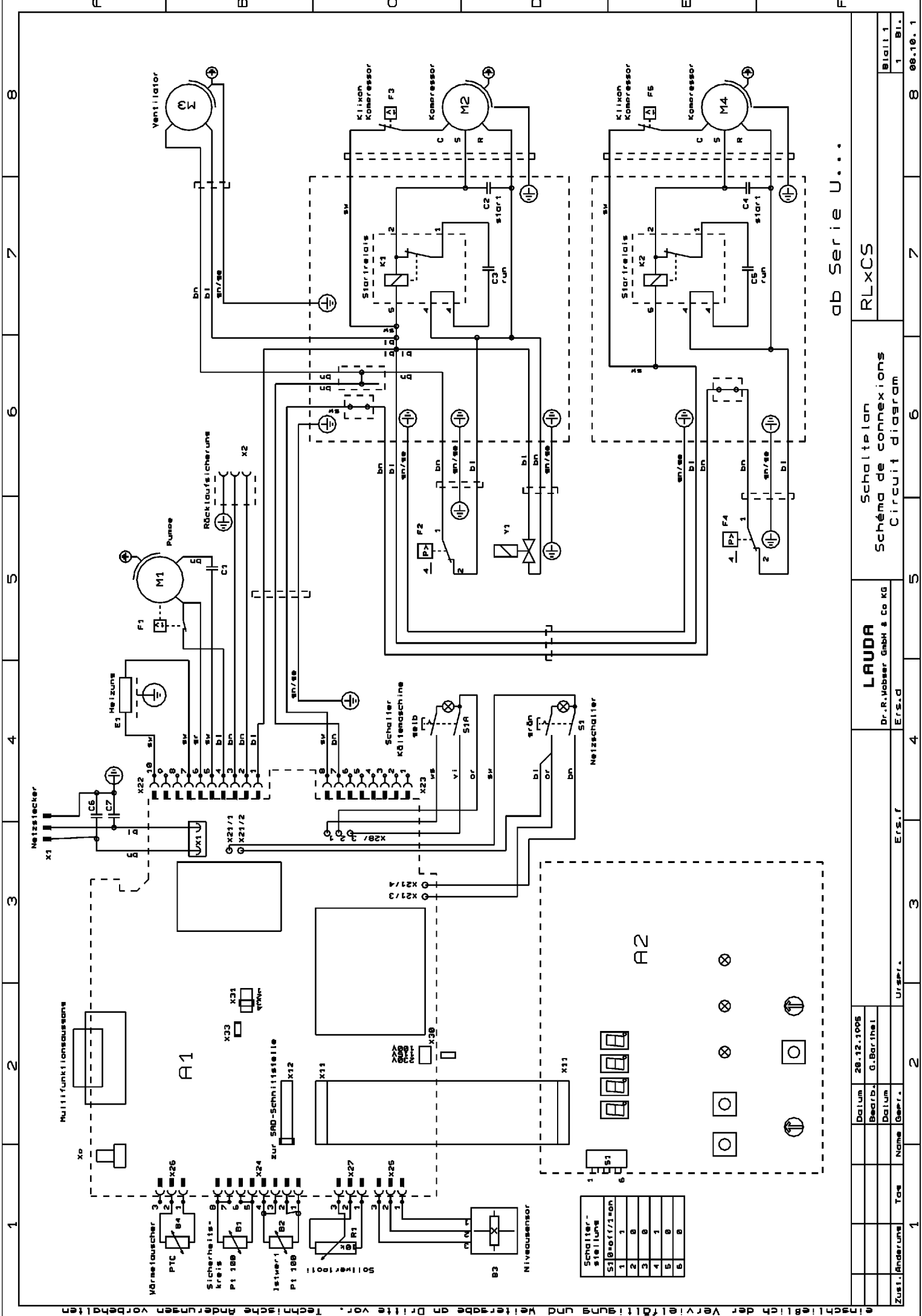

Datum		28.12.1995	Urspr.		3	Ers.f		4	Ers.d		5	Schaltplan		6	Schema de connexions		7	Circuit diagram		8	ab Serie U...		8	08.10.1	
Beauf.		G.Barthel	Name			Ers.f			Ers.d			Dr.-R. Weber GmbH & Co KG			Dr.-R. Weber GmbH & Co KG			Dr.-R. Weber GmbH & Co KG			Dr.-R. Weber GmbH & Co KG			Dr.-R. Weber GmbH & Co KG	
Zust.			Name			Ers.f			Ers.d			Dr.-R. Weber GmbH & Co KG			Dr.-R. Weber GmbH & Co KG			Dr.-R. Weber GmbH & Co KG			Dr.-R. Weber GmbH & Co KG			Dr.-R. Weber GmbH & Co KG	
Zust.			Name			Ers.f			Ers.d			Dr.-R. Weber GmbH & Co KG			Dr.-R. Weber GmbH & Co KG			Dr.-R. Weber GmbH & Co KG			Dr.-R. Weber GmbH & Co KG			Dr.-R. Weber GmbH & Co KG	

RLXCS

Schaltplan
Schema de connexions
Circuit diagram

LAUDA

Dr.-R. Weber GmbH & Co KG
Ers.d

Urspr.

Datum
Beauf.

Zust.
Name
Ers.f
Ers.d

Geräteliste Schaltplan
List of parts Circuit diagram
Liste de schéma connexions
230V; 50Hz / 230V; 60Hz

RL 6 CS
RL 7 CS

gültig ab Serie A01
at serial no.
à partir

Teil-Nr. Part No. Pièce no.	Bezeichnung	Designation	Désignation	Bestell-Nr. Ref.-No. No.Ref
A 1	Leiterplatte „Netz“	Printed circuit board „Mains“	Circuit imprimé „Secteur“	UL 432-3
A 2	Leiterplatte „Anzeige“	Printed circuit board „Indication“	Circuit imprimé „Affichage“	UL 430-2
B 1	Pt 100 Fühler Sicherheitskreis	Pt 100 Probe Safety circuit	Pt 100 Sonde Circuit sécurité	ETP 047
B 2	Pt 100 Fühler Regelung	Pt 100 Probe Controller	Pt 100 Sonde Réglage	ETP 047
B 3	Niveausensor	Level sensor	Niveau sensor	EKS 034
B 4	Fühler KTY 81	Probe KTY 81	Sonde KTY 81	ETP 027
C 1	Motorkondensator	Motor condenser	Condensateur moteur	ECA 012
E 1	Heizkörper	Heater	Corps de chauffe	EH 163
E 3	Heizband	Heater band	Ruban de chauffe	UD 387
F 1	Übertemperaturschutz (Umwälzpumpe)	Overtemperature protection (Circulating pump)	Protection de surpression (Pompe de circulation)	-----
F 2	Überdruckschalter Stufe 1	Overpressure switch stage 1	Disjoncteur de surpression étage 1	ES 048
F 3	Übertemperaturschutz Verdichter Stufe 1	Overtemperature protection compressor stage 1	Protection de surpression Compresseur étage 1	-----
F 4	Überdruckschalter Stufe 2	Overpressure switch stage 2	Disjoncteur de surpression étage 2	ES 048
F 5	Übertemperaturschutz Verdichter Stufe 2	Overtemperature protection Compressor stage 2	Protection de surpression Compresseur étage 2	-----
K 11	Anlaufrelais (M 2)	Starting relay (M 2)	Relais de démarrage (M 2)	-----
M 1	Pumpenmotor	Pump motor	Moteur de pompe	EM 062
M 2	Verdichter Stufe 1	Compressor stage 1	Compresseur étage 1	-----
M 3	Ventilator	Fan	Ventilateur	-----
M 4	Verdichter Stufe 2	Compressor stage 2	Compresseur étage 2	-----
R 1	Potentiometer Sollwert	Setpoint potentiometer	Potentiomètre valeur de consigne	UD 339
S 1	Netzschalter	Mains switch	Interrupteur secteur	EST 082
X 1	Netzanschluss / Netzkabel	Mains connection / Mains cable	Branchement secteur / Câble de secteur	EKN 008
X 2	Anschlussbuchse Rücklaufsicherung	Connection socket Reflow security valve	Douille de jonction Protection de refoulement	EQD 037 + EQZ 006

An / To / A:

LAUDA Dr. R. Wobser • LAUDA Service Center • Fax: +49 (0) 9343 - 503-222

Von / From / De :

Firma / Company / Entreprise: _____

Straße / Street / Rue: _____

Ort / City / Ville: _____

Tel.: _____

Fax: _____

Betreiber / Responsible person / Personne responsable: _____

Hiermit bestätigen wir, daß nachfolgend aufgeführtes LAUDA-Gerät (Daten vom Typenschild):

We herewith confirm that the following LAUDA-equipment (see label):

Par la présente nous confirmons que l'appareil LAUDA (voir plaque signalétique):

Typ / Type / Type :	Serien-Nr. / Serial no. / No. de série:

mit folgendem Medium betrieben wurde

was used with the below mentioned media

a été utilisé avec le liquide suivant

Darüber hinaus bestätigen wir, daß das oben aufgeführte Gerät sorgfältig gereinigt wurde, die Anschlüsse verschlossen sind, und sich weder giftige, aggressive, radioaktive noch andere gefährliche Medien in dem Gerät befinden.

Additionally we confirm that the above mentioned equipment has been cleaned, that all connectors are closed and that there are no poisonous, aggressive, radioactive or other dangerous media inside the equipment.

D'autre part, nous confirmons que l'appareil mentionné ci-dessus a été nettoyé correctement, que les tubulures sont fermées et qu'il n'y a aucun produit toxique, agressif, radioactif ou autre produit nocif ou dangereux dans la cuve.

Stempel Seal / Cachet.	Datum Date / Date	Betreiber Responsible person / Personne responsable

Formblatt / Form / Formulaire:

Unbedenk.doc

Erstellt / published / établi:

LSC

Änd.-Stand / config-level / Version:

0.1

Datum / date:

30.10.1998

LAUDA DR. R. WOBSE GmbH & Co. KG

Pfarrstraße 41/43

D - 97922 Lauda-Königshofen

Internet: <http://www.lauda.de>

Tel: +49 (0)9343 / 503-0

Fax: +49 (0)9343 / 503-222

E-mail: info@lauda.de