

T3DSO1000 Digital Oscilloscope Quick Start Guide

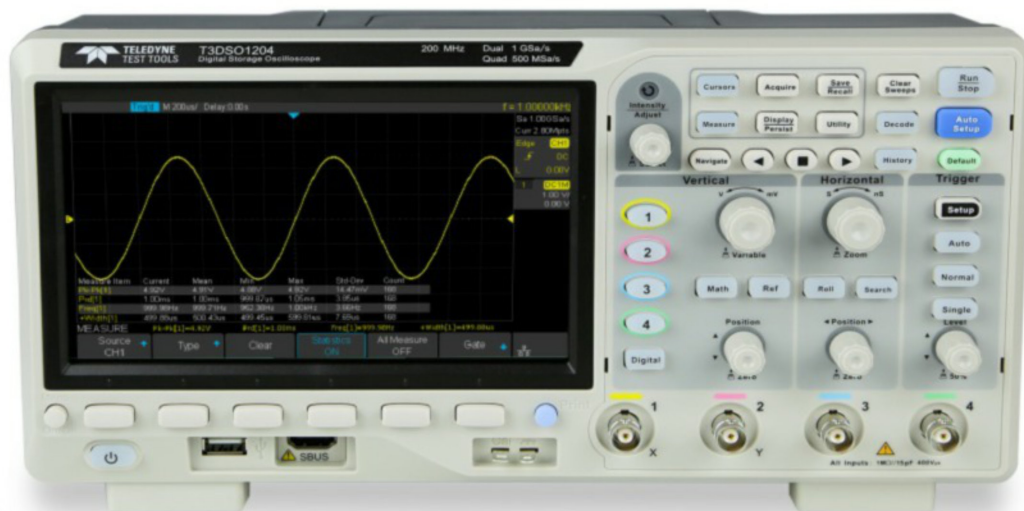

Contents

General Safety Summary	1
Daily Maintenance and Cleaning	3
General Inspection	4
Size and Adjustments	5
Connecting to AC Power	6
Connecting and Compensating Probes	6
Front and Rear Panels	8
Front Panel Operation	10
Display Overview	18
Troubleshooting	20

© 2018 Teledyne LeCroy, Inc. All rights reserved.

Teledyne Test Tools is a brand and trademark of Teledyne LeCroy, Inc. Other product or brand names are trademarks or requested trademarks of their respective holders. Specifications, prices, availability and delivery subject to change without notice.

General Safety Summary

Read the following precautions carefully to avoid any personal injuries, or damage to the instrument or products connected to it. Use the instrument only as specified.

Use only the power cord supplied for the instrument.

Ground the instrument. The instrument is grounded through the ground conductor of the power cord. To avoid electric shock, always connect to grounded outlets. Make sure the instrument is grounded correctly before connecting its input or output terminals.

Connect the signal wire correctly. To avoid damage, observe input polarity and maximum voltage/current ratings at all times.

Observe all terminal ratings and signs on the instrument to avoid fire or electric shock. Before connecting to the instrument, read the manual to understand the input/output ratings.

Do not operate with suspected failures. If you suspect that the instrument is damaged, contact the Teledyne LeCroy service department immediately.

Do not operate in wet/damp conditions.

Do not operate in an explosive atmosphere.

Keep the surface of the instrument clean and dry.

Avoid touching exposed circuits or wires. Do not touch exposed contacts or components when the power is on.

Do not operate without covers. Do not operate the instrument with covers or panels removed.

Use only the fuse specified for the instrument.

Use proper over voltage protection.

Use anti-static protection. Operate in an anti-static protected area. Ground measurement cable conductors before connecting to the instrument to discharge any static electricity before connecting the cables to the instrument.

Observe ventilation requirements. Ensure good ventilation. Check the vent and fan regularly to prevent overheating.

Safety Terms and Symbols

The following terms may appear on the instrument:

DANGER: Direct injury or hazard may occur.

WARNING: Potential injury or hazard may occur.

CAUTION: Potential damage to instrument/property may occur.

The following symbols may appear on the instrument:



CAUTION
Risk of injury or damage. Refer to manual.



WARNING
Risk of electric shock or burn



Earth Ground Terminal



Protective Conductor Terminal



Frame or Chassis Terminal



ON/Standby Power



Alternating Current

Measuring Terminal Ratings

Max. Input Voltage: $1\text{ M}\Omega \leq 400\text{ Vpk}$ (DC + Peak AC $\leq 10\text{ KHz}$)

Derated Voltage: 400 Vmax to 10 KHz, derating at 20 dB/decade to 10 Vmax at 400 KHz

No rated measurement category (CAT) per IEC/EN 61010-031:2015. Measuring terminals on this product are not intended to be connected directly to mains.

Operating Environment

Temperature: 10 °C to 40 °C

Relative Humidity: 85% RH at 40 °C for up to 24 hours

Altitude: $\leq 3000\text{ m}$

Use indoors only.

Pollution Degree 2. Use in an operating environment where normally only dry, non-conductive pollution occurs. Temporary conductivity caused by condensation should be expected.

AC Power

Input Voltage & Frequency: 100-120 V at 400 Hz or
100-240 V at 50/60 Hz

Automatic AC selection.

Power Consumption: 50 W maximum

Mains Supply Connector: CAT II per IEC/EN 61010-1:2010,
instrument intended to be supplied from the building wiring at
utilization points (socket outlets and similar).

Fuse Type

1.25 A / 250 V "T" rated 5x20 mm

Daily Maintenance and Cleaning

Maintenance

Protect the liquid crystal display from direct sunlight when storing or using the instrument.

NOTE:

To avoid damage to the instrument or test leads, do not place them in mist, liquid or solvent.

Cleaning

Regularly clean the instrument and test leads.

- Wipe the external dust off the instrument and test leads using a damp soft rag. Be careful not to scratch the display screen when cleaning. Do not allow any liquid to enter the instrument.
- Use a 75% isopropyl alcohol/water solution when a more thorough cleaning is necessary.

NOTE:

To prevent damage to the surface of the instrument or test leads, do not use any corrosive or chemical cleaning agents. Make sure the instrument is fully dry before reconnecting the power to avoid short circuiting or personal injury.

General Inspection

Please check the instrument according to the following steps.

1. Inspect the shipping container.

Keep the shipping container and packaging material until the contents of the shipment have been completely checked and the instrument has passed both electrical and mechanical tests. It is always good practice to save the shipping container and packaging for use when returning the power supply to Teledyne LeCroy for service or calibration.

The consigner or carrier will be responsible for damage to the instrument resulting from shipping. Teledyne LeCroy will not provide free maintenance or replacement in this instance.

2. Inspect the instrument.

If the instrument is found to be damaged, defective or fails in electrical or mechanical tests, please contact the Teledyne LeCroy service department immediately.

3. Check the accessories.

Please check that you have received the accessories on the packing list. If the accessories are incomplete or damaged, please contact Teledyne LeCroy immediately.

Size and Adjustments

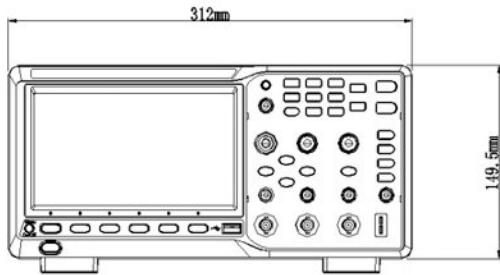

T3DSO1102 Front View

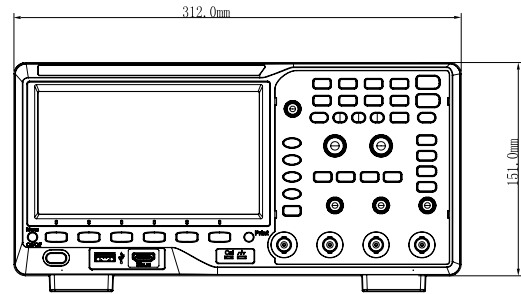

T3DSO1104 / T3DSO1202A / T3DSO1204 / T3DSO1302A Front View

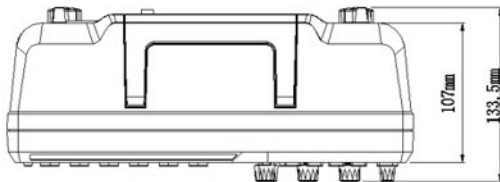

T3DSO1102 Top View

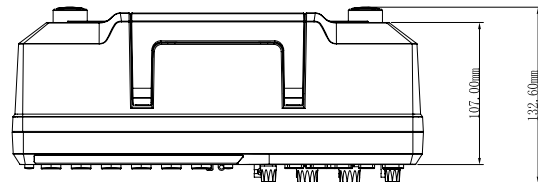

T3DSO1104 / T3DSO1202A / T3DSO1204 / T3DSO1302A Top View

Adjusting the Supporting Legs

Adjust the supporting legs to adjust the angle / tilt of the oscilloscope for best ease of use. The oscilloscope is stable in flat or tilted mode. The oscilloscope is not stable if one supporting leg is extended and the other is not. Both supporting legs should either be extended or not.

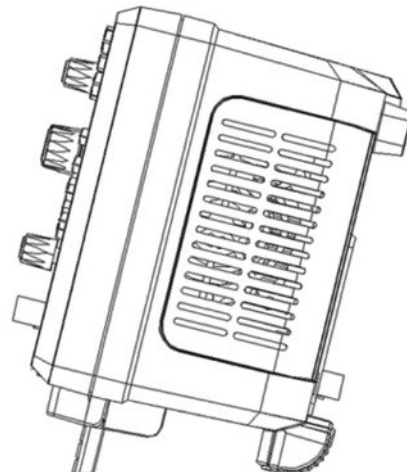
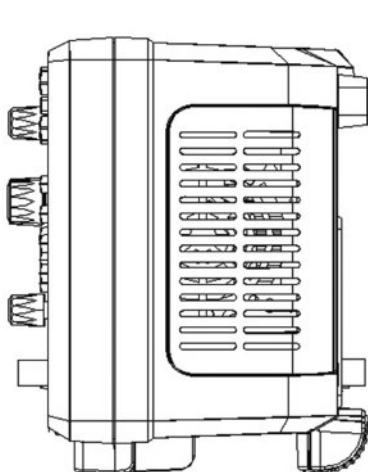

Connecting to AC Power

The oscilloscope accepts 100-240 V, 50/60/440 Hz AC power. Use only the power cord provided to connect the instrument to the power source, as shown in the figure below.

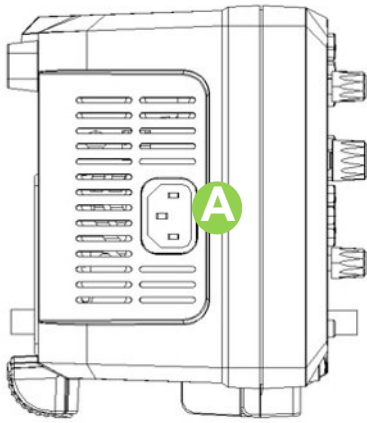

T3DSO1102

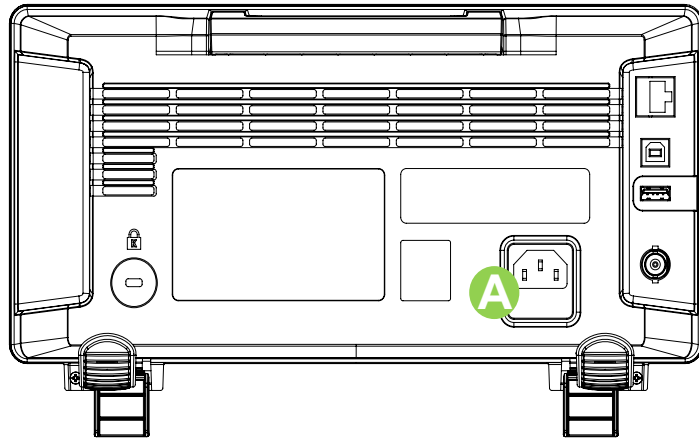

T3DSO1104 / T3DSO1204 / T3DSO1202A / T3DSO1302A

A Connect the power cord to socket A in the diagram above.

Note: If at any time the fuse requires replacement, please replace it only with a fuse of the same rating as the original. If there are questions, please contact Teledyne LeCroy service directly.

Power-on Inspection

Turn on the power switch at the lower left corner on the front panel. During the start-up process, the instrument performs a series of self-tests and the user can hear the sound of relays switching. The User Interface displays immediately after the self-test is complete.



Connecting and Compensating Probes

The Teledyne Test Tools oscilloscope is provided with one passive probe for for each channel (excluding Ext Trigger). Please refer to corresponding Probe User Manual for detailed probe technical information.

Connecting Probes

1. Connect the BNC terminal of the probe to one of the channel BNC connectors on the front panel.
2. Connect the probe tip to the circuit point to test and the ground alligator clip of the probe to the ground terminal of the circuit.

Functional Inspection

1. Press  to reset the oscilloscope to its factory default setup.
2. Connect the probe to CH1. Connect the ground alligator clip of the probe to the Ground Terminal on the front panel.
3. Connect the probe tip to the Compensation Signal Output Terminal on the front panel.
4. Press .
5. Observe the waveform on the screen. The display should be a square waveform as shown in the screen image below.
6. Test the other channels using the same method. The displayed square waveform should be a square wave as in the screen image below. If the displayed signal does not match the screen image below, then please perform a "Probe Compensation".

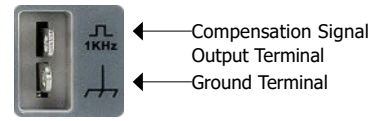

▲ T3DSO1102

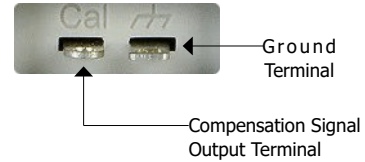

▲ T3DSO1104 / T3DSO1202A /
T3DSO1204 / T3DSO1302A

Note: Please make certain that the insulated wire of the probe is in good condition to avoid electric shock when using the probes, and do not touch the metallic part of the probe when it is connected to a high voltage.

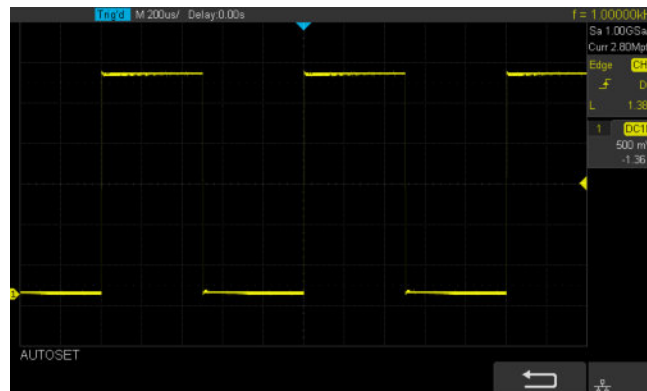

Probe Compensation

The oscilloscope requires proper compensation adjustment to give accurate results. Non-compensated or inadequately compensated probes may give inaccurate measurements. Follow the steps below to adjust the probe compensation:

1. Check the displayed waveforms and compare them with the diagrams below.
2. Use a non-metallic screwdriver to adjust the low-frequency compensation adjustment hole on the probe until the waveform changes to be correctly compensated as in the centre figure below and the screen image above.

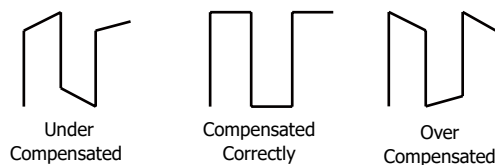

Front Panel - T3DSO1102 Oscilloscope

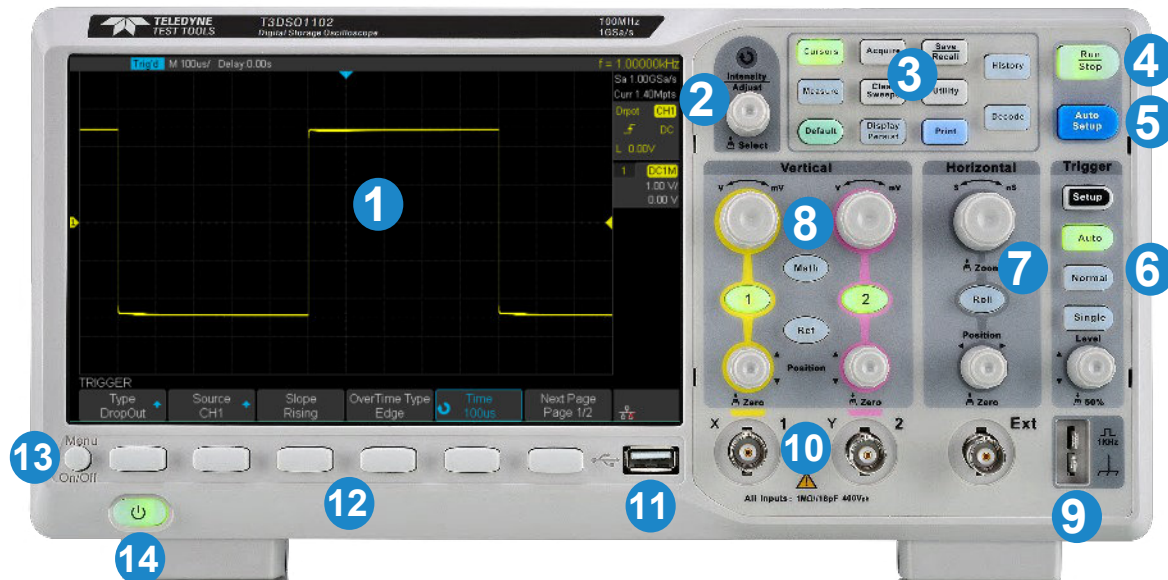

1. Waveform Display and User Interface
2. Universal Knob
3. Common Function Menus
4. Run/Stop Button
5. Auto Setup Button
6. Trigger Controls
7. Horizontal Controls

8. Channel Vertical Controls, Math and Ref
9. Probe Compensation
10. Analog Channel Inputs
11. USB Host Port
12. Function Menu Softkeys
13. Menu On/Off Button
14. Power On/Off Button

Rear Panel - T3DSO1102 Oscilloscope

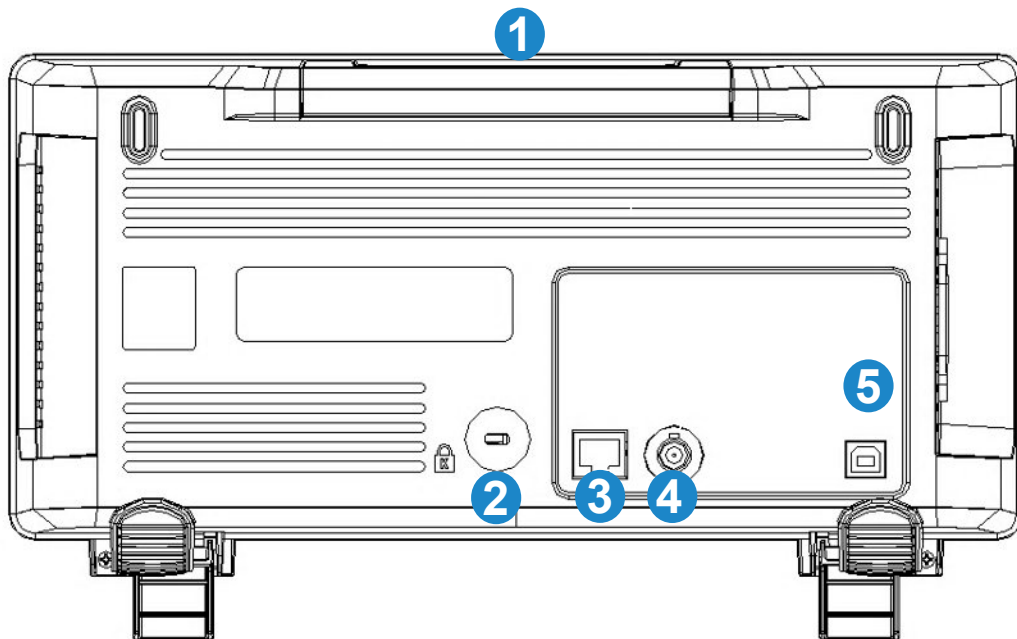

1. Handle

2. Safety Lock Hole

This is a Kensington Lock point to secure your oscilloscope. The Kensington Lock is not supplied with the oscilloscope.

3. LAN Interface

The instrument can be connected to the network via a LAN cable.

4. Pass/Fail or Trig Out Output

The connector can be configured to output a pulse when the oscilloscope triggers or output a pulse on a Pass/Fail condition.

5. USBTMC Device

The Teledyne Test Tools T3DSO1000 series oscilloscopes support SCPI remote control commands. User can control the oscilloscope through this interface

Front Panel - T3DSO1104 / T3DSO1202A / T3DSO1204 / T3DSO1302A Oscilloscopes

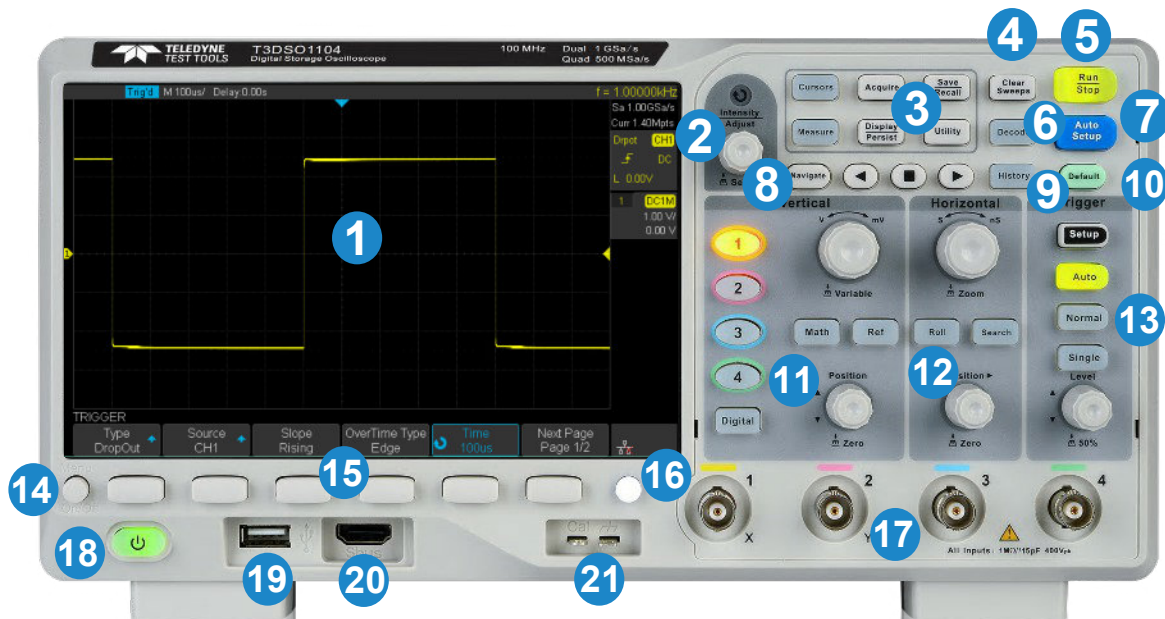

- | | |
|--|---|
| <ol style="list-style-type: none"> 1. Waveform Display and User Interface 2. Universal Knob 3. Common Function Menus 4. Clear Sweeps 5. Run/Stop 6. Serial Bus Decode 7. Auto Setup 8. Navigate 9. History 10. Default Setup | <ol style="list-style-type: none"> 11. Channel Vertical Control, Math, Reference and Digital 12. Horizontal Controls 13. Triggering Controls 14. Menu On/Off 15. Menu Softkeys 16. One Button Shortcut to Print/Save 17. Analog Channel Inputs 18. Power On/Off 19. USB Host Port 20. SBUS Digital Inputs 21. Probe Compensation |
|--|---|

WARNING: Item 20 is not an HDMI interface. It is for the Teledyne Test Tools digital channels ONLY. Do not connect other devices or you may damage your oscilloscope.

Note: T3DSO1104 and T3DSO1204 do not have an EXT external trigger input.

Note: T3DSO1202A and T3DSO1302A input channels (item 17 above) comprises of two analog channels and an EXT external trigger input.

Rear Panel - T3DSO1104 / T3DSO1202A / T3DSO1204 / T3DSO1302A Oscilloscopes

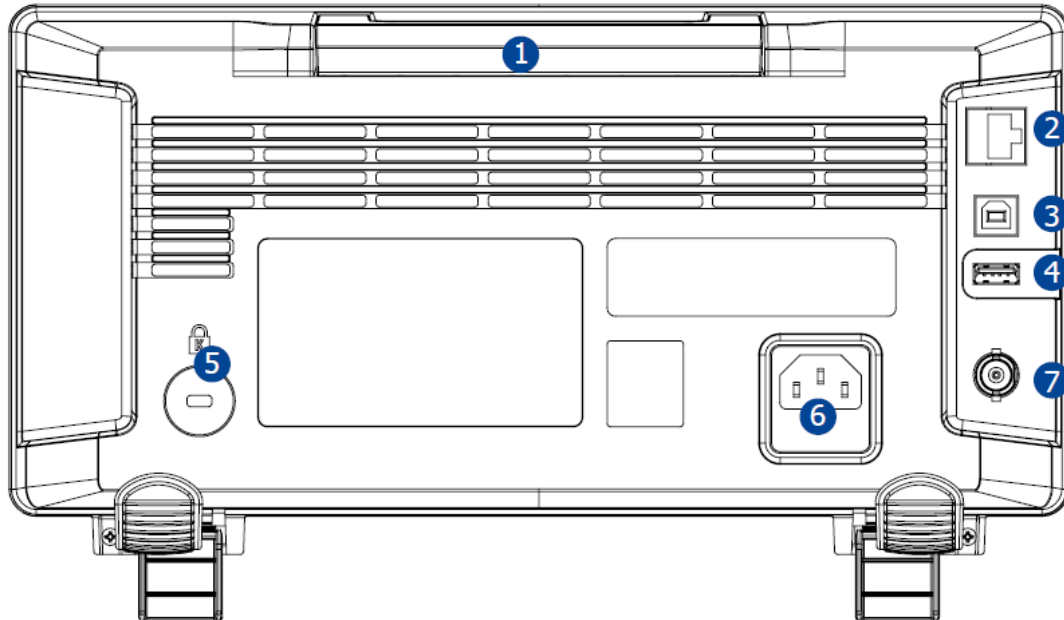

1. Handle

2. LAN Interface

The instrument can be connected to the network via a LAN cable.

3. USBTMC Device

The Teledyne Test Tools T3DSO1000 series oscilloscopes support SCPI remote control commands. User can control the oscilloscope through this interface

4. USB Host

5. Safety Lock Hole

This is a Kensington Lock point to secure your oscilloscope. The Kensington Lock is not supplied with the oscilloscope.

6. AC Power Socket

The power requirements of this oscilloscope are 100-240 V, 50/60/400 Hz. Use the power cord provided with the instrument to connect it to AC power.

7. Pass/Fail or Trig Out Output

The connector can be configured to output a pulse when the oscilloscope triggers or output a pulse on a Pass/Fail condition.

Front Panel Operation

Horizontal Control



Quickly enter into Roll mode. Roll mode gives screen updates similar to that of a strip chart recorder, and is primarily used for low frequency signals. The timebase range for Roll mode is from 50 ms/div to 100 s/div.

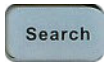

Enable or disable the search function. This function can search for the events that users specify in the acquired data, the results are displayed with white triangle symbol.



T3DSO1104 /
T3DSO1202A /
T3DSO1204 /
T3DSO1302A



T3DSO1102



Horizontal Position: Adjusts the horizontal time location on the display. Zero time is the trigger point. The waveform will move left or right when the knob is turned. The Delay value will increase or decrease as the waveform moves. Press the knob to reset the trigger delay to zero.



Horizontal Time Base: The timebase is adjusted by turning the knob clockwise or anti-clockwise to increase or decrease the time window being captured on the oscilloscope. The waveform will be expanded or compressed when the timebase is adjusted. Press the knob to enter into Zoom mode.

Trigger Adjustment



Press the Setup button to open trigger menu. The oscilloscope provides various trigger types: Edge, Slope, Pulse, Video, Window, Interval, DropOut, Runt, Pattern and Serial Bus (IIC / SPI / UART / RS232 / CAN / LIN)

Following is an introduction to Video, Interval, Runt, Pattern and Serial Bus trigger.

HDTV Video Trigger

The T3DSO1000 supports analog video signal (NTSC / PAL) trigger and HDTV signal trigger. In video trigger, you can select custom to set any line and field

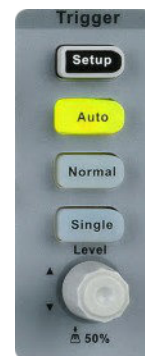

T3DSO1104 /
T3DSO1202A /
T3DSO1204 /
T3DSO1302A



T3DSO1102

Interval Trigger

The time interval from the rising edge (or falling edge) of input signal passes through the trigger level to the next rising edge(or falling edge) passes through the trigger level and the currently set time satisfy the Limit Range ($< =$, $> =$, [--.--], --] [--] selected.

In the figure below, the time interval between two continuous rising edge and the currently set time satisfy the limit range ([--.--])

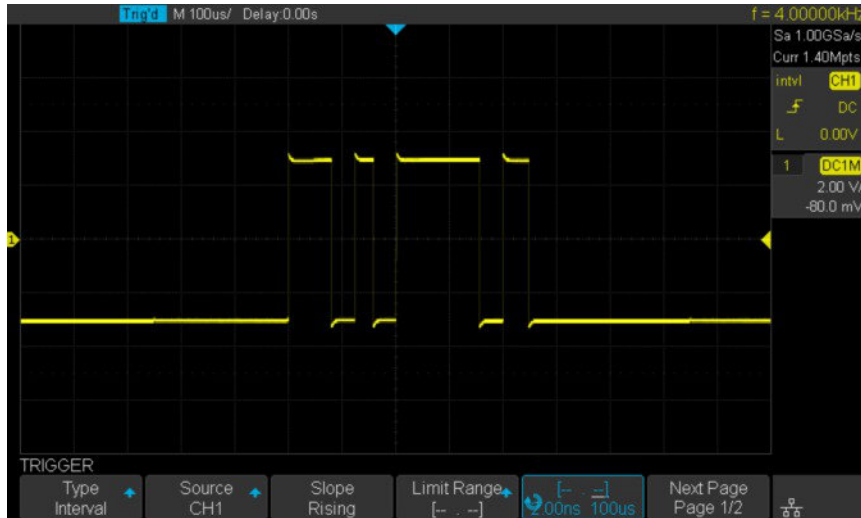

Runt Trigger

Runt trigger includes positive runt trigger and negative runt trigger. This mode is used to trigger pulses that pass through one trigger level but fails to pass through the other trigger level as shown in the figure below.

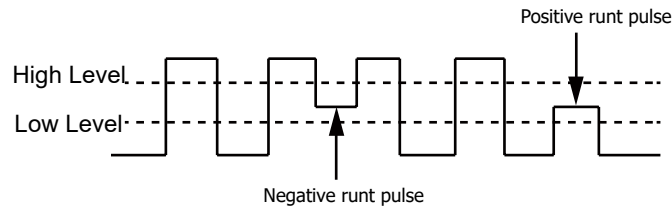

In the figure below, the trigger signal is a positive runt pulse.

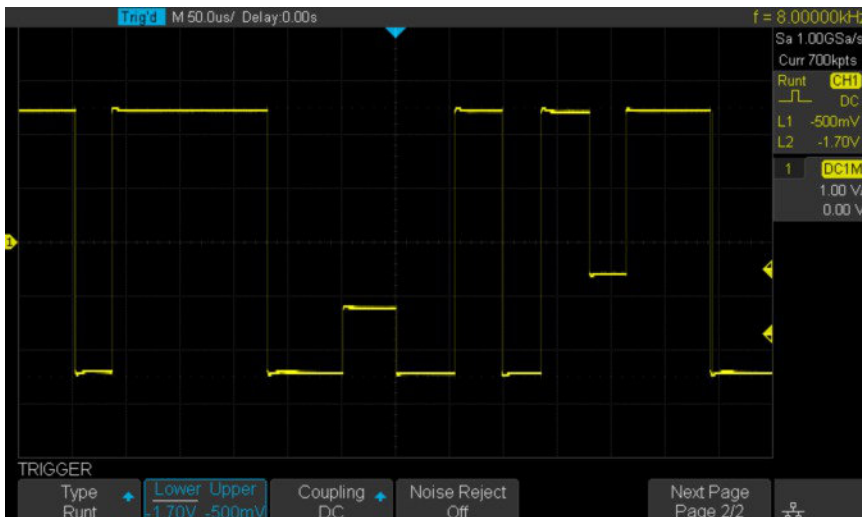

Pattern Trigger

Identify a trigger condition by looking for a specified pattern. This pattern is a logical combination (AND / OR / NAND / NOR) of the channels. Each channel can be set a value among High, Low or Invalid.

In the figure below, the selected logic is "NAND", channel 1 is set to "Low", channel 2 is set to "High".



I2C Trigger

Set the serial 1 or 2 to IIC type in trigger menu. Use universal knob to set to trigger on a start/stop condition, restart, no ack, EEPROM, or on the read / write frame with specific device address and data value. During IIC trigger settings, it is essential to set source channel previously in decode menu.

In the figure below, the trigger condition is set to "Start", channel 1 is set as Clock signal, channel 2 is set as Data signal.

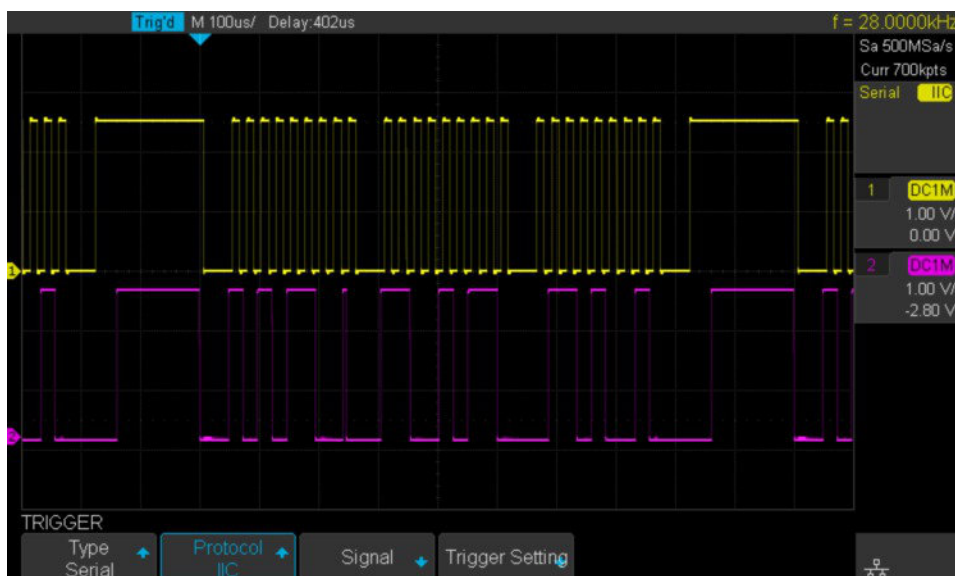

SPI Trigger

After setting the serial trigger to SPI type in trigger menu, you can select to trigger on MISO data or MOSI data. The data length are variable to set from 4 to 96.

UART/RS232 Trigger

After setting the serial trigger to UART/RS232 type in trigger menu, you can select to trigger on start , stop, checksum error or data. The data width are variable to set from 5 to 8bits.

CAN Trigger

After setting the serial trigger to CAN type in trigger menu, you can select to trigger on start, remote, ID, ID+DATA or Error of CAN-H or CAN-L signal.

LIN Trigger

After setting the serial trigger to LIN type in trigger menu, you can select to trigger on Start, ID, ID+DATA or Data Error.

 Press the button to set to Auto trigger mode.

 Press the button to set to Normal trigger mode.

 Press the button to set to Single trigger mode.



Use the Trigger Level knob to set the trigger level. Turn the knob clockwise or anticlockwise to change the level up or down. The trigger level value is displayed at the upper right of the screen and will increase or decrease accordingly. Press the knob to quickly reset the trigger level to the 50% level of the trigger channel waveform.

Vertical Control

The two / four channels are marked by different colors which are also used to mark the waveforms on the screen and the channel input connectors. Press the channel button to open the corresponding channel and press again to turn it off.



Vertical Position Sets the vertical offset / position of the current waveform. Turn clockwise or anticlockwise to adjust the offset / waveform position.

During the adjustment, the waveform will move up and down and the offset message at the lower part of the screen will change. Press the knob to quickly reset the offset to zero.



Vertical Scale: Sets the vertical scale of the current waveform. Turn clockwise to decrease the scale and anticlockwise to increase it. During the adjustment, the 'amplitude' of the waveform will enlarge or reduce and the scale message at the right side of the screen will also change. Press the knob to quickly switch the vertical scale adjustment modes between "Coarse" and "Fine".



T3DSO1104 / T3DSO1202A /
T3DSO1204 / T3DSO1302A

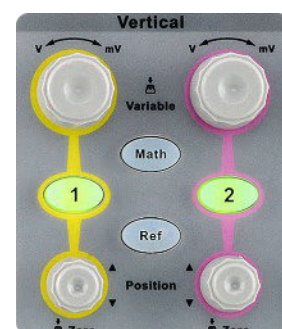

T3DSO1102

Math

Press the Math button to open math operation menu under which the operation of adding, subtracting, multiplying, dividing, FFT, integral, differential and square root are found.

Ref

Press the Ref button to enable the reference waveform function, enabling the user to compare the current waveform with the reference waveform.

Digital

Press the Digital button to open the digital channel function menu (Optional function). The T3DSO1104 / T3DSO1202A / T3DSO1204 and T3DSO1302A supports 16 digital channels with the appropriate options.

Run Control

Auto Setup

Press the Auto Setup button to enable the waveform auto setup function. The oscilloscope will automatically adjust the horizontal time base, vertical scale and trigger mode according to the input signal to provide a triggered stable display if possible. If the waveform is a single event waveform, or very infrequent waveform (such as a low repetitive rate pulse) then the Auto Setup function may not work. The oscilloscope should be set up manually in these cases.

Run Stop

Press the Run / Stop button to set the state of the instrument to "RUN" or "STOP". In the "RUN" state, the button glows yellow; In "STOP" state, the button glows red.

Universal Knob

Display Persist

Adjust Waveform Intensity / Graticule / Transparency

Press the Intensity knob, and use the knob to adjust the waveform intensity (from 0% ~ 100%). The graticule (from 0% ~ 100%) or transparency (from 20% ~ 80%) adjust in the same way as waveform intensity.



Universal Knob

In menu operation, when the light above the knob is lit, you could turn the knob to select between sub-menus under the current menu, and press the knob to select the current sub-menu. In addition, it can also be used to modify parameters and input filenames.

Function Menus

Cursors

Press the Cursors button to open the cursor function. It provides manual and tracking cursor mode.

Display Persist

Press the Display / Persist button to enter the display menu and quickly enabled the persistence function. Users can set the grid, intensity, graticule and transparency.



T3DSO1102

Function Menus continued



Press the Utility button to enter the utility menu. System functions and parameters, such as IO set, sound, language, can be set from this menu. In addition, some advanced functions (such as Pass/Fail, Do Self Cal, install option and Update) are also supported.



T3DSO1104 / T3DSO1202A / T3DSO1204 /
T3DSO1302A

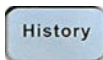

Press the History button to enter the history mode. The T3DSO1000 can record up to 80000 waveforms in history mode, depending on acquisition memory depth used.

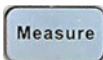

Press the Measure button to enter the measurement setting menu. The Measure menu allows the setting of measurement type, statistics function, all measurements and gated measurements. Four measurement parameters can be set. In statistics function, the Current value, Mean, Min, Max, Std-Dev and Count are shown on the screen. In all measure, all the parameters of the selected channel are shown.

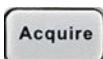

Press the Acquire button to enter the acquisition menu. You can set the acquisition mode to Normal / Peak-Detect / Average / Eres, interpolation mode (Sinx/X or linear), and memory depth. You can access and enable the XY function and sequence function.

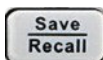

Press the Save / Recall button to enter the file save and recall function menu. The storable file types includes Setups, Waveforms, Picture and CSV.



Press the button to reset the oscilloscope to its default setup. A user can customize the default setup in the file save and recall function menu.

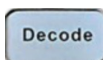

Press the Decode button to open the decode menu. Decode capability is a optional function. The T3DSO1000 supports two serial buses simultaneously including 1 and 2 for analog signal decoding. The protocols includes I2C, SPI, UART/RS232, CAN and LIN.

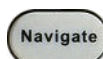

Press the Navigate button to turn off or turn on the navigate function. The T3DSO1104 / T3DSO1202A / T3DSO1204 / T3DSO1302A support three navigate types: time, search event, history frame.

Display Overview

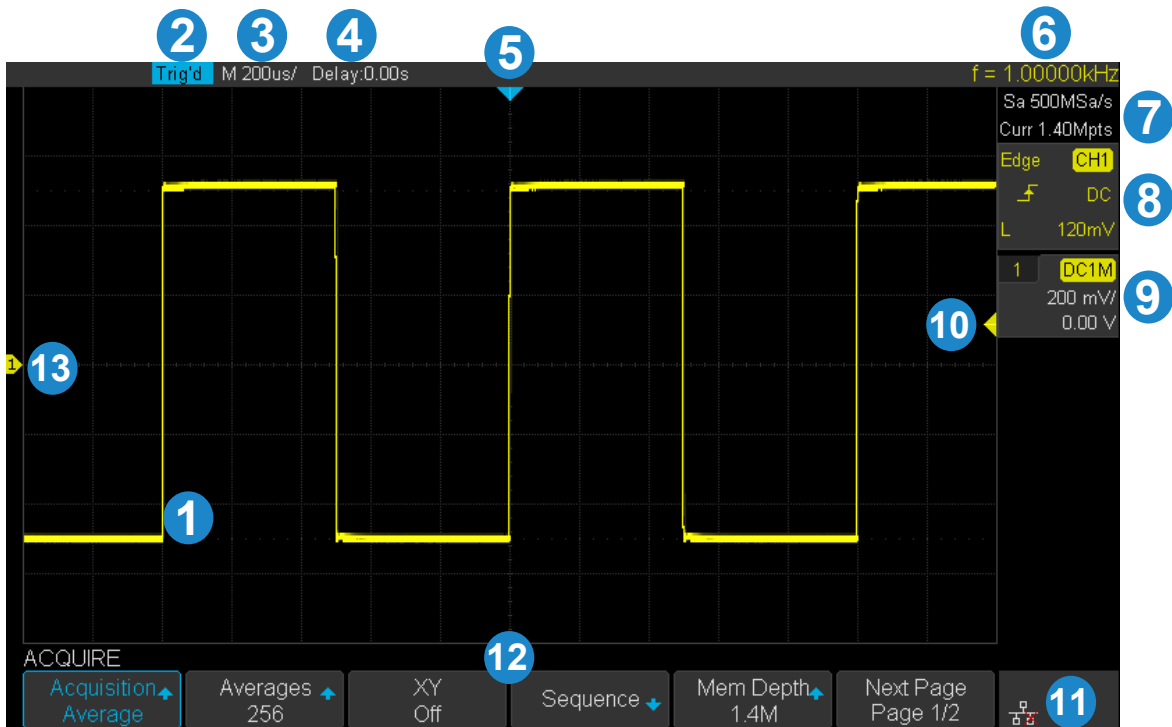

1. Waveform Display Area

Different channels are marked by different colors. The color of the waveform is the same as the color of the channel button and channel BNC connector.

2. Trigger state

Indication of the current trigger state. The possible trigger states are Arm, Ready, Trig'd, Stop, Auto.

3. Horizontal Time Base

The setting of the horizontal time per division. There are 14 divisions across the screen. Total time in the acquisition above is 200us per division or $14 \times 200\text{us} = 2.8\text{ms}$ across the screen. The time per division can be varied from 1ns ~ 100s.



4. Delay

Use horizontal **POSITION** knob to modify the zero time position on the display and thereby adjust the screen delay. Turn the knob clockwise or counterclockwise to adjust the waveform delay position. This will cause the Delay parameter value to decrease or increase. Press the knob to automatically reset the parameter to zero delay as well as return the waveform to the horizontal centre of the screen.



5. Trigger position

The blue triangle is the zero time indicator, see 4 above. Zero time is the trigger position, therefore the blue triangle also displays the trigger position on the screen.

6. Frequency Counter

Shows the frequency of the displayed waveform.

7. Sample Rate/Memory Depth

Display the current sample rate and memory depth of the oscilloscope. Use horizontal SCALE knob to modify the parameter.

8. Trigger Setting

Displays the trigger settings: Trigger Type, Trigger Channel, Trigger Coupling, Trigger Offset. The color of the settings reflects the channel that the oscilloscope will trigger on, in this example Ch1.

Coupling Mode options are DC / AC / LF Reject / HF Reject.

The trigger level value of the current waveform is shown. Press the knob to reset the parameter to 50% of the waveform.

9. Channel Setting

Display the channel settings including coupling mode. Options are: DC / AC / GND.

Displays the voltage Scale in Y axis volts per division.

BW Limit. If the "BW Limit" is "On", then a small capital "B" is displayed.

Channel Impedance is displayed (1 M Ω).

10. Trigger Level Position

Displays the voltage position of the trigger channel trigger level. Press the knob to reset the level to vertical center of the waveform.

11. Connection Status



Indicates the USB Host is connected.



Indicates that the WLAN port is disconnected



Indicates that the WLAN port is connected.



Indicates the LAN port is disconnected



Indicates the LAN port is connected.

12. Menu

The softkey menus of the currently selected function. Press any menu softkey to select the corresponding action.

13. Zero Voltage Level Indicator

Indicator of where the zero voltage level is for each channel. One color coded marker for each channel.

Troubleshooting

Commonplace problems and potential solutions are listed below. If the problem proves to be unsolvable, please contact Teledyne LeCroy Service Department as soon as possible for help and advice.

The screen remains blank after the power is turned on:

1. Check if the power is correctly connected.
2. Check if the power switch is off on the oscilloscope and wall socket connection.
3. Check whether the fuse has blown. If the fuse needs to be changed, please change the fuse for a fuse of the same specification. If this fuse blows immediately then please contact Teledyne LeCroy Service Department as soon as possible and return the instrument to the factory for repair.

After the signal is sampled, there is no corresponding waveform displayed:

1. Check if the probe is correctly connected to the DUT signal and to the oscilloscope BNC.
2. The probe can be checked by connecting it to the oscilloscope square wave compensation signal. This should produce a square wave on the scope display.
3. Check that the DUT is powered on and that it is generating waveforms.
4. Set the oscilloscope trigger to Auto. See if a waveform is displayed.

The voltage amplitude measured is higher or lower than the actual value (this error usually occurs when using a probe):

Check if the attenuation coefficient of the channel matches the attenuation ratio of the probe.

There is an unstable waveform displayed:

1. Check the trigger source: check whether the "Source" in the "TRIG" menu is the actual operating channel.
2. Adjust the trigger level. An unstable waveform can be displayed if the trigger waveform is noisy. The waveform can often be stabilised by adjusting the trigger level.
3. Check the trigger type: "Edge" trigger suits general waveforms but can produce unstable waveforms on burst type signals such as video, modulated waveforms and serial bus waveforms.
4. Check and adjust the trigger holdoff. Trigger Holdoff does not allow the trigger to re-arm for a specified length of time. This is very useful for stabilising burst type waveforms.

There is no waveform display after pressing Run / Stop:

Check whether the trigger Mode is "Normal" or "Single", and if the trigger level exceeds the waveform range. The oscilloscope will not trigger if the trigger level exceeds the size of the waveform and the oscilloscope is in Normal or Single mode.



Set the trigger to Auto Trigger and see if a waveform is displayed. The trigger level is usually out of range if the waveform is only displayed during Auto and not during Normal or Single. Alternatively the trigger type is incorrectly set up.

An aliased waveform is displayed:

The horizontal time base may be too low. Increase the horizontal time base to improve the horizontal resolution and remove the aliased waveform.

USB storage isn't recognized:

1. Not all USB storage is supported. Make sure the USB drive being used is flash and also check the size of the flash drive. Large USB flash storage is not supported.
2. USB 3.0 flash drives are not supported.



ABOUT TELEDYNE TEST TOOLS

Company Profile

Teledyne LeCroy is a leading provider of oscilloscopes, protocol analyzers and related test and measurement solutions that enable companies across a wide range of industries to design and test electronic devices of all types. Since our founding in 1964, we have focused on creating products that improve productivity by helping engineers resolve design issues faster and more effectively. Oscilloscopes are tools used by designers and engineers to measure and analyze complex electronic signals in order to develop high-performance systems and to validate electronic designs in order to improve time to market.

The Teledyne Test Tools brand expands on the Teledyne LeCroy product portfolio by adding a comprehensive range of test equipment solutions for its customers. The new range of product solutions deliver engineers with a broad range of quality test solutions that enables speed to market product validation and design. More and more designers, engineers and lecturers are relying on Teledyne Test Tools to meet their testing, education and electronics validation needs with confidence and within budget.

Location and Facilities

Headquartered in Chestnut Ridge, New York, Teledyne Test Tools and Teledyne LeCroy have sales, service and development subsidiaries in the US and throughout Europe and Asia. Teledyne Test Tools and Teledyne LeCroy products are employed across a wide variety of industries, including semiconductor, computer, consumer electronics, education, military/aerospace, automotive/industrial, and telecommunications.

Teledyne LeCroy (US Headquarters)

700 Chestnut Ridge Road
Chestnut Ridge, NY. USA
10977-6499
Phone: 800-553-2769 or 845-425-2000
Fax Sales: 845-578-5985
Email Sales: contact.corp@teledynelecroy.com
Email Support: support@teledynelecroy.com
(Oscilloscopes, Waveform Generators, Signal Integrity)
Web Site: <http://teledynelecroy.com/>
Phone Support: 1-800-553-2769

Teledyne LeCroy (European Headquarters)

Teledyne LeCroy GmbH
Im Breitspiel 11c
D-69126 Heidelberg, Germany
Phone: + 49 6221 82700
Fax: +49 6221 834655
Fax Sales: +49 6221 834655 **Fax**
Service: +41 22 719 22 99
Email Sales: contact.gmbh@teledynelecroy.com
Email Service: service.gmbh@teledynelecroy.com
Email Support: applications.de@teledynelecroy.com
Web Site: <http://teledynelecroy.com>
Phone Service: +49 6221 8270 85
Phone Support: +49 6221 8270 28



User Manual

T3DSO1000 / T3DSO1000A Series Digital Oscilloscope



© 2021 Teledyne LeCroy, Inc. All rights reserved.

Users are permitted to duplicate and distribute Teledyne LeCroy, Inc. documentation for internal educational purposes only. Resale or unauthorized duplication of Teledyne LeCroy publications is strictly prohibited.

Teledyne Test Tools is a trademark of Teledyne LeCroy, Inc., Inc. Other product or brand names are trademarks or requested trademarks of their respective holders. Information in this publication supersedes all earlier versions.

Specifications are subject to change without notice.

Contact Us

Teledyne LeCroy (US Headquarters)

700 Chestnut Ridge Road
Chestnut Ridge, NY. USA
10977-6499

Phone: 800-553-2769 or 845-425-2000

Fax Sales: 845-578-5985

Email Sales: contact.corp@teledynelecroy.com

Email Support: support@teledynelecroy.com

(Oscilloscopes, Waveform Generators, Signal Integrity)

Web Site: <http://teledynelecroy.com/>

Phone Support: 1-800-553-2769

Teledyne LeCroy (European Headquarters)

Teledyne LeCroy GmbH Im

Breitspiel 11c

D-69126 Heidelberg, Germany

Phone: + 49 6221 82700

Fax: +49 6221 834655

Fax Sales: +49 6221 834655

Fax Service: +41 22 719 22 99

Email Sales: contact.gmbh@teledynelecroy.com

Email Service: service.gmbh@teledynelecroy.com

Email Support: tlc.t3.appsupport.eu@teledyne.com

Web Site: <http://teledynelecroy.com>

Phone Service: +49 6221 8270 85

Phone Support: +49 6221 8270 28

Safety Information

General Safety Summary

Carefully read the following safety precautions to avoid any personal injury or damage to the instrument and any products connected to it. To avoid potential hazards, please use the instrument as specified.

Use Proper Power Line

Only the power cord designed for the instrument and country should be used.

Ground the Instrument

The instrument is grounded through the protective earth conductor of the power line. To avoid electric shock, please make sure the instrument is grounded correctly before connecting its input or output terminals.

Connect the Signal Ground Wire Correctly

The potential of the signal ground wire is equal to earth, so do not connect the signal ground wire to a high voltage.

Look Over All Terminal Ratings

To avoid fire or electric shock, please look over all ratings and sign instructions of the instrument. Before connecting the instrument, please read the manual carefully to gain more information about the ratings.

Use Proper Overvoltage Protection

Make sure that no overvoltage (such as that caused by a thunderstorm) can reach the product, or else the operator might be exposed to the danger of electrical shock.

Electrostatic Prevention

Operate in an electrostatic discharge protective environment to avoid damage induced by static discharge. Always ground both the internal and external conductors of any cables to discharge static before connecting.

Keep Ventilated

Inadequate ventilation may cause increasing product temperature, which will eventually damage the instrument. So keep well ventilated and inspect the intake and fan regularly.

Avoid contact with Exposed Circuit or Components

Do not touch exposed contacts or components when the power is on.

Use proper Fuse

Use only the specified fuse.

Do Not Operate Without Covers

Do not operate the instrument with covers or panels removed.

Do Not Operate With Suspected Failures.

If you suspect damage occurs to the instrument, have it inspected by qualified service personnel before further operations. Any maintenance, adjustment or replacement especially to circuits or accessories must be performed by **Teledyne Test Tools** authorized personnel.

Do Not Operate in Wet Conditions.

In order to avoid short circuiting the interior of the device or electric shock, please do not operate in a high humidity environment.

Do Not Operate in an Explosive Atmosphere.

In order to avoid damage to the device or personal injuries, it is important to operate the device away from an explosive atmosphere.

Keep Product Surfaces Clean and Dry.

To avoid the influence of dust and/or moisture in the air, please keep the surface of the instrument clean and dry.

Handling Safety

Please handle with care during transportation to avoid damages to buttons, knob interfaces and other parts on the panels.

Only probe assemblies which meet the manufacturer's specifications shall be used.

When using 2X/.../10000X probe assemblies, the probe assemblies shall be insulated from the measured circuits by double or reinforced insulation.

All probe assemblies should meet the requirements of UL 61010-031 and CAN/CSA-C22.2 No. 61010-031-07.

If the equipment is used in a manner not specified by the manufacturer, the protection provided by the equipment may be impaired.

Safety Terms and Symbols

Terms in this Manual. These terms may appear in this manual:



WARNING

Warning statements indicate the conditions or practices that could result in injury or loss of life.



CAUTION

Caution statements indicate the conditions or practices that could result in damage to this product or other property.

Terms on the product. These terms may appear on the product:

DANGER Indicates direct injuries or hazards that may happen.

WARNING Indicates potential injuries or hazards that may happen.

CAUTION Indicates potential damage to the instrument or other property that may happen.

Symbols on the product. These symbols may appear on the product:



**Hazardous
Voltage**



**Protective Earth
Terminal**



Warning



**Test
Ground**



Power Switch

If such symbols appear on the product, consult the manual to find out the nature of the potential hazard and the actions which have to be taken.

Measurement Category

Measurement Categories

This oscilloscope can only make measurements in circuits that are not directly connected to mains.



WARNING

This oscilloscope can only be used for measurements within its specified measurement categories.

Do not use the product for measurements within other measurement categories, such as CAT II, CAT III, CAT IV.

Do not use the equipment for measurements on mains circuits

Measurement Category Definitions

Measurement category II is for measurements performed on circuits directly connected to the low voltage installation. Examples are measurements on household appliances, portable tools and similar equipment.

Measurement category III is for measurements performed in the building installation. Examples are measurements on distribution boards, circuit-breakers, wiring, including cables, bus-bars, junction boxes, switches, socket-outlets in the fixed installation, and equipment for industrial use and some other equipment, for example. Stationary motors with permanent connection to the fixed installation.

Measurement category IV is for measurements performed at the source of the low-voltage installation. Examples are electricity meters and measurements on primary over current protection devices and ripple control units.

Working Environment

Temperature

Operating: 10°C to +40°C

Non-operation: -20°C to +70°C

Humidity

Under +35°C: ≤90% relative humidity

+35°C to +40°C: ≤60% relative humidity



WARNING

To avoid short circuit inside the instrument or electric shock, please do not operate in a humid environment.

Altitude

Operating: less than 3 Km

Non-operation: less than 15 Km

Degree of protection

IP20

Installation (over voltage) Category

This product is powered by mains conforming to installation (overvoltage) category II.



WARNING

Make sure that no over voltage (such as that caused by thunderbolt) can reach the product, or else the operator might expose to the danger of electric shock.

Installation (over voltage) Category Definitions

Installation (over voltage) category I refers to signal level which is applicable to equipment measurement terminals connected to the source circuit. In these terminals, precautions are done to limit the transient voltage to the corresponding low level.

Installation (over voltage) category II refers to the local power distribution level which is applicable to equipment connected to the AC line (AC power).

Ventilation Requirement

This oscilloscope uses a fan for cooling. Please make sure that the air intake and exhaust areas are free from obstructions and have free air. When using the oscilloscope in a bench-top or rack setting, provide at least 10 cm clearance beside, above and behind the instrument for adequate ventilation.



WARNING

Inadequate ventilation may cause temperature increase which would damage the instrument. So please keep the instrument well ventilated during operation and inspect the intake and fan regularly.

General Care and Cleaning

Care

Do not store or leave the instrument in direct sunshine for long periods of time.



WARNING

To avoid damage to the instrument or probe, please do not leave them in fog, liquid, or solvent.

Cleaning

Please perform the following steps to clean the instrument and probe regularly according to its operating conditions.

1. Disconnect the instrument from all power sources, and then clean it with a soft wet cloth.
2. Clean the loose dust on the outside of the instrument and probe with a soft cloth. When cleaning the LCD, take care to avoid scarifying it.



WARNING

To avoid damage to the surface of the instrument and probe, please do not use any corrosive liquid or chemical cleanser.



WARNING

Make sure that the instrument is completely dry before restarting it to avoid short circuits or personal injuries.

Document Overview

This manual describes how to use the digital oscilloscope in detail.

Quick Start	Provide information about preparation before using the instrument and a brief introduction to the instrument.
Set the Vertical System	Introduce the functions of the vertical system of the oscilloscope.
Set the Horizontal System	Introduce the functions of the horizontal system of the oscilloscope.
Set the Sampling System	Introduce the functions of the sampling system of the oscilloscope.
Trigger the Oscilloscope	Introduce the trigger mode, trigger coupling, trigger hold off, external trigger and various trigger types of the oscilloscope.
Serial Trigger	Introduce how to trigger on serial input signals.
Save Reference Waveforms	Introduce how to save and display REF waveforms.
How To Make Math Operations	Introduce the math operation function of the oscilloscope.
How To Make Cursor Measurements	Introduce how to use cursors to make measurements.
How To Use Measurement Functions	Introduce how to use the measurement function to measure the waveform parameters.
Display Settings	Introduce how to set up the oscilloscope display.
Save and Recall	Introduce how to save and recall the measurement result and the settings of the oscilloscope.
System Settings	Introduce how to adjust the system setup.
Default	Introduce the Default setup of the oscilloscope
Troubleshooting	Introduce how to deal with common failures of the oscilloscope.

Table of Content

Copyright and Declaration	I
Safety Information	II
General Safety Summary	II
Safety Terms and Symbols	IV
Measurement Category	V
Working Environment	VI
Ventilation Requirement	VII
General Care and Cleaning	VIII
Document Overview	IX
Quick Start	1
General Inspection	2
Appearance and Dimensions	3
To Prepare the Oscilloscope for Use	5
To Adjust the Supporting Legs	5
To Connect to Power Supply	6
Power-on Inspection	7
To Connect the Probe	7
Function Inspection	8
Probe Compensation	9
Front Panel Overview	10
Rear Panel Overview	12
Front Panel Function Overview	14
Horizontal	14
Vertical	15
Trigger	16
Run Control	17
Universal Knob	18
Menu	19
Help	21
User Interface	22
To Use the Security Lock	24
To Set the Vertical System	25
To Enable the Channel	26
To Adjust the Vertical Scale	27
To Adjust the Vertical Position	27
To Specify Channel Coupling	28
To Specify Bandwidth Limit	28
To Specify Probe Attenuation Factor	29
To Specify channel Input Impedance	29
To Specify Amplitude Unit	30
To Specify Deskew	30
To Invert a Waveform	30

Set the Horizontal System	31
Adjust the Horizontal Scale	32
Adjust Trigger Delay	33
Set the Roll mode	34
Use the Zoom Function	35
To Set the Sample System	36
Run Control	37
Overview of Sampling	38
Sampling Theory	38
Sample Rate	39
Oscilloscope Bandwidth and Sample Rate	40
Select Memory Depth	41
Select Sampling Mode	42
Select Waveform Interpolation Method	43
Select Acquisition Mode	45
Normal	45
Peak Detect	46
Average	47
High Resolution	48
Change the Horizontal Format	49
Use Sequence Mode	50
To Trigger the Oscilloscope	52
Trigger Source	54
Trigger Mode	55
Trigger Level	56
Trigger Coupling	57
Trigger Holdoff	58
Noise Rejection	59
Trigger Type	61
Edge Trigger	62
Slope Trigger	63
Pulse Trigger	65
Video Trigger	67
Window Trigger	70
Interval Trigger	73
DropOut Trigger	75
Runt Trigger	77
Pattern Trigger	79
Serial trigger and decode	81
I2C Trigger and Serial Decode	82
Setup for I2C Signals	82
I2C Triggering	84
I2C Serial Decode	88
SPI Triggering and Serial Decode	90

Setup for SPI Signals	90
SPI Triggering	93
SPI Serial Decode	95
UART/RS232 Triggering and Serial Decode	97
Setup for UART/RS232 Signals	97
UART/RS232 Triggering	99
UART/RS232 Serial Decode	101
CAN Trigger and Serial Decode	103
Setup for CAN Signals	103
CAN Triggering	105
CAN Serial Decode	107
LIN Triggering and Serial Decode	109
Setup for LIN Signals	109
LIN Triggering	110
LIN Serial Decode	112
To Save Reference Waveform	114
To Save REF Waveform to Internal Memory	115
To Display REF Waveform	115
To Adjust REF Waveform Display	116
To Clear REF Waveform Display	117
To Make Math Operation	118
Units for Math Waveforms	118
Math Operators	119
Addition or Subtraction	119
Multiplication and Division	120
FFT Operation	121
Math Function Operation	124
Differentiate	124
Integrate	125
Square Root	126
To Make Cursors Measurements	128
X Cursors	128
Y Cursors	128
To Make Cursor Measurements	129
To Make Measurements	130
Type of Measurement	131
Voltage Measurements	131
Time Measurements	133
Delay Measurements	134
To Make Automatic Measurement.....	135
To Clear Measurement Parameters	137
To Make All Measurement	137
Display Setting	138
To Set Display Type	139

To Set Color Display	140
To Set and Clear Persistence	140
To clear the display	141
To Select Grid Type	142
To Adjust Waveform Intensity	142
To Adjust Grid Brightness	143
To Adjust Transparence	143
Save and Recall	144
Save Type	145
Internal Save and Recall	147
External save and recall	148
Disk Management	151
To Create a New File or Folder	152
To delete a file or folder	153
Digital Channels(Optional)	154
To Connect the Digital Probes to the Device-under-test	155
Acquiring Waveform Using the Digital Channels	156
To Change the Display Type of the Digital Channels	156
To Switch a Single Channel On or Off	157
To Switch All Digital Channels On or Off	157
To Change the Logic Threshold for Digital Channels	158
To Reposition a Digital Channel	158
To Display Digital Channels as a Bus	159
System Function Setting	160
To View the System Status	161
To Do Self Calibration	162
To Enable or Disable the Sound	163
To Specify the Language	163
To Do Pass/Fail Test	164
To Set and Perform Pass/Fail Test	165
To Save and Recall Test Mask	166
Arbitrary Waveform Generator(Optional)	168
Output	169
Wave	169
Setting	171
Systems	173
Remove Device	174
IO Set	175
To Set the USB Device	175
To Set the LAN	176
To Set the WLAN (Option)	177
To Set Aux Output	178
To Use the Web Server	179
To Update Firmware and Configuration	180

Do Self Test	181
Screen Test	181
Keyboard Test	182
LED Test	183
To specify Screen Saver Time	184
To Use the Expand Setting	185
To Use the Power On Line	185
Option Management	186
Search	188
Setting	188
Results	189
Navigate	191
Time navigate	191
History frame navigate	191
Search event navigate	191
Bode Plot	193
Perform Bode Plot application	193
Setting	193
To Use the History Function	196
Factory Setup	198
Troubleshooting	202
Certifications	204

Content of Figure

Figure 1 Front View (T3DSO1102 scope)	3
Figure 2 Top View (T3DSO1102 scope)	3
Figure 3 Front View (All models except T3DSO1102)	4
Figure 4 Top View (All models except T3DSO1102)	4
Figure 5 Adjust the Supporting Legs	5
Figure 6 To Connect to Power Supply	6
Figure 7 Function Inspection	8
Figure 8 T3DSO1102 Scope Front Panel Overview	10
Figure 9 Scope Front Panel Overview (All models except T3DSO1102)	11
Figure 10 T3DSO1102 Scope Rear panel Overview	12
Figure 11 Scope Rear panel Overview (All models except T3DSO1102)	13
Figure 12 Help Message	21
Figure 13 User Interface	22
Figure 14 To Use the Security Lock	24
Figure 15 Display Type Set to Dots.....	43
Figure 16 x Interpolation.....	44
Figure 17 Sinx/x Interpolation.....	44
Figure 18 Acquisition System	45
Figure 19 Pulse With 0.1% Duty, Normal Mode	46
Figure 20 Pulse With 0.1% Duty, Peak Detect Mode	46
Figure 21 With Random Noise, Normal Mode	47
Figure 22 With Random Noise, Average Mode	48
Figure 23 SEQUENCE FuncMen Menu	50
Figure 24 HISTORY Function Menu	50
Figure 25 Turn off the Noise Reject	59
Figure 26 Turn on the Noise Reject	60
Figure 27 Edge Trigger	62
Figure 28 Slope Trigger	64
Figure 29 Pulse Trigger	66
Figure 30 Video Trigger	69
Figure 31 Absolute Window Trigger	71
Figure 32 Relative Window Trigger	72
Figure 33 Interval Trigger	74
Figure 34 Edge DropOut Trigger	76
Figure 35 State DropOut Trigger	77
Figure 36 Runt Trigger	78
Figure 37 Pattern Trigger	80
Figure 38 I2C DECODE Menu	82
Figure 39 I2C SIGNAL Menu	82
Figure 40 I2C Trigger Menu	87
Figure 41 I2C DECODE Menu	88

Figure 42 SPI SIGNAL Menu	91
Figure 43 SPI CLOCK Menu	91
Figure 44 MISO Menu	91
Figure 45 MOSI Menu	91
Figure 46 SPI TRIG SET Menu	93
Figure 47 UART SIGNAL Menu	97
Figure 48 UART / RS232 Bus Config Menu	98
Figure 49 UART TRIG SET Menu	99
Figure 50 UART Trigger	100
Figure 51 UART / RS232 Decode	101
Figure 52 CAN SIGNAL Menu	103
Figure 53 CAN Trigger	106
Figure 54 LIN SIGNAL Menu	109
Figure 55 LIN Trigger	111
Figure 56 LIN Decode	112
Figure 57 Reference Waveform	116
Figure 58 AddiMbn	119
Figure 59 FFT Waveform in Split Mode	123
Figure 60 Differential Function Operation	125
Figure 61 Integral Without Offset	126
Figure 62 Integral With Offset	126
Figure 63 Square Root	127
Figure 64 Measure Pulse Width	129
Figure 65 Voltage Measurements	131
Figure 66 Overshoot	132
Figure 67 Preshoot	132
Figure 68 Time Measurements	133
Figure 69 Select the Measurement Parameter	135
Figure 70 Added the Measurements	136
Figure 71 All Parameters Measurement	137
Figure 72 Vector Display	139
Figure 73 Dots Display	139
Figure 74 Color Temperature	140
Figure 75 Persist Set To Infinite	141
Figure 76 SAVE / RECALL File System	148
Figure 77 Select Save LocaMbn	149
Figure 78 File Name Dialogue	149
Figure 79 Input Keyboard	152
Figure 80 Digital Function Menu	156
Figure 81 Digital Channel Height	156
Figure 82 Digital: High Display Type	157
Figure 83 Digital Thresholds FuncMbn Menu	158
Figure 84 Digital Bus Function Menu	159
Figure 85 Digital Bus	159

Figure 86 System Status	161
Figure 87 Do Self Cal	162
Figure 88 Pass / Fail Test	164
Figure 89 AWG Menu Interface	169
Figure 90 Wave Type Interface	169
Figure 91 Built-in Arb Interface	171
Figure 92 AWG Setting Interface	171
Figure 93 AWG System Information Interface	173
Figure 94 AWG Update Interface	174
Figure 95 LAN Settings	176
Figure 96 WIFI Setting Menu	177
Figure 97 Web Server Interface	179
Figure 98 Screen Test	181
Figure 99 Keyboard Test	182
Figure 100 LED Test	183
Figure 101 Screen Saver Interface	184
Figure 102 OPTION Function menu	186
Figure 103 LABEL Function Menu	186
Figure 104 Option Information	187
Figure 105 Search Menu	188
Figure 106 Search When Stopped	190
Figure 107 Search When Running	190
Figure 108 Bode Plot Menu	193
Figure 109 Bode Plot Configure Menu	193
Figure 110 Bode Plot Display Menu	194
Figure 111 Bode Plot Data Menu	195
Figure 112 Bode Plot List On	195
Figure 113 History	196

Quick Start

This chapter introduces the preparations when using the oscilloscope for the first time, the front panel, rear panel and user interface.

The contents of this chapter:

- ◆ General Inspection
- ◆ Appearance and Dimensions
- ◆ To Prepare the Oscilloscope for Use
- ◆ Front Panel Overview
- ◆ Rear Panel Overview
- ◆ Front Panel Function Overview
- ◆ Back Panel Function Overview
- ◆ User Interface
- ◆ To Use the Security Lock

General Inspection

1. Inspect the shipment for damage.

Keep the shipping box and cushioning material until the contents of the shipment have been checked for completeness and the instrument has passed both electrical and mechanical tests.

The shipper or carrier shall be liable for the damage to instrument resulting from shipment. **Teledyne Test Tools** would not be responsible for free maintenance / rework or replacement of the unit.

2. Inspect the instrument.

In case of any damage, or defect, or failure, notify your **Teledyne Test Tools** sales representative.

3. Check the Accessories

Please check the accessories according to the packing lists. If the accessories are incomplete or damaged, please contact your **Teledyne Test Tools** sales representative.

Appearance and Dimensions

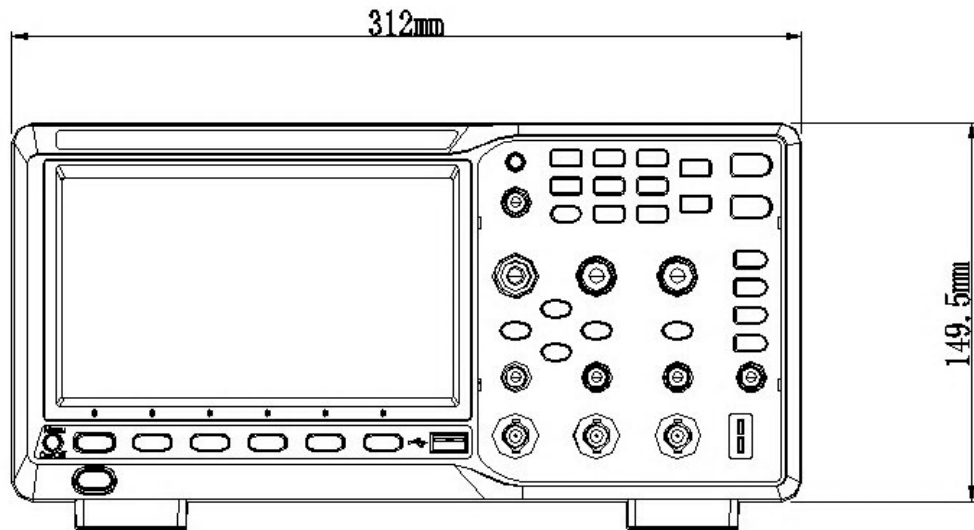

Figure 1 Front View (T3DSO1102 scope)

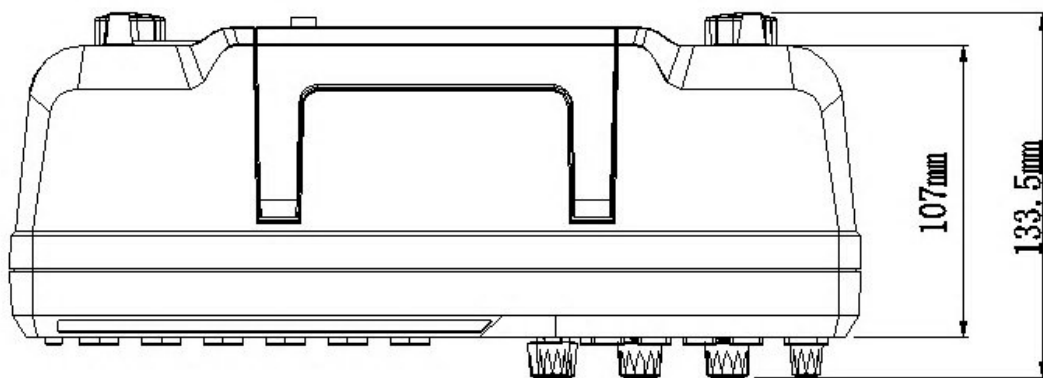

Figure 2 Top View (T3DSO1102 scope)

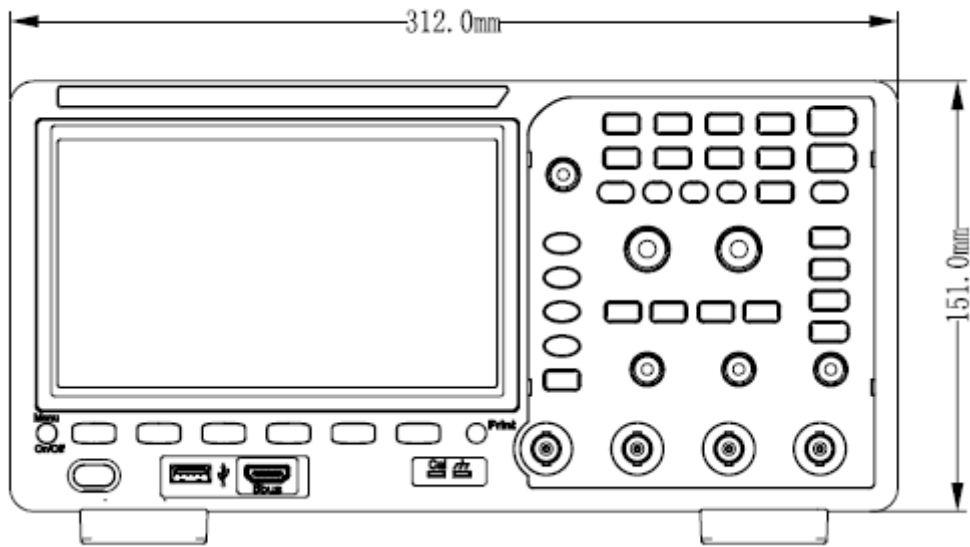

Figure 3 Front View (All scopes except T3DSO1102)

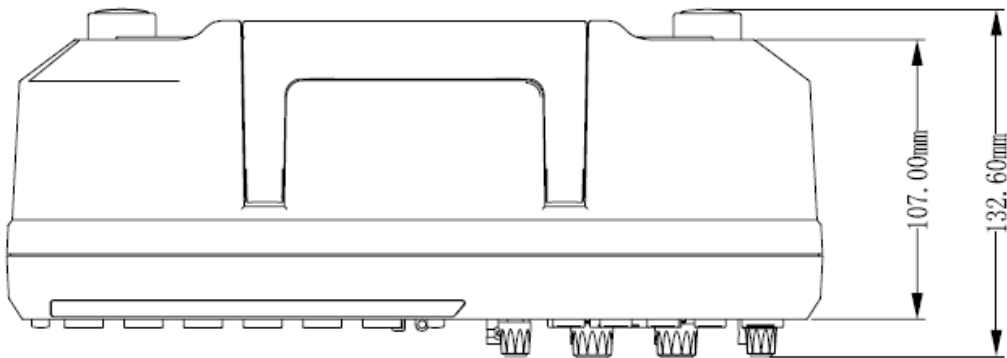

Figure 4 Top View (All scopes except T3DSO1102)

To Prepare the Oscilloscope for Use

To Adjust the Supporting Legs

Adjust the supporting legs properly to use them as stands to tilt the oscilloscope upwards for stable placement of the oscilloscope as well as better operation and observation.

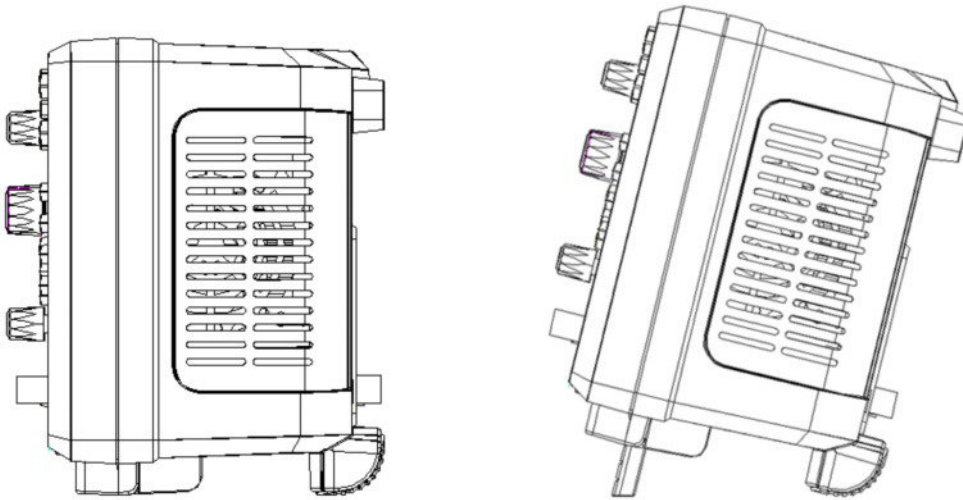

Figure 5 Adjust the Supporting Legs

To Connect to the local line Power

The power requirements of the oscilloscope are 100-240 V, 50/60Hz or 100-120 V, 400Hz. Please use the power cord supplied with the accessories to connect the oscilloscope to the power source.

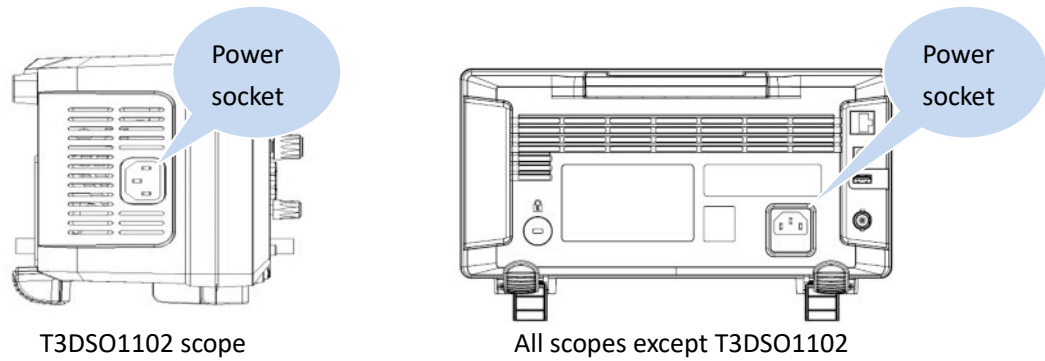

Figure 6 To Connect to Power Supply

Power-on Inspection

When the oscilloscope is connected to line power, press the power key at the lower-left corner of the front panel to start the oscilloscope. During the start-up process, the oscilloscope performs a series of self-tests and you can hear the sound of relays switching. After the self-test is finished, the welcome screen is displayed.

To Connect the Probe

Teledyne Test Tools provides passive probes for the oscilloscopes. For detailed technical information of the probes, please refer to the corresponding Probe User's Guide.

Connect the Probe:

1. Connect the probe to an oscilloscope front channel BNC.
2. Connect the probe tip to the circuit point to be tested and connect the ground alligator clip of the probe to the circuit ground terminal.

Function Inspection

1. Press the **Default** button on the front panel to restore the instrument to its default configuration.
2. Connect the ground alligator clip of the probe to the “Ground Terminal” under the probe compensation signal output terminal.

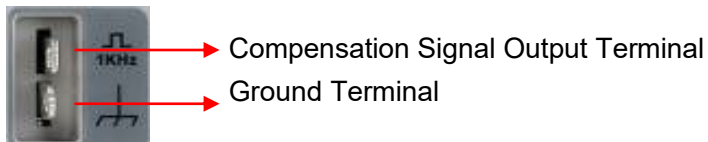

T3DSO1102 scope

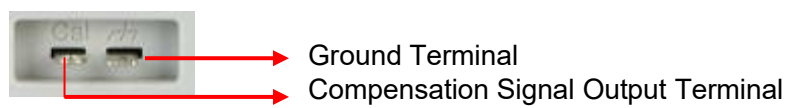

All scopes except T3DSO1102

3. Use the probe to connect the input terminal of CH1 of the oscilloscope to the “Compensation Signal Output Terminal” of the oscilloscope.
4. Press the **Auto Setup**.
5. Observe the waveform on the display. In normal condition, the display should be a square waveform as shown in the figure below:

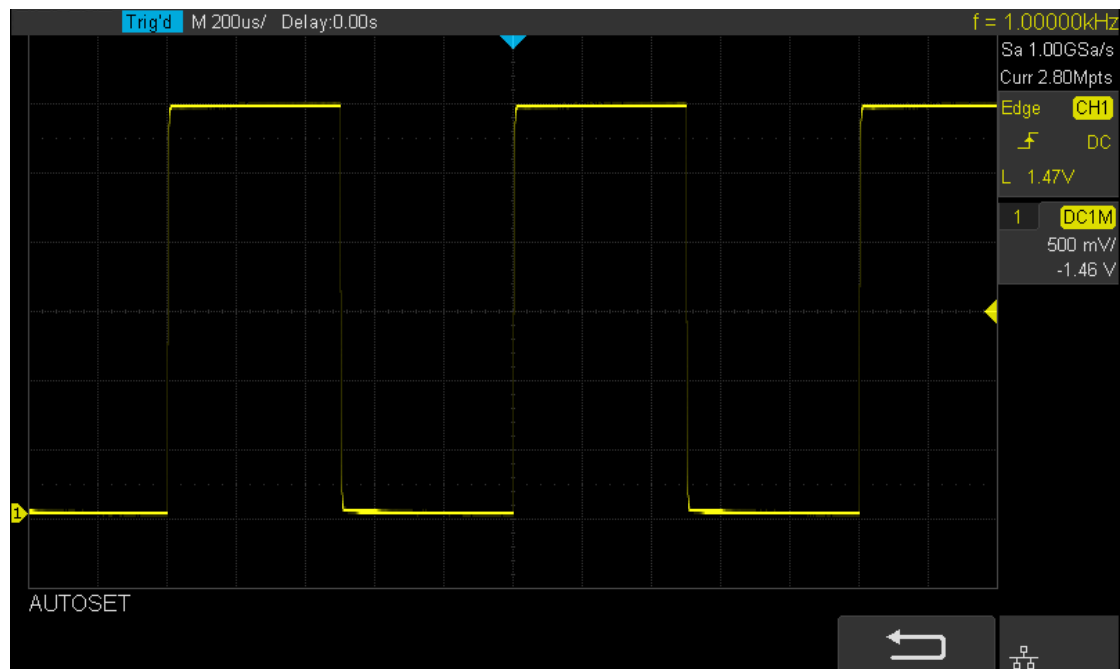

Figure 7 Function Inspection

6. Use the same method to test the other channels. If the square waveforms actually shown do not match that in the figure above, please perform “**Probe Compensation**”, as detailed in the next section.

WARNING

To avoid electric shock during the use of a probe, please make sure that the insulated wire of the probe is in good condition and do not touch the metallic part of the probe when the probe is connected to a high voltage source

Probe Compensation

When the probes are used for the first time, you should compensate the probes to match the input channels of the oscilloscope. Non-compensated or poorly compensated probes may cause measurement inaccuracy or error. The probe compensation procedures are as follows.

1. Set the switch to 10X on the probe.
2. Perform steps 1, 2, 3 and 4 of **“Function Inspection”** in the previous section.
3. Check the waveforms displayed and compare them with the following:

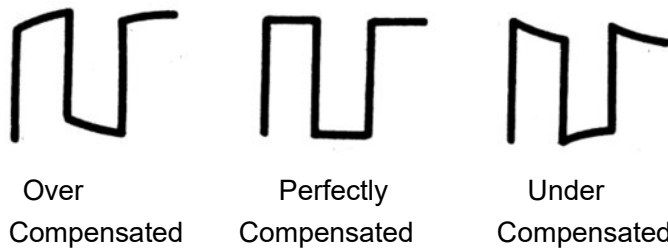

4. Use a nonmetallic screwdriver to adjust the low-frequency compensation adjustment hole on the probe until the waveform displayed is as the “Perfectly compensated” waveform in the figure above.

Front Panel Overview



Figure 8 T3DSO1102 Scope Front Panel Overview

NO.	Description	NO.	Description
1	LCD Display	8	Vertical Control
2	Universal Knob	9	Probe Compensation/ Ground Terminal
3	Common Function Menus	10	Analog Channel and Ext Input
4	Run/Stop	11	USB Host
5	Auto Setup	12	Menu Softkey
6	Trigger Control	13	Menu on/off
7	Horizontal Control	14	Power Button



Figure 9 All Scopes except T3DSO1102 Front Panel Overview

NO.	Description	NO.	Description
1	LCD Display	12	Horizontal Control
2	Universal Knob	13	Trigger Control
3	Common Function Menus	14	Menu on/off
4	Clear Sweeps	15	Menu Softkey
5	Run/Stop	16	One- Button shortcut for Save
6	Decode	17	Analog Channel
7	Auto Setup	18	Power Button
8	Navigate	19	USB Host
9	History	20	Digital Inputs
10	Default	21	Probe Compensation/ Ground Terminal
11	Vertical Control, Math, REF and Digital		

Rear Panel Overview

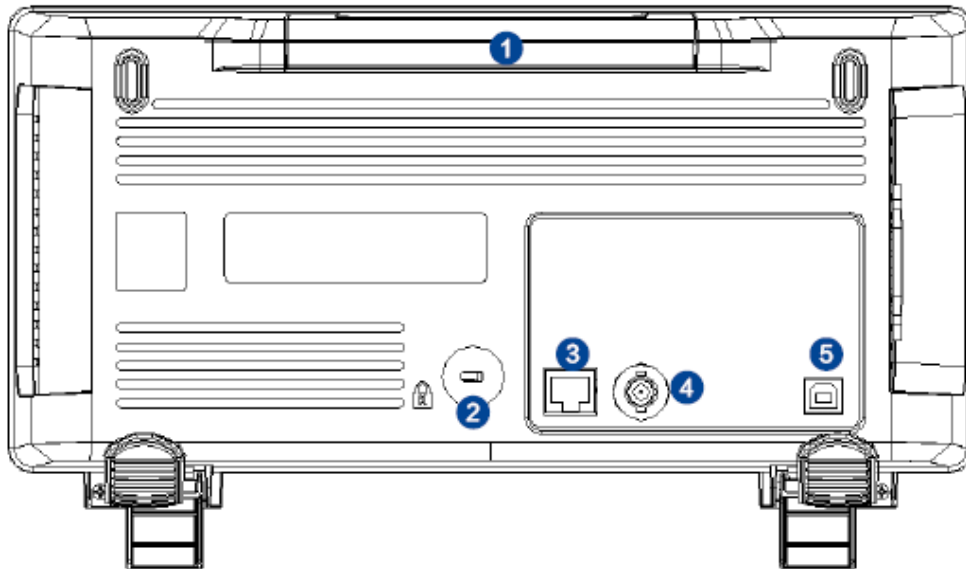

Figure 10 T3DSO1102 Scope Rear panel Overview

1. Handle

Pull up the handle vertically for easy carrying of the instrument. When you do not need the handle, press it down.

2. Safety lock Hole

You can lock the instrument to a fixed location using the security lock (not supplied) via the lock hole.

3. LAN

The instrument can be connected to network via this interface to perform remote control.

4. Pass/Fail or Trigger Out

The BNC port can output a signal that reflects the current waveform capture rate of the oscilloscope at each trigger or a pass/fail test pulse.

5. USB Device

The oscilloscope support SCPI remote control commands, user can control the oscilloscope through this interface.

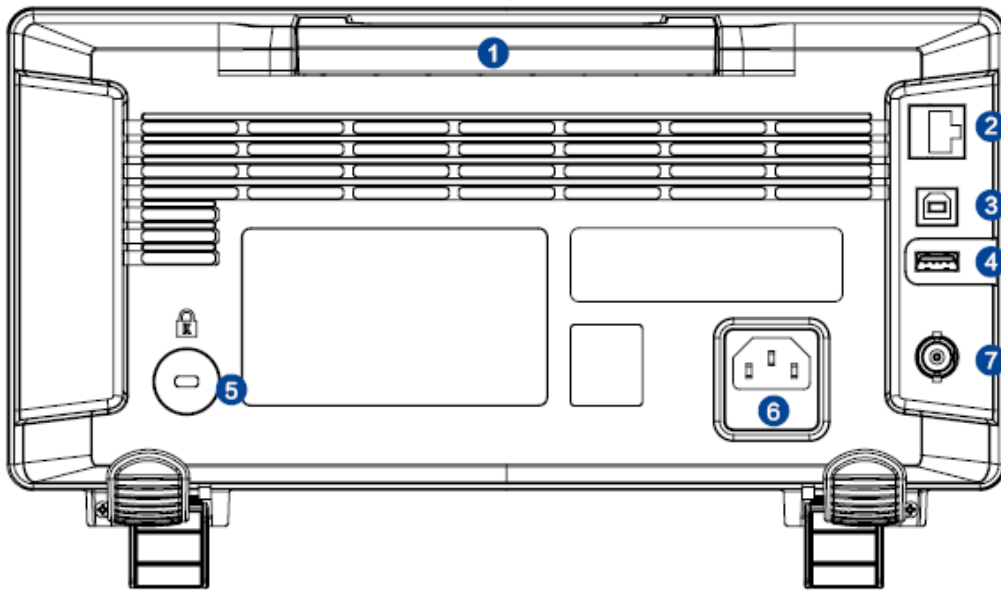

Figure 11 All Scopes Except T3DSO1102 Rear panel Overview

1. Handle

Pull up the handle vertically for easy carrying of the instrument. When you do not need the handle, press it down.

2. LAN

The instrument can be connected to network via this interface to perform remote control.

3. USB Device

The oscilloscope support SCPI remote control commands, user can control the oscilloscope through this interface

4. USB Host

5. Safety lock Hole

You can lock the instrument to a fixed location using the security lock (not supplied) via the lock hole.

6. AC Power Socket

AC power input connector. The power requirements of this oscilloscope are 100-240 V, 50/60/400 Hz. Use the power cord provided with the instrument to connect it to AC power.

7. Pass/Fail or Trigger Out

The BNC port can output a signal that reflects the current waveform capture rate of the oscilloscope at each trigger or a pass/fail test pulse.

Front Panel Function Overview

Horizontal



All scopes Except T3DSO1102



T3DSO1102 scope



: Quickly enter the roll mode. The timebase range is from 50mS/div to 100S/div.



: Enable or disable search function. This function can search for the events that users specify in the acquired data, the results are displayed with a white triangle symbol.

Horizontal Position Knob



: adjust horizontal position. The trigger point would move left or right relative to the center of the screen when you turn the knob. During the modification, waveforms of all the channels would move left or right and the trigger position message at the upper-right corner of the screen would change accordingly. Press down this knob to quickly reset the trigger delay to Zero.

Horizontal Scale Knob



: adjust the horizontal time base. Turn clockwise to reduce the time base and turn counterclockwise to increase the time base. During the modification, waveforms of all the channels will be displayed in expanded or compressed mode and the time base message at the upper-left side of the screen would change accordingly. Press down this knob to quickly turn on Zoom function.

Vertical

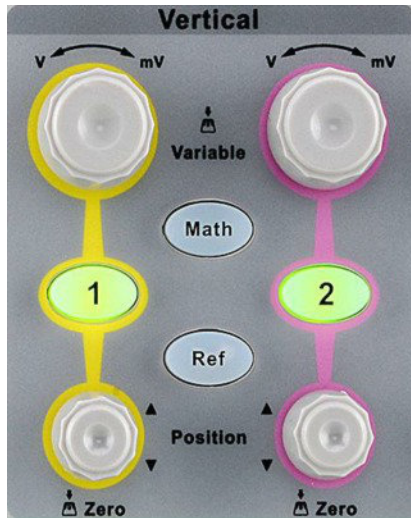



T3DSO1102 2-channel scope



T3DSO1104, T3DSO1202A,
T3DSO1204, T3DSO1302A

- 1** : Analog input channels. The two channels are marked by different colors which are also used to mark both the corresponding waveforms on the screen and the channel input connectors.

Vertical Position Knob  : adjust the vertical position of the current channel waveform. Turn clockwise to increase the position and turn counterclockwise to decrease. During the modification, the waveform would move up and down and the position message at the lower-left corner of the screen would change accordingly. Press down this knob to quickly reset the vertical position to zero.

Vertical Variable Knob  : adjust the vertical scale of the current channel. Turn clockwise to decrease the scale and turn counterclockwise to increase. During the modification, the amplitude of the waveform would enlarge or reduce and the scale information at the right side of the screen would change accordingly. Press down this knob to quickly switch the vertical scale adjustment modes between “Coarse” and “Fine”.

Math : press the button to enter the MATH function menu. The oscilloscope provides addition, subtraction, multiplication, FFT, differential, integral and square root operations.

Ref : press the button to enter the REF function menu. A reference waveform can be displayed and compared against other waveforms.

Digital : Press the button to open the digital channel function menu (Optional function). This option is not available on the T3DSO1102.

Trigger

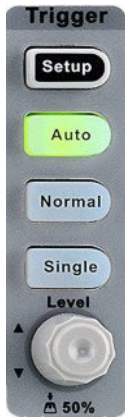

T3DSO1102 scope



All scopes except
T3DSO1102



: press the button to enter the TRIGGER function menu. The oscilloscope provides abundant advanced trigger functions

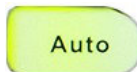

: press the button to set the trigger mode to Auto.

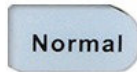

: press the button to set the trigger mode to Normal.

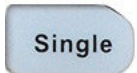

: press the button to set the trigger mode to Single.



Trigger Level Knob : adjust the trigger level. Turn clockwise to increase the level and turn counterclockwise to reduce the level. During the modification, the trigger level line would move up and down and the value in the trigger level message box at the up-right corner of the screen would change accordingly. Press down the knob to quickly reset the trigger level to center of the waveform.

Run Control



: press this key to enable the waveform auto setting function. The oscilloscope will automatically adjust the vertical scale, horizontal time base and trigger mode according to the input signal to realize optimum waveform display.



: press the button to set the acquisition state to Run or Stop.
In RUN state, the key is illuminated in yellow.
In STOP state, the key is illuminated in red.

Universal Knob

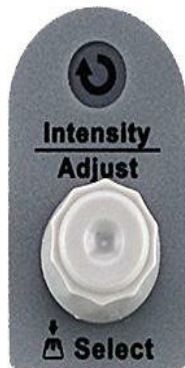

1. Adjust the waveform intensity.

You can press the **Display/Persist** button; press the **Next Page** softkey to go to the second page of the DISPLAY function menu; press the **Intensity** softkey and then turn the **Universal Knob** to adjust the waveform intensity.

2. Select the desired submenu.

In menu operation, press any menu softkey and turn the **Universal Knob** to select the desired submenu under the menu and push down the knob to confirm the current submenu. Turn clockwise to move up the submenu and counterclockwise to move down.

3. Modify parameters.

After having chosen a parameter, turn the **Universal Knob** to modify the value. Turn clockwise to increase the value and counterclockwise to reduce. In addition, it can also be used to adjust scale and offset of MATH and REF.

4. Choose file or directory or input filename.

After having entered the file system, turn the **Universal Knob** to select the desired file or directory. When inputting filename, turn the **Universal Knob** to select the desired character and then push the knob to confirm.





Menu



T3DSO1102 scope common function panel

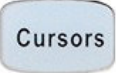
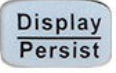
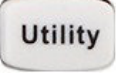

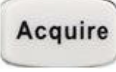
All scopes except T3DSO1102 common function panel

-  : Press the button to enter the CURSOR function menu. The oscilloscope provides manual and track cursor mode.
-  : Press the button to enter the DISPLAY function menu and quickly enable the persist function. User can set the grid, intensity, graticule, transparency.
-  : Press the button to enter the UTILITY function menu to look at the system status, do self calibration, set the sound, language and so on.
-  : The button is a shortcut key for clear function. When the measurement statistics is ON, press the button to clear the count and recount it. When persist is enabled, press the button to clear persist.
-  : Press the button to enter the MEASURE function menu to set the measurement parameters, all measurements, statistics and set the gate.
-  : Press the button to enter the ACQUIRE function menu to set the acquisition mode, memory depth, wave interpolation and so on.
-  : Press the button to enter the SAVE/RECALL function menu to save setups, waveforms, pictures, or CSV files to internal memory or USB flash driver.



: Press the button to reset the oscilloscope to user default setup.



: Press the button to enter the history mode. In history mode, it can record up to 80,000 waveforms. If the sequence function is enabled, it will only record the waveforms which you set, the maximum you can set is 80,000.



: Press the button to enter the DECODE function menu. The oscilloscope supports I2C, SPI, UART/RS232, CAN and LIN serial bus decode.



: Press the button to turn off or turn on the navigate function. The T3DSO1000 series can search events specified by the user in a frame. It can also navigate by time (delay position) and historical frames.

Search and Navigate is not available on the T3DSO1102.

Help

The oscilloscope has an online help function that supplies multi-language help information.

You can access the help function by pressing any button for 2 seconds and a help window will explain the function. Also all of the submenus include help information.

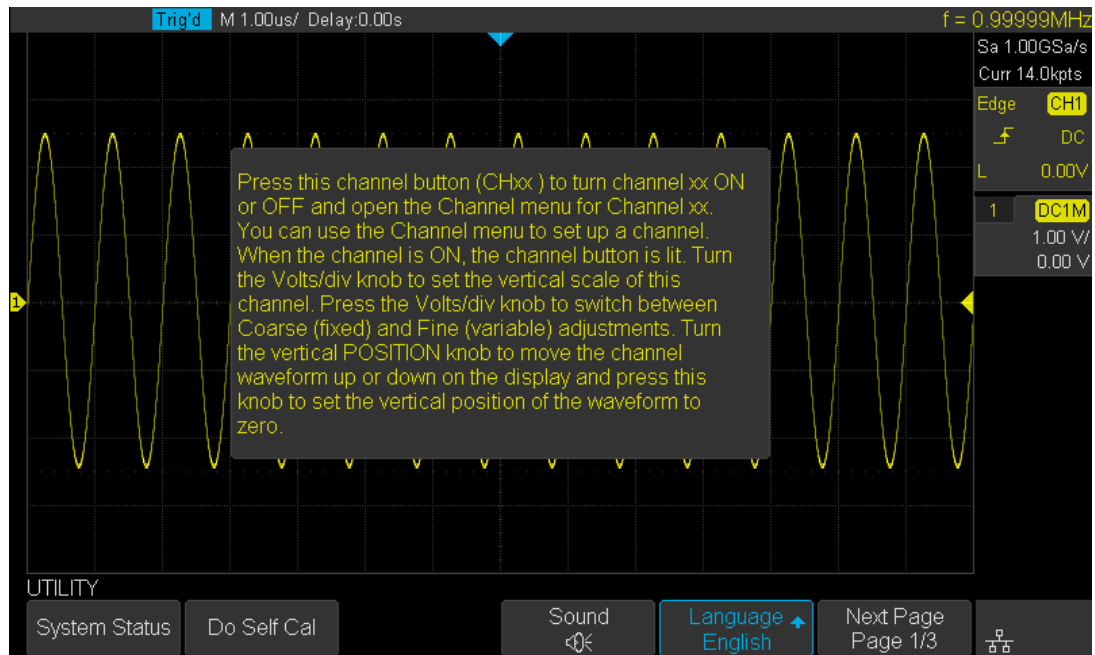

Figure 12 Help Message

User Interface

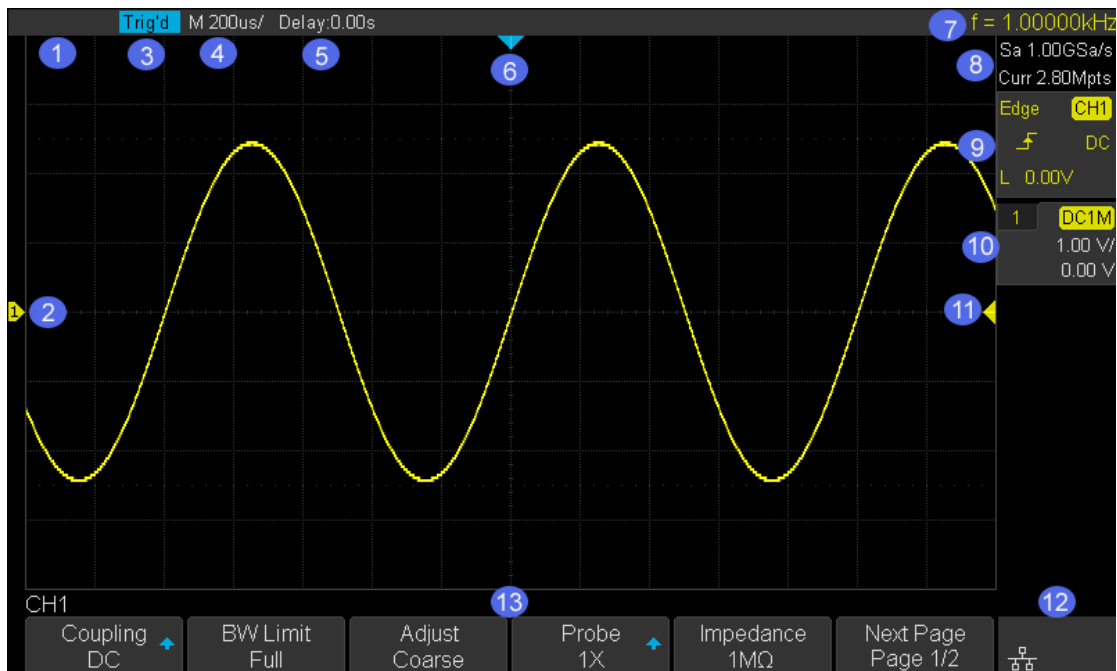

Figure 13 User Interface

1. Oscilloscope Display

The oscilloscope display is the main area to see most of the settings and the menus.

2. Channel Label/Waveform

Different channels are marked by different colors and the color of the waveform complies with the color of the channel.

3. Trigger Status

Available trigger status includes Ready, Auto, Stop, Arm, Trig'd.

4. Horizontal Time Base

- Represent the time per graticule on the horizontal axis on the screen.
- Use the **TIMEBASE Knob** to adjust the parameter. The available range is from 1.0 ns to 100 s.

5. Trigger Position

Turn the Horizontal Position Knob to adjust the delay. Push the knob to set the value to 0 (center of the screen) automatically.

6. Trigger Delay Label

Indicate the trigger zero time position on the waveform.

7. Frequency Counter

Display the frequency value of the trigger channel.

8. Sampling Rate/ Memory Depth

Display the current sampling rate and memory depth. Sa means the current sampling rate per second and Curr means the current memory depth.

9. Trigger Setup

Trigger Type  : display the current trigger type. The trigger type names display an abbreviation when the name is too long to display.

Trigger source  : displays the currently trigger source. Each channel displays in a different color.

Trigger condition  : display the current trigger condition.

Trigger coupling  : display the current trigger coupling. Available trigger coupling mode: DC, AC, HF Reject, LF Reject.

Trigger level  : display the current value of trigger level. Push the knob to set the trigger to the 50% of the waveform amplitude automatically.

10. Channel Setup

Probe attenuation factor  : display the current probe attenuation factor of the channel. Available probe attenuation factors: 0.1X, 0.2X, 0.5X, 1X, ...through to 2000X, 5000X, 10000X.

 Input impedance: display the current input impedance of the channel. Available Input impedance : 1MΩ.

Channel coupling  : display the current channel coupling of the channel. Channel coupling that are available: DC, AC, and GND.

Vertical Scale  : display the current vertical scale of the channel per division. Turn the Vertical Scale Knob to adjust the value.

11. Trigger Level Label

Display the position of trigger level, the trigger level indicator is colored the same as the channel triggered on. It can move from +4.5div to -4.5div of the screen center.

12. I/O status

 Indicate that the USB Host is connected.

 Indicate that the LAN port is connected.

 Indicate that the LAN port is disconnected.

 Indicate that the WLAN port is connected.

 Indicate that the WLAN port is disconnected.

13. Menu

 Display the corresponding function menu of the selected button. Press the corresponding softkey to adjust the oscilloscope.

To Use the Security Lock

If needed, you can use the security lock (not supplied) to lock the oscilloscope to a fixed location. The method is as follows, align the lock with the lock hole and plug it into the lock hole vertically, turn the key clockwise to lock the oscilloscope and then pull the key out.

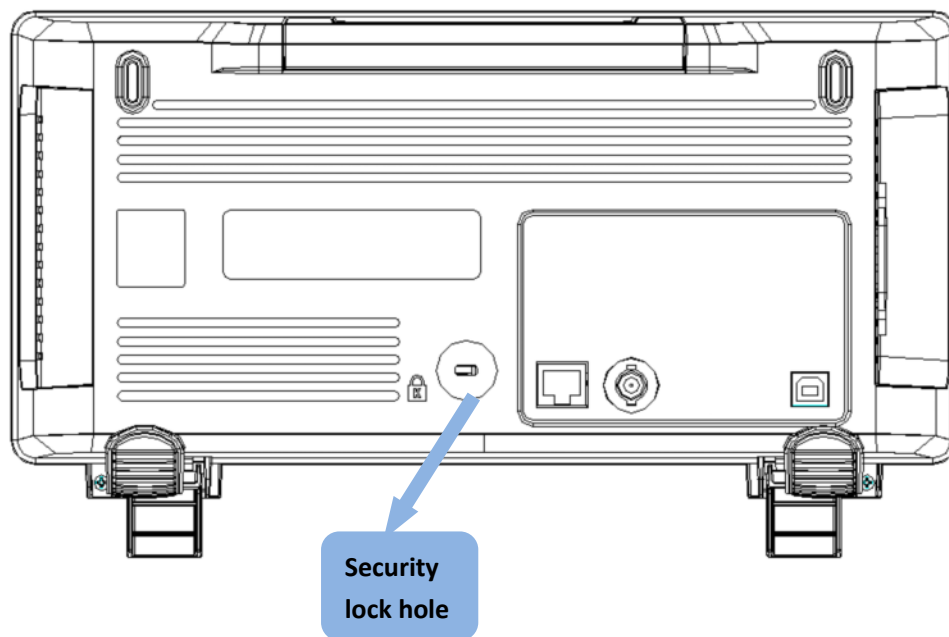

Figure 14 To Use the Security Lock

To Set the Vertical System

This chapter introduces how to set the vertical system of the oscilloscope.

The contents of this chapter:

- ◆ To Enable the Channel
- ◆ To Adjust the Vertical Scale
- ◆ To Adjust the Vertical Position
- ◆ To Specify Channel Coupling
- ◆ To Specify Bandwidth Limit
- ◆ To Specify Probe Attenuation Factor
- ◆ To Specify channel Input Impedance
- ◆ To Specify Amplitude Unit
- ◆ To Specify Deskew
- ◆ To Invert a Waveform

To Enable the Channel

The oscilloscope provides 2 or 4 analog input channels and provides independent vertical controls for each channel. This chapter takes CH1 as an example since all of the vertical channel setting methods are the same for all other channels.

Connect a signal to the CH1 channel BNC connector; and then press the **CH1** button in the vertical control area (VERTICAL) on the front panel to enable CH1 and illuminate the CH1 button.

The channel setting menu is displayed at the bottom of the screen and the channel label at the right side of the screen. The information displayed in the channel label is related to the current channel setting.

After the channel is turned on, modify the parameters such as the vertical scale, the horizontal time base and the trigger mode according to the input signal to make the waveform display easy to observe and measure.

Note: to turn off the channel, press the channel button until the channel indication light is no longer illuminated.

To Adjust the Vertical Scale

The vertical scale can be adjusted in **Coarse** or **Fine** mode.

- **Coarse** adjustment (take counterclockwise as an example): set the vertical scale in 1-2-5 steps namely 500uV/div, 1 mV/div, 2 mV/div, 5 mV/div, 10 mV/div ...10 V/div.
- **Fine** adjustment: Adjust the vertical scale within a finer adjustment range to improve vertical resolution. For example: 2 V/div, 1.98V/div, 1.96V/div, 1.94 V/div ...1 V/div.

Use: If the amplitude of the input waveform is a little greater than the display full scale under the current scale settings, and the amplitude would be too low if the next scale is used, then fine adjustment can be used to optimise the amplitude of waveform display to correctly view the signal details.

Press the **CH1** button on the front panel; then press the **Adjust** softkey to select the desired mode. Turn the **VERTICAL Variable Knob** to adjust the vertical scale (clockwise to reduce the scale and counterclockwise to increase).

The scale information in the channel label at the right side of the screen will change accordingly during the adjustment. The adjustable range of the vertical scale is related to the probe ratio currently set. By default, the probe attenuation factor is 1X and the adjustable range of the vertical scale is from 500uV/div to 10 V/div.

Note: push the **VERTICAL Variable Knob** to quickly switch between **Coarse** and **Fine** adjustments.

To Adjust the Vertical Position

Turn the **VERTICAL Position Knob** to adjust the vertical position of the channel waveform. Turn the knob clockwise to increase the vertical position and the channel waveform moves up while counterclockwise to reduce the vertical position and the waveform moves down. Push the knob to set the vertical position of the channel waveform to zero.

During the adjustment, the vertical position information Volts Pos displays at the bottom of the screen. The table below shows the range of vertical position according to the volt scale.

Volt Scale	Range of Vertical Position
500 μ V/div - 100 mV/div	± 2 V
102 mV/div - 1 V/div	± 20 V
1.02 V/div - 10 V/div	± 200 V

To Specify Channel Coupling

Set the coupling mode to filter out the undesired signals. For example, the signal under test is a square waveform with DC offset.

- When the coupling mode set to **DC**: the DC and AC components of the signal under test can both pass into the scope measurement channel.
- When the coupling mode set to **AC**: the DC components of the signal under test are blocked.
- When the coupling mode set to **GND**: the DC and AC components of the signal under test are both blocked.

Press the **CH1** button on the front panel; then press the **Coupling** softkey and turn the **Universal Knob** to select the desired coupling mode. The default setup is **DC**.

The current coupling mode is displayed in the channel label at the right side of the screen. You can also press the **Coupling** softkey continuously to switch the coupling mode.

To Specify Bandwidth Limit

Set the bandwidth limit to reduce display noise. For example, the signal under test is a pulse with high frequency oscillation.

- When the bandwidth limit set to **Full**, the high frequency components of the signal under test can pass into the scope measurement channel.
- When the bandwidth limit set to **20M**, the high frequency components that exceed 20 MHz are attenuated.

Press the **CH1** button on the front panel; then press the **BW Limit** softkey to select **Full** or **20M**. The default setup is **Full**. When bandwidth limit is enabled, the character **B** will be displayed in the channel label at the right side of the screen.

T3DSO1000 series has full BW at all V/div settings including 500uV/div to 2mV/div.

To Specify Probe Attenuation Factor

Set the probe attenuation factor to match the type of the probe that you are using to ensure correct vertical readouts.

Press the **CH1** button on the front panel; then press the **Probe** softkey and turn the **Universal Knob** to select the desired value and push the knob to confirm. The default setup is **1X**.

The current probe attenuation factor is displayed in the channel label at the right side of the screen. You can also press the **Probe** softkey continuously to switch the probe attenuation factor.

The table shows the probe attenuation factor

Menu	Attenuation Factor
0.1X	0.1 : 1
0.2X	0.2 : 1
0.5X	0.5 : 1
1X	1 : 1
2X	2 : 1
...	...
5000X	5000 : 1
10000X	10000 : 1

To Specify channel Input Impedance

The channel input impedance is $1M\Omega$.

- Impedance setting to $1M\Omega$ is for use with many passive probes and for general-purpose measurements. The higher impedance minimizes the loading effect of the oscilloscope on the device under test.

The current channel input impedance is displayed in the channel label at the right side of the screen.

To Specify Amplitude Unit

Select the amplitude display unit for the current channel. The available units are **V** and **A**. When the unit is changed, the unit displayed in the channel label will change accordingly.

1. Press **CH1** button on the front panel to enter the CH1 function menu.
2. Press the **Next Page** softkey to enter the second page of the CH1 function menu.
3. Press the **Unit** softkey to select the desired unit **V** or **A**.

The default setup is **V**.

To Specify Deskew

The valid range of each analog channel is $\pm 100\text{ns}$.

1. Press **CH1** button on the front panel to enter the CH1 function menu.
2. Press the **Next Page** softkey to enter the second page of the CH1 function menu.
3. Press the **Deskew** softkey. Then turn the **Universal Knob** to change deskew.

To Invert a Waveform

When **Invert** is set to **On**, the voltage values of the displayed waveform are inverted. Invert affects how a channel is displayed but keeps the original trigger settings.

Inverting a channel also changes the result of any math function selected and measure function.

1. Press **CH1** button on the front panel to enter the CH1 function menu.
2. Press the **Next Page** softkey to enter the second page of the CH1 function menu.
3. Press the **Invert** softkey to turn on or off the invert display.

Set the Horizontal System

This chapter introduces how to set the horizontal system of the oscilloscope.

The contents of this chapter:

- ◆ Adjust the Horizontal Scale
- ◆ Adjust the Trigger Delay
- ◆ Set Roll Mode
- ◆ Use the Zoom Function

Adjust the Horizontal Scale

Turn the **HORIZONTAL Scale Knob** on the front panel to adjust the horizontal time base. Turn clockwise to reduce the horizontal time base and turn counterclockwise to increase.

The time base information at the upper left corner of the screen will change accordingly during the adjustment. The range of the horizontal scale is from 1ns/div to 100s/div.

The Horizontal Scale Knob works (in the Normal time mode) while acquisitions are running or when they are stopped. When in run mode, adjusting the horizontal scale knob changes the sample rate. When stopped, adjusting the horizontal scale knob lets you zoom into acquired data.

Adjust Trigger Delay

Turn the Position Knob on the front panel to adjust the trigger delay of the waveform. During the modification, waveforms of all the channels would move left or right and the trigger delay message at the upper-right corner of the screen would change accordingly. Press down this knob to quickly reset the trigger delay to the center of the screen.

Changing the delay time moves the trigger point (solid inverted triangle) horizontally and indicates how far it is from the time reference point. These reference points are indicated along the top of the display grid.

All events displayed left of the trigger point happened before the trigger occurred. These events are called pre- trigger information, and they show events that led up to the trigger point.

Everything to the right of the trigger point is called post- trigger information. The amount of delay range (pre- trigger and post- trigger information) available depends on the time/div selected and memory depth.

The position knob works (in the Normal time mode) while acquisitions are running or when they are stopped.

Set the Roll mode

Press the **Roll** button to enter the roll mode.

In Roll mode the waveform moves slowly across the screen from right to left. It only operates on time base settings of 50 ms/div and slower. If the current time base setting is faster than the 50 ms/div limit, it will be set to 50 ms/div when Roll mode is entered.

In Roll mode there is no trigger. The fixed reference point on the screen is the right edge of the screen and refers to the current moment in time. Events that have occurred are scrolled to the left of the reference point. Since there is no trigger, no pre-trigger information is available.

If you would like to stop the display in Roll mode, press the **Run/Stop** button. To clear the display and restart an acquisition in Roll mode, press the **Run/Stop** button again.

Use Roll mode on low- frequency waveforms to yield a display much like a strip chart recorder. It allows the waveform to roll across the display.

Use the Zoom Function

Zoom is a horizontally expanded version of the normal display. You can use Zoom to locate and horizontally expand part of the normal window for a more detailed (higher-resolution) analysis of signals.

Press the **HORIZONTAL Scale Knob** on the front panel to turn on the zoom function, and press the button again to turn off the function. When Zoom function is on, the display divides in half. The top half of the display shows the normal time base window and the bottom half displays a faster Zoom time base window.

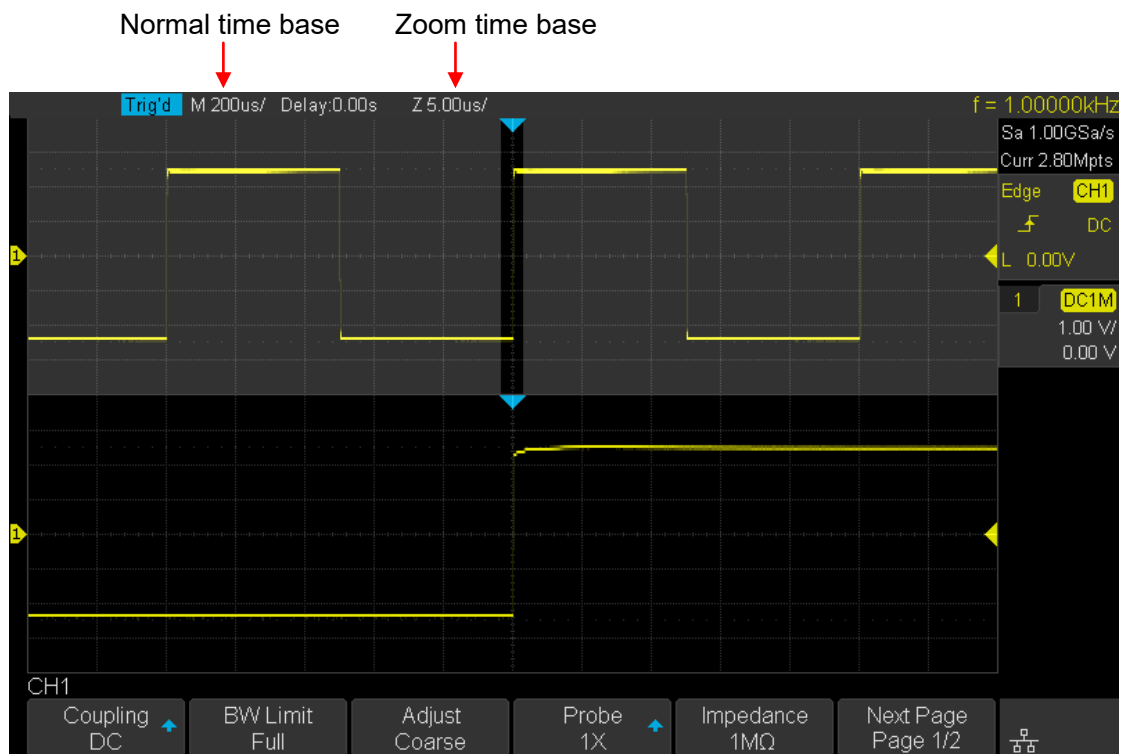

The area of the normal display that is expanded is outlined with a box and the rest of the normal display has a grey mask. The box shows the portion of the normal sweep that is expanded in the lower half.

To change the time base for the Zoom window, turn the **Horizontal Scale Knob**. The **Horizontal Scale Knob** controls the size of the box. The **Horizontal Position Knob** sets the left-to-right position of the zoom window. The delay value, which is the time displayed relative to the trigger point is momentarily displayed in the upper-right corner of the display when the **Horizontal Position Knob** is turned. Negative delay values indicate you're looking at a portion of the waveform before the trigger event, and positive values indicate you're looking at the waveform after the trigger event.

To change the time base of the normal window, turn off Zoom; then, turn the **Horizontal Scale Knob**.

To Set the Sampling System

This chapter introduces how to use the run control and set the sampling system of the oscilloscope.

The contents of this chapter:

- ◆ Run Control
- ◆ Overview of Sampling
- ◆ To Specify Memory Depth
- ◆ To Select Sampling Mode
- ◆ Waveform Interpolation Method

Run Control

Press the **Run/Stop** or **Single** button on the front panel to run or stop the sampling system of the scope.

- When the **Run/Stop** is green, the oscilloscope is running, that is, acquiring data when trigger conditions are met. To stop acquiring data, press the **Run/Stop** button. When stopped, the last acquired waveform is displayed.
- When the **Run/Stop** button is red, data acquisition is stopped. Red "Stop" is displayed in the status line at the top of the display. To start acquiring data, press **Run/Stop**.
- To capture and display a single acquisition (whether the oscilloscope is running or stopped), press **Single**. The **Single** run control lets you view single-shot events without subsequent waveform data overwriting the display. Use **Single** when you want maximum memory depth for pan and zoom.

When you press **Single**, the display is cleared, the trigger mode is temporarily set to Normal (to keep the oscilloscope from auto-triggering immediately), the trigger circuitry is armed, the **Single** key is illuminated, and the oscilloscope waits until a user defined trigger condition occurs before it displays a waveform.

When the oscilloscope triggers, the single acquisition is displayed and the oscilloscope is stopped (the **Run/Stop** button is illuminated in red).

Press **Single** again to acquire another waveform

Overview of Sampling

To understand the oscilloscope's sampling and acquisition modes, it is helpful to understand sampling theory, sample rate and oscilloscope bandwidth and sample rate.

Sampling Theory

The Nyquist sampling theorem states that for a limited bandwidth (band - limited) signal with maximum frequency f_{MAX} , the equally spaced sampling frequency f_S must be greater than twice the maximum frequency f_{MAX} , in order for the signal to be uniquely reconstructed without aliasing.

$f_{MAX} = f_{S/2} = \text{Nyquist frequency } (f_N) = \text{folding frequency}$

Sample Rate

The maximum sample rate of the oscilloscope is 2GSa/s. The actual sample rate of the oscilloscope is determined by the horizontal scale. Turn the **Horizontal Scale Knob** to adjust the sample rate.

The actual sample rate is displayed in the information area at the upper-right corner of the screen.

The influence on the waveform when the sample rate is too low:

1. **Waveform Distortion:** when the sample rate is too low, some waveform details are lost and the waveform displayed is rather different from the actual signal.

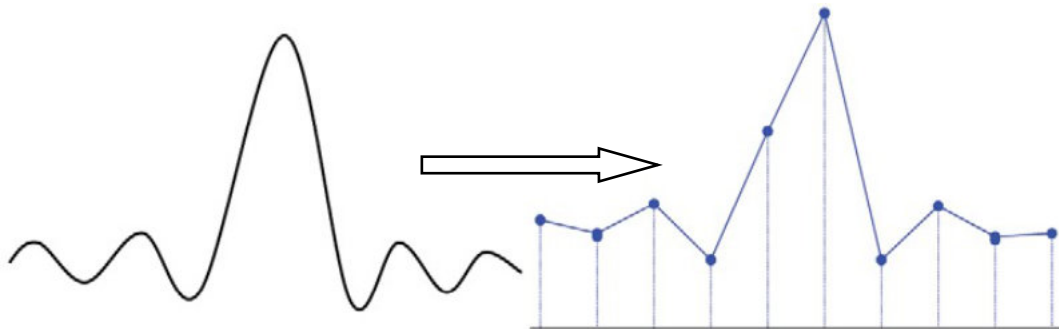

2. **Waveform Aliasing:** when the sample rate is lower than twice the actual signal frequency (Nyquist Frequency), the frequency of the waveform rebuilt from the sample data is lower than the actual signal frequency. The most common aliasing is the jitter on a fast edge.

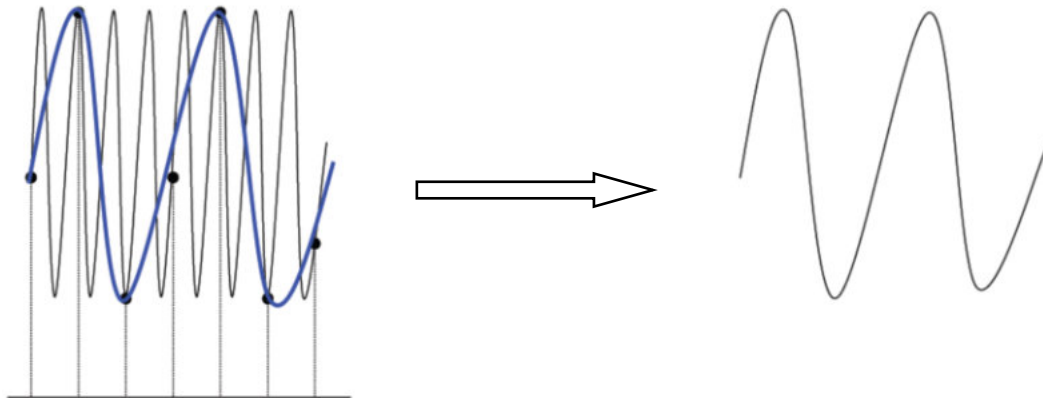

3. **Waveform Leakage:** when the sample rate is too low, the waveform rebuilt from the sample data does not reflect all the actual signal information.

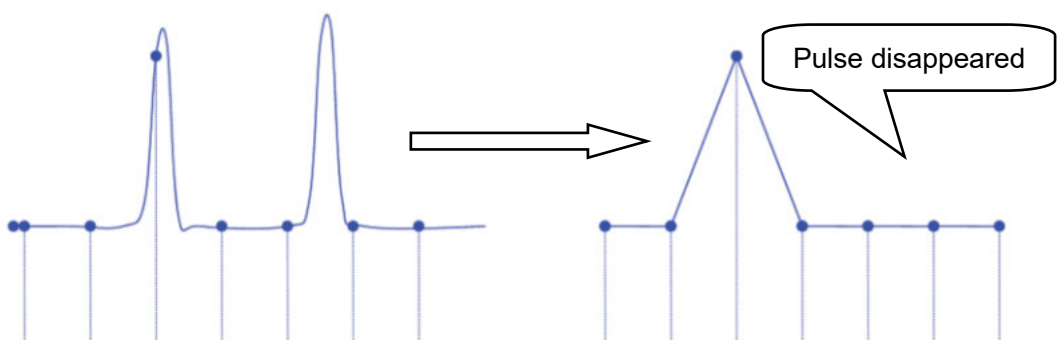

Oscilloscope Bandwidth and Sample Rate

An oscilloscope's bandwidth is typically described as the lowest frequency at which input signal sine waves are attenuated by 3 dB (- 30% amplitude error).

At the oscilloscope bandwidth, sampling theory says the required sample rate is $f_s = 2f_{BW}$. However, the theory assumes there are no frequency components above f_{MAX} (f_{BW} in this case) and it requires a system with an ideal brick-wall frequency response.

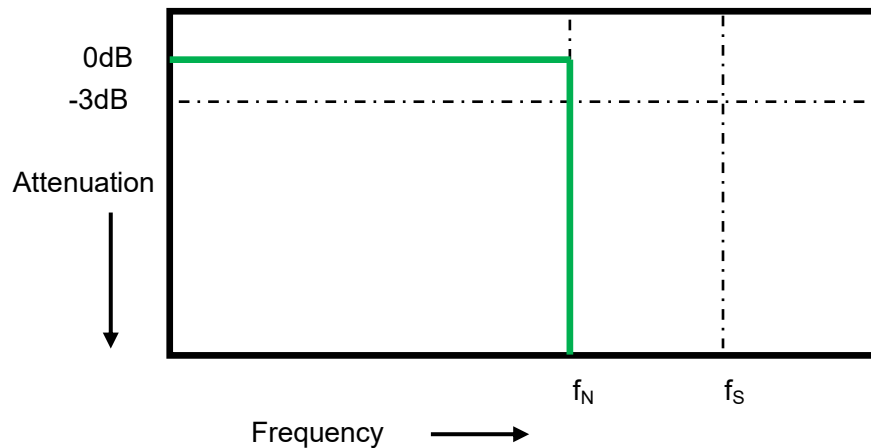

However, digital signals have frequency components above the fundamental frequency (square waves are made up of sine waves at the fundamental frequency and an infinite number of odd harmonics), and typically, for 500 MHz bandwidths and below, oscilloscopes have a Gaussian frequency response.

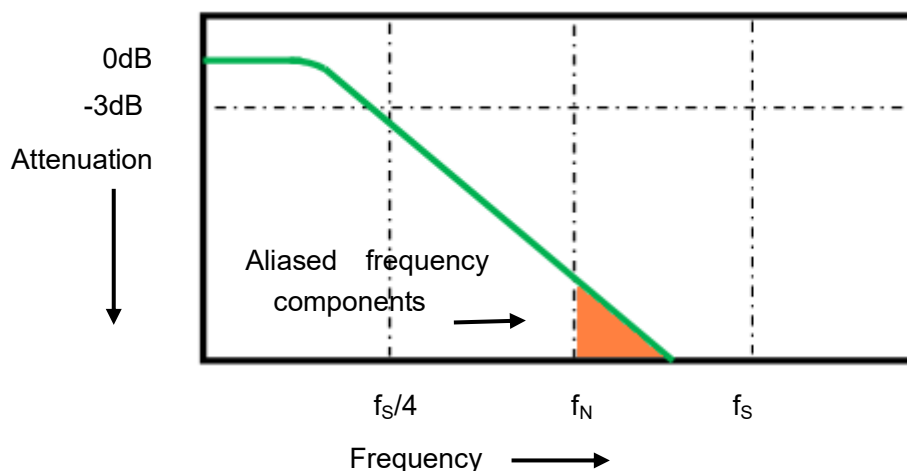

Limiting oscilloscope bandwidth (f_{BW}) to 1/4 the sample rate ($f_s/4$) reduces frequency components above the Nyquist frequency (f_N).

So, in practice, an oscilloscope's sample rate should be four or more times its bandwidth: $f_s = 4f_{BW}$. This way, there is less aliasing, and aliased frequency components have a greater amount of attenuation.

Select Memory Depth

Memory depth refers to the number of waveform points that the oscilloscope can store in a single trigger sample and it reflects the storage ability of the sample memory. The oscilloscope provides up to 14 Mpts memory depth.

Press the **Acquire** button on the front panel; press the **Mem Depth** softkey and then turn the **Universal Knob** to select the desired value and push down the knob to confirm. Press the **Mem Depth** softkey continually can also select the desired value.

The actual memory depth is displayed in the information area at the upper- right corner of the screen. Memory depths that are available: 14K, 140K, 1.4M, 14M.

Since the oscilloscope has two acquisition memories, when only one channel is on, the maximal memory depth is up to 14 Mpts.

The relation of memory depth, sample rate and waveform length fulfils the equation below:

Memory depth = sample rate (Sa/s) × waveform length (s/div × div)

Select Sampling Mode

The oscilloscope only supports real-time sampling. In this mode, the oscilloscope samples and displays a waveform within a trigger event. The maximum real-time sample rate is 1GSa/s.

Press the **RUN/STOP** button to stop the sampling, the oscilloscope will hold the last display. At this point, you can still use the vertical control and horizontal control to pan and zoom the waveform.

Select Waveform Interpolation Method

Under real-time sampling, the oscilloscope acquires the discrete sample values of the waveform being displayed. In general, a waveform of dots display type is very difficult to observe. In order to increase the visibility of the signal, the digital oscilloscope usually uses the interpolation method to display a waveform.

Interpolation method is a processing method to “connect all the sampling points”, and uses the points to calculate the whole appearance of the waveform. For real-time Sampling, interpolation method is used, even if the oscilloscope is in a single capture mode and only a small number of sampling points are captured. The oscilloscope can use interpolation for filling in the gaps between points to reconstruct an accurate waveform.

Press the **Acquire** button on the front panel to enter the ACQUIRE Function menu; then press the **Interpolation** softkey to select **Sinx/x** or **X**.

- **X**: The adjacent sample points are directly connected with a straight line. This method is only used to rebuild on the fast edge of signals, such as a square wave.
- **Sinx/x**: Connecting the sampling points with curves has greater versatility. Sinx/x interpolation method uses mathematical processing to calculation results in between the actual sample points. This method smooths the signal waveform, and gives it a more realistic regular shape than straight line connected sample points. When the sampling rate is relatively low, less than 5 times the bandwidth of the highest frequency of the waveform, it is recommended to use the Sinx/s interpolation method.



Figure 15 Display Type Set to Dots

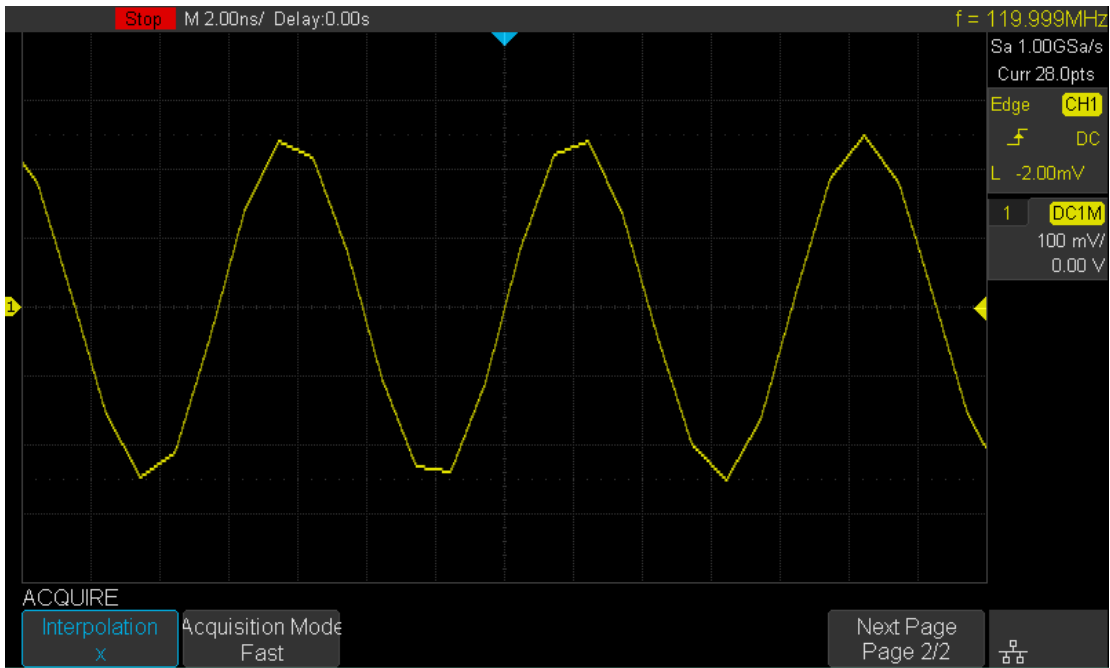

Figure 16 x Interpolation

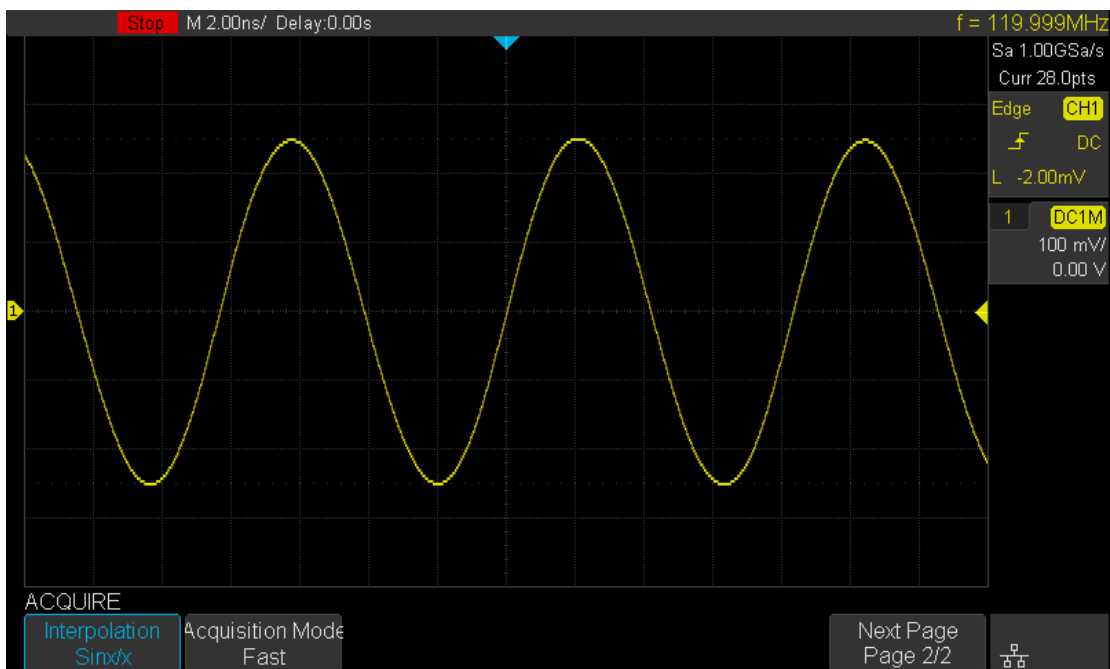

Figure 17 Sinx/x Interpolation

Select Acquisition Mode

The acquisition mode is used to control how to generate waveform points from sample points. The oscilloscope provides the following acquisition mode: Normal, Peak Detect, Average and High Resolution.

1. Press the **Acquire** button on the front panel to enter the ACQUIRE function menu;
2. Press the **Acquisition** softkey; then turn the **Universal Knob** to select the desired acquisition mode and push down the knob to confirm. The default setup is **Normal**.

Normal

In this mode, the oscilloscope samples the signal at equal time interval to rebuild the waveform. For most of the waveforms, the best display effect can be obtained using this mode. It is the default acquisition mode.

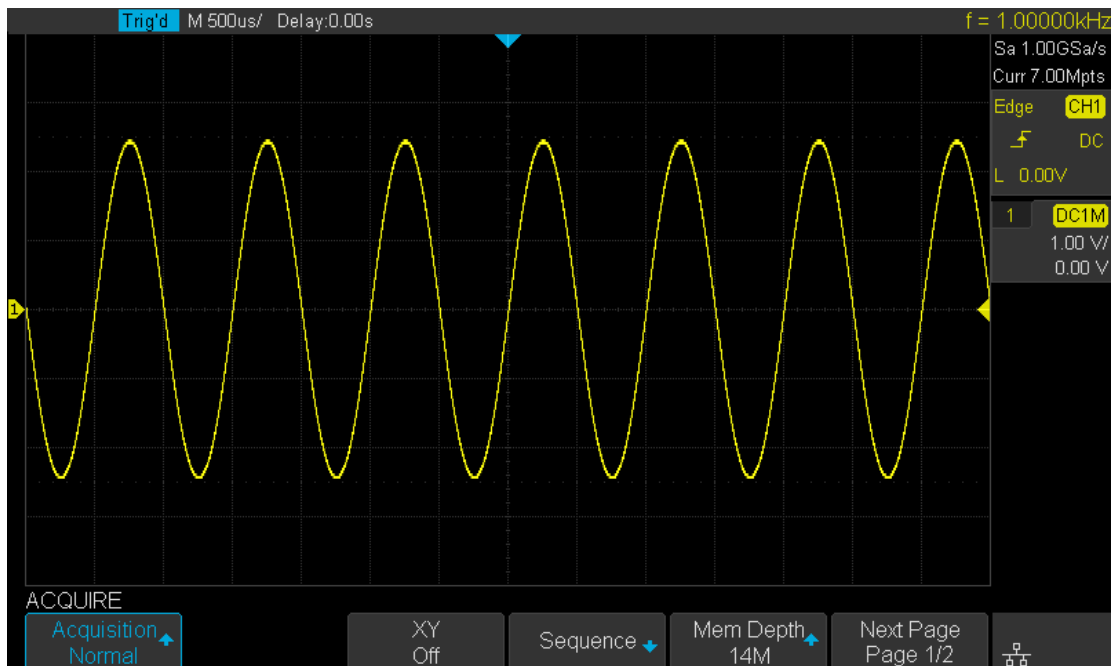

Figure 18 Acquisition System

Peak Detect

In this mode, the oscilloscope acquires the maximum and minimum values of the signal within the sample interval to get the envelope of the signal or the narrow pulse of the signal that might be lost. In this mode, signal loss can be prevented but displayed noise will increase.

In this mode, the oscilloscope can display all the pulses with pulse widths at least as wide as the sample period.

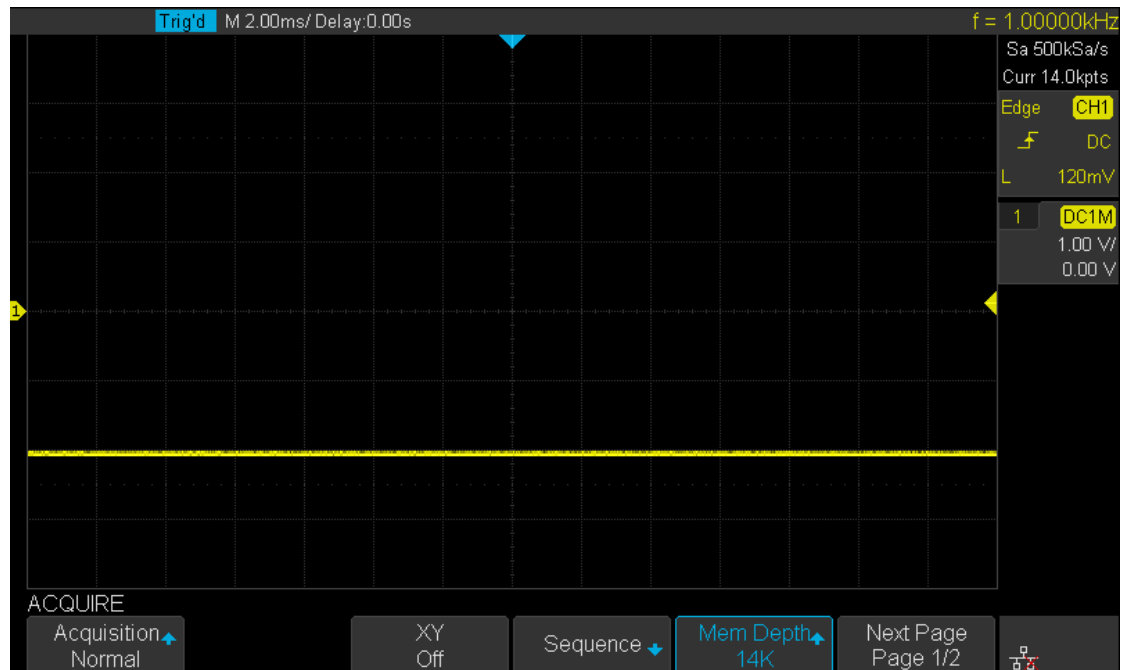

Figure 19 Pulse With 0.1% Duty, Normal Mode



Figure 20 Pulse With 0.1% Duty, Peak Detect Mode

Average

In this mode, the oscilloscope averages the waveforms from multiple acquisitions to reduce the random noise of the input signal and improve the vertical resolution. The greater the number of averages, the lower the noise will be, and the higher the vertical resolution will be, but the slower the response of the displayed waveform to waveform changes.

The available range of averages is from 4 to 1024 and the default is 16. When Average mode is selected, press **Averages** and turn the universal knob or press the softkey continually to set the desired average time.

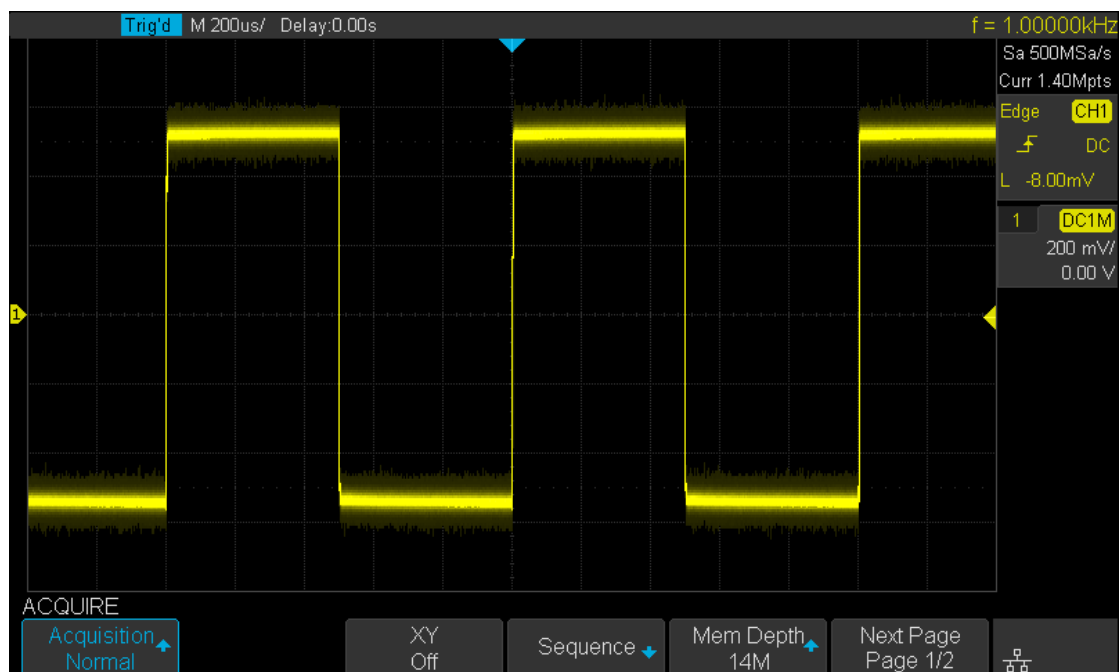

Figure 21 With Random Noise, Normal Mode

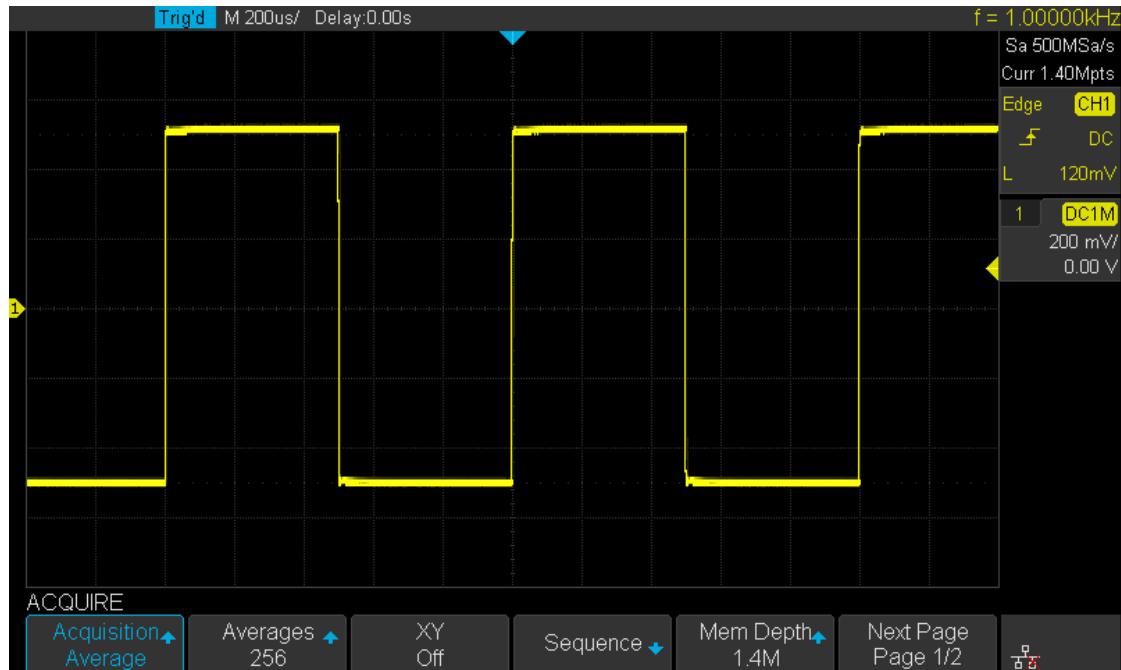

Figure 22 With Random Noise, Average Mode

High Resolution

This mode uses a linear averaging technique to average the neighbouring points of the sample waveform to reduce the random noise on the input signal and generate much smoother waveforms on the screen.

High Resolution mode can be used on both single shot and repetitive signals, and it does not slow waveform update. This mode limits the oscilloscope's real time bandwidth because it effectively acts like a low pass filter.

Note: "Average" and "High Res" modes use different averaging methods. The former uses "Waveform Average" and the latter uses "Linear Average".

Change the Horizontal Format

Press the **Acquire** button on the front panel; then press the **XY** soft key to set the XY(On) or YT(Off) mode. The default setup is **YT**.

YT

It is the normal viewing mode for the oscilloscope. In the Normal time mode, signal events occurring before the trigger are shown to the left of the trigger point and signal events after the trigger point are displayed to the right of the trigger point.

XY

XY mode changes the display from a volt- versus- time display to a volt- versus- volt display. Channel 1 amplitude is plotted on the X- axis and Channel 2 amplitude is plotted on the Y- axis, the two channels will be turned on or off together.

You can use XY mode to compare frequency and phase relationships between two signals. XY mode can also be used with transducers to display strain versus displacement, flow versus pressure, volts versus current, or voltage versus frequency.

The phase deviation between two signals with the same frequency can be easily measured via Lissajous method. The figure below shows the measurement schematic diagram of the phase deviation.

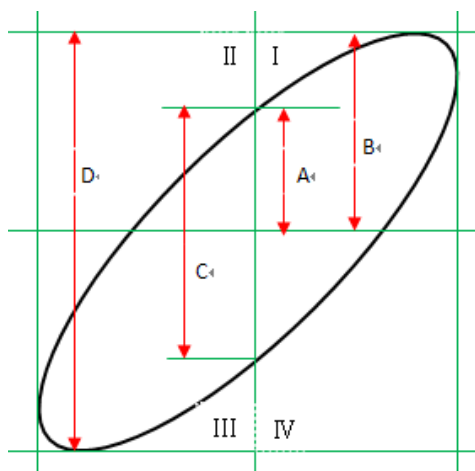

According to $\sin\theta=A/B$ or C/D (wherein, θ is the phase deviation angle between the two channels and the definitions of A, B, C and D are as shown in the figure above), the phase deviation angle is obtained, that is: $\theta=\pm\arcsin (A/B)$ or $\pm\arcsin (C/D)$

If the principal axis of the ellipse is within quadrant I and III, the phase deviation angle obtained should be within quadrant I and IV, namely within $(0$ to $\pi/2)$ or $(3\pi/2$ to $2\pi)$. If the principal axis of the ellipse is within quadrant II and IV, the phase deviation angle obtained should be within quadrant II and III, namely within $(\pi/2$ to $\pi)$ or $(\pi$ to $3\pi/2)$.

X-Y function can be used to measure the phase deviation occurred when the signal under test passes through a circuit network. Connect the oscilloscope to the circuit to monitor the input and output signals of the circuit.

Use Sequence Mode

Sequence is also an acquisition mode, which does not display a waveform during the sampling process. This improves the waveform capture rate, to a maximal capture rate of 400,000 wfs/s. So it can capture the small probability events effectively. The oscilloscope runs and fills a memory segment for each trigger event. The oscilloscope screen is not updated whilst the oscilloscope is busy acquiring multiple segments. The oscilloscope continues to trigger until memory is filled, and then displays the waveforms on the screen. To use the sequence mode, the HORIZONTAL Format must be set to **YT**.

Do the following steps to use the sequence mode.

1. Press the **Acquire** button on the front panel to enter the ACQUIRE function menu.
2. Press the **Sequence** softkey to enter the SEQUENCE function menu.

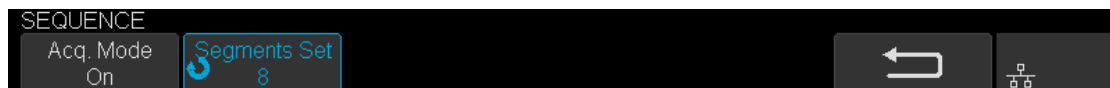

Figure 23 SEQUENCE Function Menu

3. Press the **Segments Set** softkey; and then turn the **Universal Knob** to select the desired value.

Do the following steps to replay the sequence waveform under history mode:

1. Press the **History** softkey to enable HISTORY function.

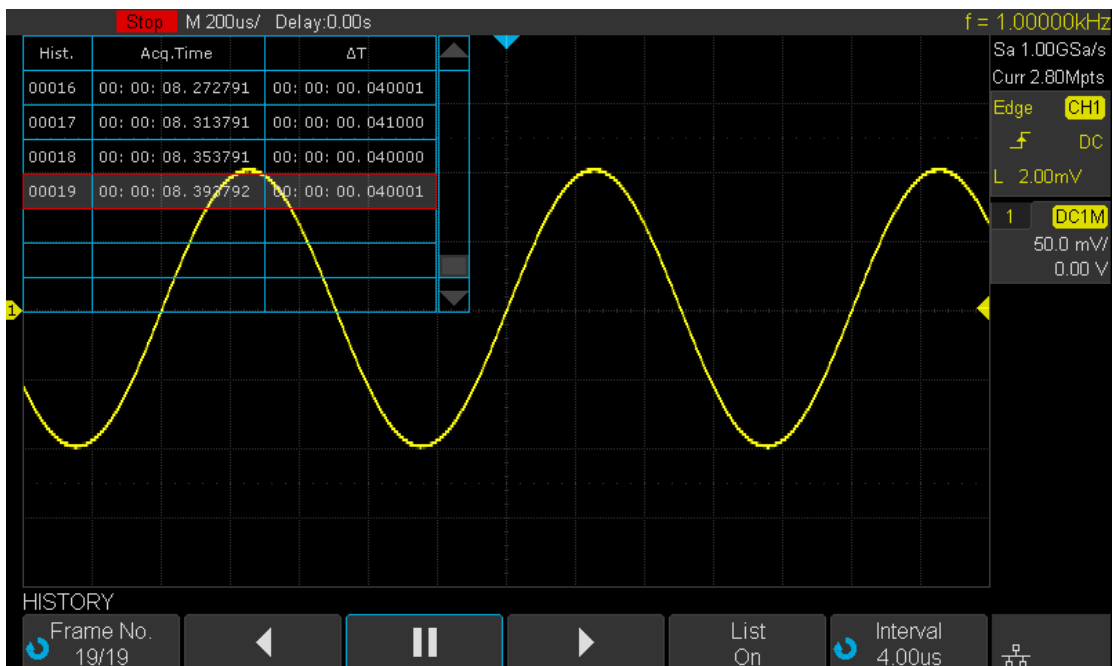





Figure 24 HISTORY Function Menu

2. Press the **List** softkey to turn on the list display. The list records the acquisition time of every frame and shows the frame number that is displaying on the screen.
3. Press the **Frame No.** softkey; and then turn the **Universal Knob** to select the frame to display.

-
4. Press the  softkey to replay the waveform from the current frame to 1.
 5. Press the  softkey to stop replay.
 6. Press the  softkey to replay the waveform from the current frame to the last frame.

To Trigger the Oscilloscope

For triggering, set your trigger conditions according to the requirements, and when a waveform in the waveform stream meets this condition, the oscilloscope captures the waveform and displays it on the screen. The trigger circuit ensures that every acquisition centers around the user-defined trigger condition.

The following is the schematic diagram of the acquisition memory. As shown in the figure below, the position of the trigger event is determined by the reference time point and the delay setting.

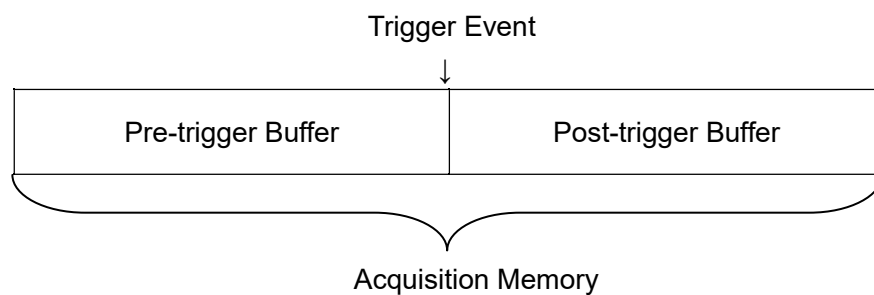

Trigger settings should be based on your requirements and the features of the input signal, thus you need to have some knowledge of the signal under test to quickly capture the desired waveform.

The oscilloscope provides numerous advanced trigger functions which can help you focus on the desired waveform details. These trigger types are edge, slope, pulse, video, window, interval, dropout, runt, pattern and serial trigger. This chapter will introduce all these trigger functions and tell you how to set the trigger conditions to capture the desired waveform.

The contents of this chapter:

- ◆ Trigger Source
- ◆ Trigger Mode
- ◆ Trigger Level
- ◆ Trigger Coupling
- ◆ Trigger Holdoff
- ◆ Noise Rejection
- ◆ Trigger Type
 - Edge Trigger
 - Slope Trigger
 - Pulse Trigger
 - Video Trigger
 - Window Trigger
 - Interval trigger
 - DropOut Trigger
 - Runt Trigger
 - Pattern Trigger

Trigger Source

The 2-channel oscilloscope's trigger source includes analog channels, **EXT**, **EXT/5** and **AC Line**.

The 4-channel oscilloscope's trigger source includes analog channels and **AC Line**.

Press the **Setup** button on the front panel to enter the TRIGGER function menu; press the **Source** softkey and then turn the **Universal Knob** to select the desired trigger source.

The current trigger source is displayed at the upper right corner of the screen. Select a channel with a signal input as the trigger source to obtain a stable trigger.

Analog channel input:

All signals from the analog channels can all be used as the trigger source, no matter whether the channel selected is enabled, or not.

External trigger input:

External trigger source can be used to connect an external trigger signal to the EXT TRIG channel if required. The trigger signal (such as an external clock or signal of the circuit to be tested) will be connected to **EXT** and **EXT/5** trigger source via the **[EXT TRIG]** connector. **EXT/5** trigger source attenuates the signal by a factor of 5. It extends the trigger voltage level.

AC line:

The trigger signal is obtained from the AC power input of the oscilloscope. These kinds of signals can be used to display the relationship between signal (such as an illuminating device) and power (power supply device). For example, it is mainly used in line frequency power related measurements.

Note: Select a stable channel waveform as the trigger source to stabilize the display.

Trigger Mode

The oscilloscope's trigger mode includes Auto, Normal and Single. The Trigger Mode affects the way in which the oscilloscope searches for the trigger.

After the oscilloscope starts running, the oscilloscope operates by first filling the pre-trigger buffer. It starts searching for a trigger after the pre-trigger buffer is filled and continues to flow data through this buffer while it searches for the trigger. While searching for the trigger, the oscilloscope overflows the pre-trigger buffer and the first data put into the buffer is first pushed out (First Input First Out, FIFO).

When a trigger is found, the pre-trigger buffer contains the events that occurred just before the trigger. Then, the oscilloscope fills the post-trigger buffer and displays the acquisition memory.

Press the **Auto**, **Normal** and the **Single** buttons on the front panel to select the desired trigger mode, and the corresponding status light will be lit.

- In the **Auto** trigger mode (the default setting), if the specified trigger conditions are not found, triggers are forced and acquisitions are made so that signal activity is displayed on the oscilloscope.

The **Auto** trigger mode is appropriate when:

- Checking DC signals or signals with unknown levels or activity.
- When trigger conditions occur often enough that forced triggers are unnecessary.

- In the **Normal** trigger mode, triggers and acquisitions only occur when the specified trigger conditions are found. Otherwise, the oscilloscope holds the original waveform and waits for the next trigger.

The **Normal** trigger mode is appropriate when:

- You only want to acquire specific events specified by the trigger settings.
- Triggering on an infrequent signal from a serial bus (for example, I2C, SPI, CAN, LIN, etc.) or another signal that arrives in bursts. The **Normal** trigger mode lets you stabilize the display by preventing the oscilloscope from auto-triggering.

- In the Single trigger mode, the oscilloscope waits for a trigger and displays the waveform when the trigger condition is met and then stops.

The **Single** trigger mode is appropriate:

- To capture single event or a periodic signal.
- To capture burst or other unusual signals.

Trigger Level

Trigger level and slope define the trigger point

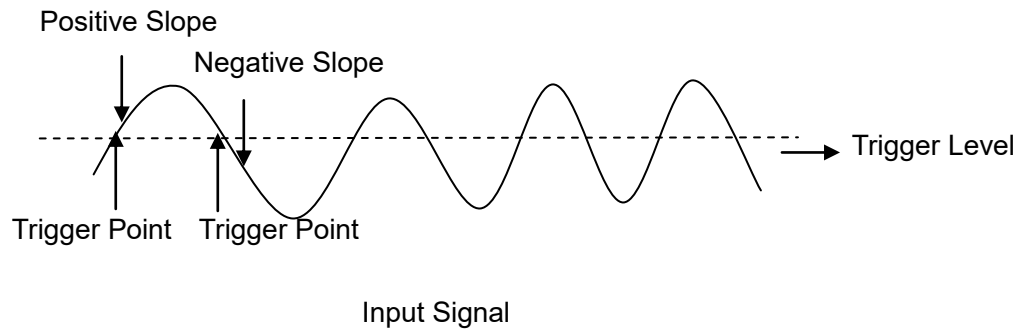

You can adjust the trigger level for a selected analog channel by turning the **Trigger Level Knob**.

You can push the **Trigger Level Knob** to set the level to 50% of the waveform's value immediately. If AC coupling is used, pushing the **Trigger Level knob** sets the trigger level to about 0 V.

The position of the trigger level for the analog channel is indicated by the trigger level icon  (if the analog channel is on) at the left side of the display. The value of the analog channel trigger level is displayed in the upper- right corner of the display.

Trigger Coupling

Press the **Setup** button on the front panel to enter the TRIGGER function menu, and then press the **Coupling** softkey and turn the **Universal Knob** or press the **Coupling** softkey continually to select the desired coupling mode.

The oscilloscope provides 4 kinds of trigger coupling modes:

- **DC**: allow DC and AC components into the trigger path.
- **AC**: block all the DC components and attenuate signals lower than 5.8 Hz. Use AC coupling to get a stable edge trigger when your waveform has a large DC offset.
- **LF Reject**: block the DC components and reject the low frequency components lower than 2.08MHz. Low frequency reject removes any unwanted low frequency components from a trigger waveform, such as power line frequencies, etc., that can interfere with proper triggering. Use **LF Reject** coupling to get a stable edge trigger when your waveform has low frequency noise.
- **HF Reject**: reject the high frequency components higher than 1.27MHz)

Note: trigger coupling has nothing to do with the channel coupling.

Trigger Holdoff

Trigger holdoff can be used to stabilize the trigger on complex waveforms (such as pulse streams or burst waveforms). Holdoff by time is the amount of time that the oscilloscope waits before re-arming the trigger circuitry. The oscilloscope will not trigger until the holdoff time expires.

Use the holdoff to trigger on repetitive waveforms that have multiple edges (or other events) between waveform repetitions. You can also use holdoff to trigger on the first edge of a burst when you know the minimum time between bursts.

For example, to get a stable trigger on the repetitive pulse burst shown below, set the holdoff time to be >200 ns but <600 ns.

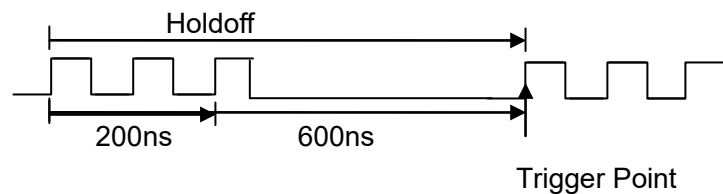

The correct holdoff setting is typically slightly less than one repetition of the waveform. Set the holdoff to this time to generate a unique trigger point for a repetitive waveform. Only edge trigger and serial trigger have holdoff option. The holdoff time of the oscilloscope is adjustable from 100ns to 1.5s.

1. Press the **Stop** button, and then use the **Horizontal Position Knob** and the **Horizontal Scale Knob** to find where the waveform repeats. Measure this time using cursors; then, set the holdoff.
2. Press the **Setup** button on the front panel to enter the TRIGGER function menu. The default trigger type is edge.
3. Press the **Holdoff Close** softkey; and then turn the **Universal Knob** to set the desired holdoff time.

Note: adjust the time scale and horizontal position will not affect the holdoff time.

Noise Rejection

Noise Reject adds additional hysteresis to the trigger circuitry. By increasing the trigger hysteresis band, you reduce the possibility of triggering on noise. However, this also decreases the trigger sensitivity so that a slightly larger signal is required to trigger the oscilloscope.

Press the **Setup** button on the front panel, and then press the **Noise Reject** softkey continually to set the option to **On** or **Off** to turn on or off the noise rejection function.

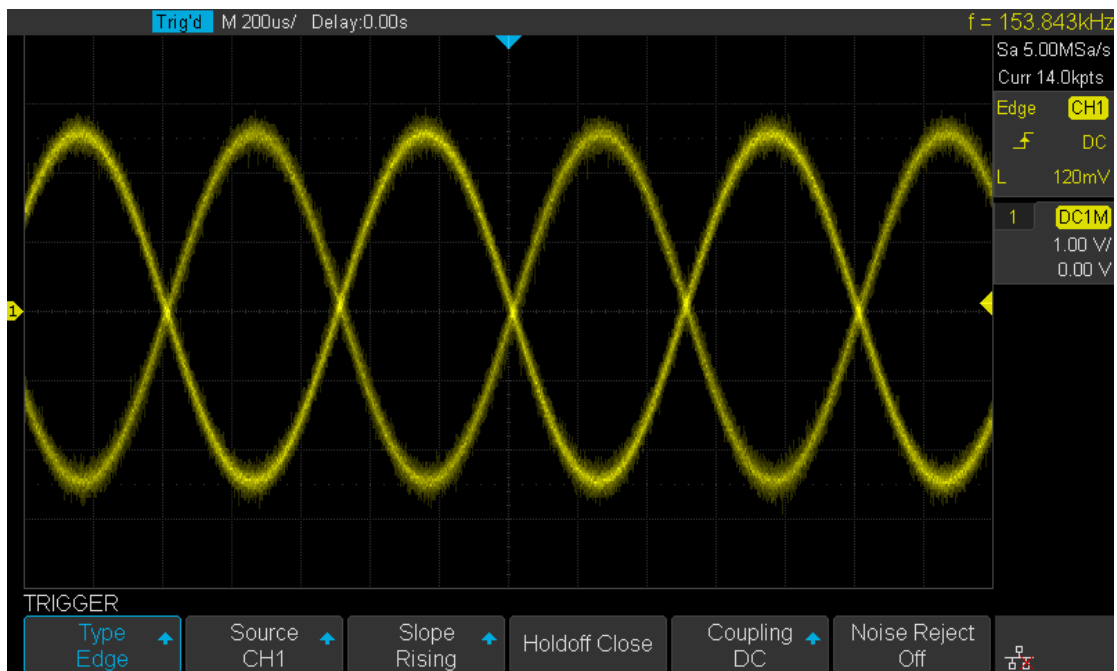

Figure 25 Turn off the Noise Reject

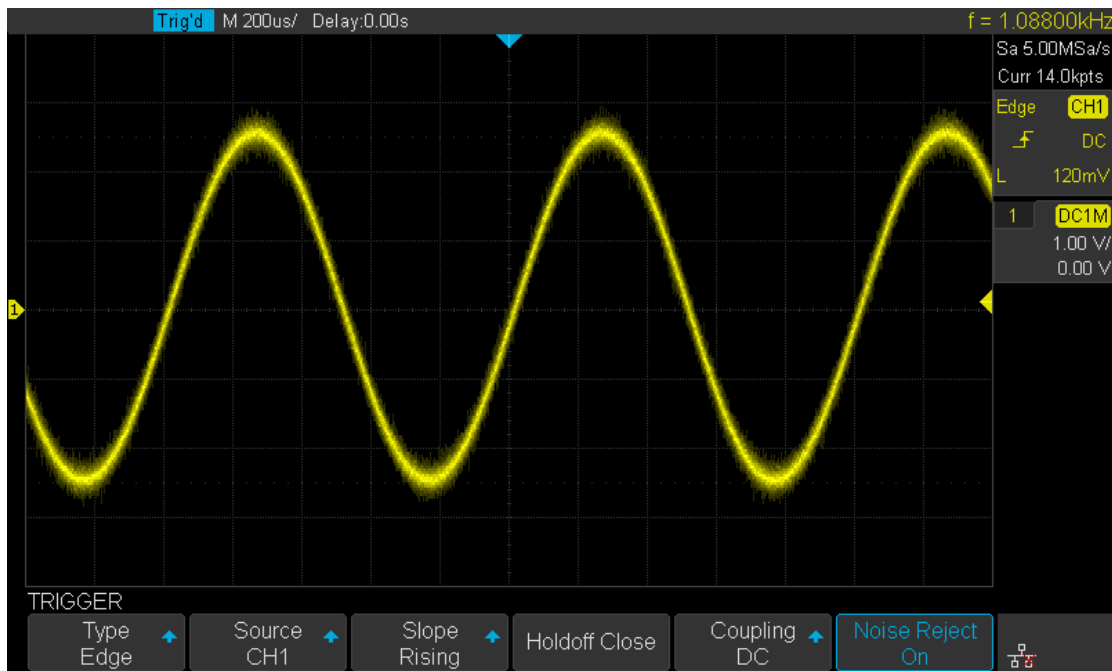

Figure 26 Turn on the Noise Reject

If the signal you are probing is noisy, you can set up the oscilloscope to reduce the noise in the trigger path and on the displayed waveform. First, stabilize the displayed waveform by removing the noise from the trigger path. Second, reduce the noise on the displayed waveform.

1. Connect a signal to the oscilloscope and obtain a stable display.
2. Remove the noise from the trigger path by setting trigger coupling to **LF Reject**, **HF Reject** or turning on **Noise Reject**.
3. Set the **Acquisition** option to Average to reduce noise on the displayed waveform.

Trigger Type

The oscilloscope provides abundant advanced trigger functions, including various serial bus triggers.

- ◆ Edge trigger
- ◆ Slope trigger
- ◆ Pulse trigger
- ◆ Video trigger
- ◆ Window trigger
- ◆ Interval trigger
- ◆ DropOut trigger
- ◆ Runt trigger
- ◆ Pattern trigger

Edge Trigger

Edge trigger distinguishes the trigger points by seeking the specified edge (rising, falling, rising & falling) and trigger level.

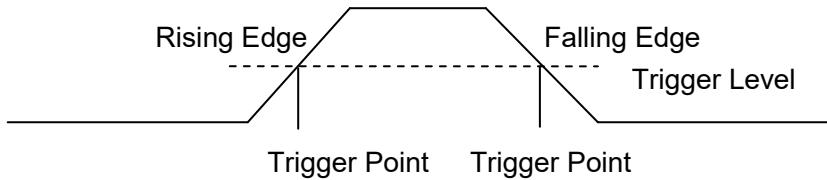

1. Press the **Setup** button on the front panel to enter the TRIGGER system function menu.
2. Press the **Type** softkey; turn the **Universal Knob** to set select **Edge** and then push the knob to confirm.
3. Press the **Source** softkey; turn the **Universal Knob** to select the desired trigger source.
4. Press the **Slope** softkey; turn the **Universal Knob** to select the desired trigger edge (rising, falling or rising & falling), and then press down the knob to confirm. The current trigger slope is displayed at the upper right corner of the screen.
5. Turn the **Trigger Level Knob** to adjust the trigger level to obtain stable trigger.

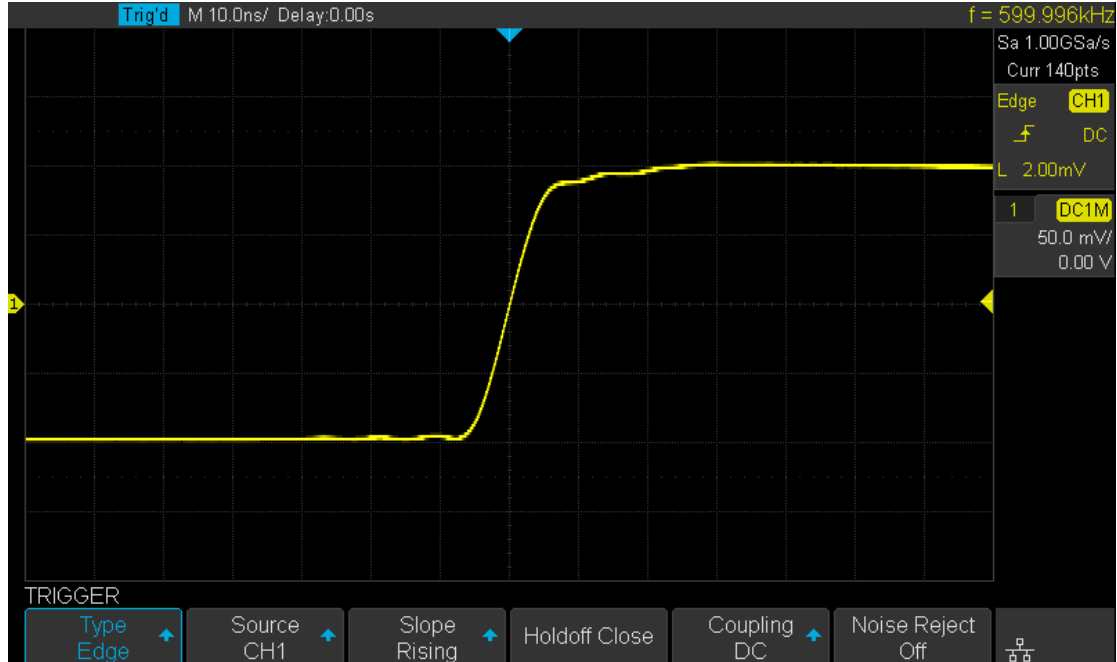

Figure 27 Edge Trigger

Note: Press the **Auto Setup** button will set the trigger type to Edge and slope to rising.

Slope Trigger

The slope trigger looks for a rising or falling transition from one level to another level in greater than or less than a certain amount of time.

In the oscilloscope, positive slope time is defined as the time difference between the two crossing points of trigger level line A and B with the positive edge as shown in the figure below.

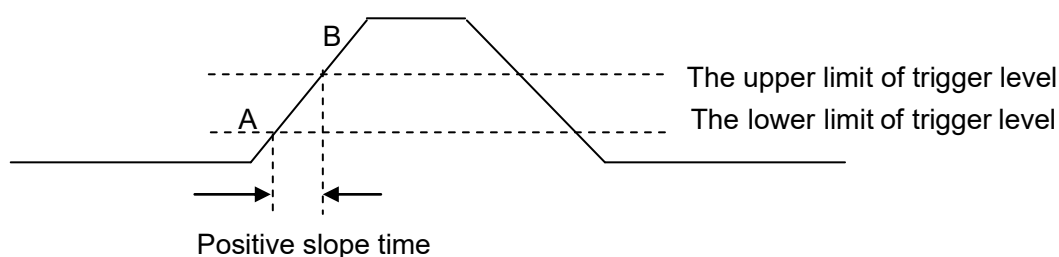

1. Press the **Setup** button on the front panel to enter the TRIGGER function menu.
2. Press the **Type** softkey; turn the **Universal Knob** to set select **Slop** and then push the knob to confirm.
3. Press the **Source** softkey; turn the **Universal Knob** to select CH1 or CH2 as the trigger source.
4. Press the Slop softkey; turn the **Universal Knob** to set select the desired trigger edge (rising or falling), and then push down the knob to confirm. The current trigger slope is displayed at the upper right corner of the screen.
5. Press **Lower Upper** softkey to select the **Lower** or **Upper** trigger level; then turn the **Trigger Level Knob** to adjust the position. The trigger level values are displayed at the upper right corner of the screen.

The lower trigger level cannot be higher than the upper trigger level. In the trigger state message box, L1 means the upper trigger lever while L2 means the lower trigger level.

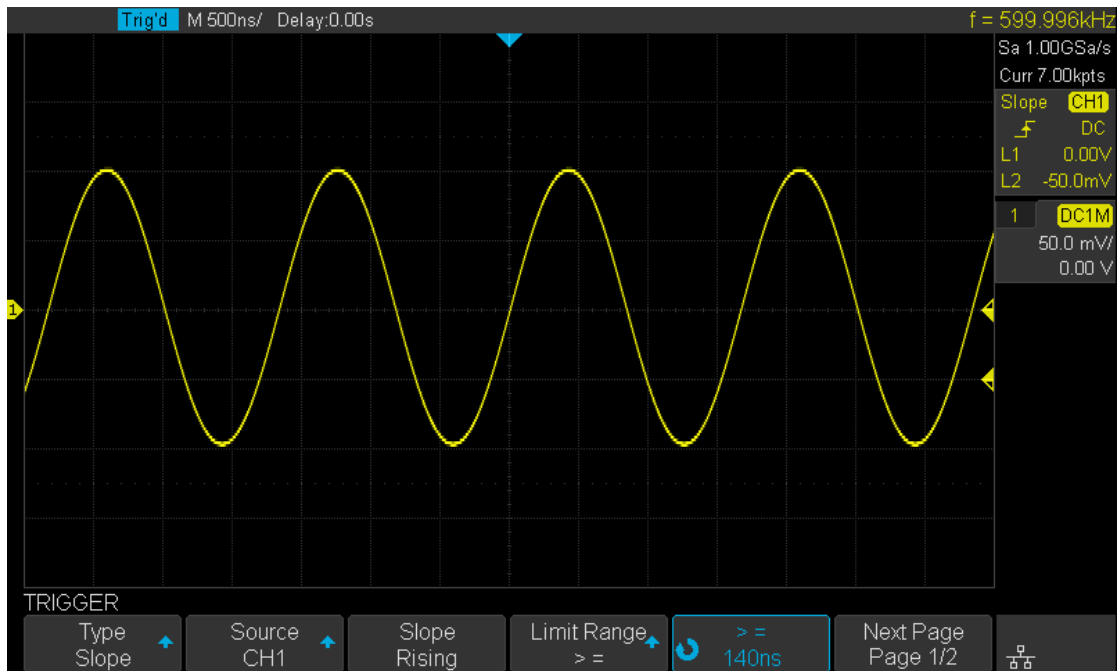
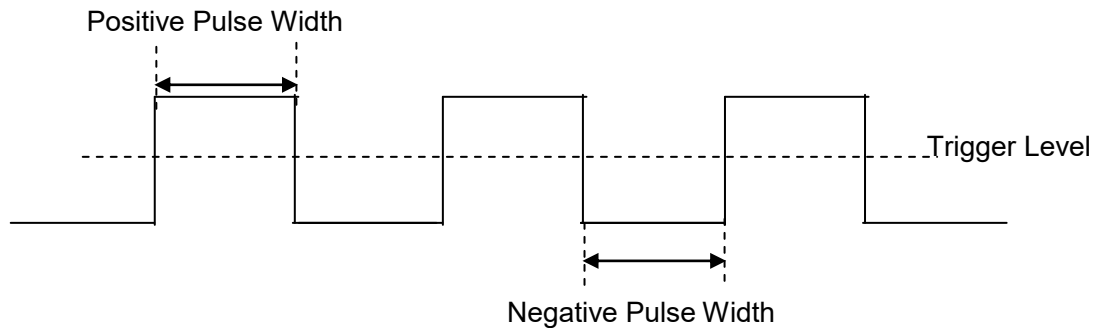

Figure 28 Slope Trigger

6. Press the **Limit Range** softkey; then turn the **Universal Knob** to select the desired slope condition, and push down the knob to confirm.
 - **<=** (less than a time value): trigger when the positive or negative slope time of the input signal is lower than the specified time value.
 - **>=** (greater than a time value): trigger when the positive or negative slope time of the input signal is greater than the specified time value.
 - **[--,--]** (within a range of time value): trigger when the positive or negative slope time of the input signal is greater than the specified lower limit of time and lower than the specified upper limit of time.
 - **--][--** (outside a range of time value): trigger when the positive or negative slope time of the input signal is greater than the specified upper limit of time or lower than the specified lower limit of time.

Pulse Trigger

Trigger on the positive or negative pulse with a specified width.



1. Press the **Setup** button on the front panel to enter the TRIGGER function menu.
2. Press the **Type** softkey; turn the **Universal Knob** to select **Pulse** and then push the knob to confirm.
3. Press the **Source** softkey; turn the **Universal Knob** to select CH1 or CH2 as the trigger source.
4. Turn the **Trigger Level Knob** to adjust the trigger level to the desired place.
5. Press the **Polarity** softkey to select **Positive** or **Negative** pulse to trigger on. The current trigger polarity is displayed at the upper right corner of the screen.
6. Press the **Limit Range** softkey; turn the **Universal Knob** to select the desired condition.
 - **<=** (less than a time value): trigger when the positive or negative pulse time of the input signal is lower than the specified time value.
For example, for a positive pulse, if you set t (pulse real width) $< 100\text{ns}$, the waveform will trigger according to the diagram below.



- **>=** (greater than a time value): trigger when the positive or negative pulse time of the input signal is greater than the specified time value.
For example, for a positive pulse, if you set t (pulse real width) $> 100\text{ns}$, the waveform will trigger according to the diagram below.



- **[--,--]** (within a range of time value): trigger when the positive or negative pulse time of the input signal is greater than the specified lower limit of time and lower than the specified upper limit of time value.
For example, for a positive pulse, if you set t (pulse real width) >100ns and <300ns, the waveform will trigger on the 200ns pulse.

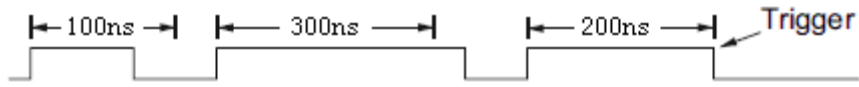

- **--][--** (outside a range of time value): trigger when the positive or negative pulse time of the input signal is greater than the specified upper limit of time and lower than the specified lower limit of time value.

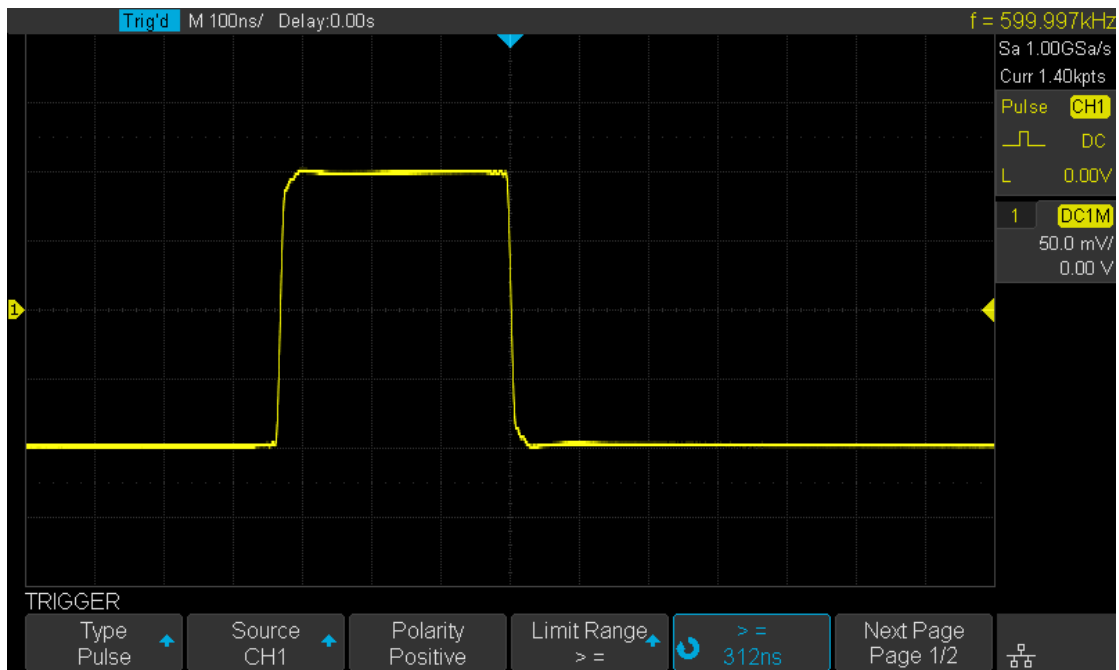

Figure 29 Pulse Trigger

Video Trigger

Video triggering can be used to capture the complex waveforms of most standard analog video signals. The trigger circuitry detects the vertical and horizontal interval of the waveform and produces triggers based on the video trigger settings you have selected. The oscilloscope supports standard video signal field or line of NTSC (National Television Standards Committee), PAL (Phase Alternating Line) HDTV (High Definition Television) and custom video signal trigger.

1. Press the **Setup** button on the front panel to enter the TRIGGER function menu.
2. Press the **Type** softkey; then turn the **Universal Knob** to select **Video** and push down the knob to confirm.
3. Press the **Source** softkey; turn the **Universal Knob** to select CH1 or CH2 as the trigger source. Turning the **Trigger Level Knob** does not change the trigger level because the trigger level is automatically set to the sync pulse.
4. Press the **Standard** softkey to select the desired video standard. The oscilloscope supports the following video standards.

Standard	Type	Sync Pulse
NTSC	Interlaced	BI-level
PAL	Interlaced	BI-level
HDTV 720P/50	Progressive	Tri-level
HDTV 720P/60	Progressive	Tri-level
HDTV 1080P/50	Progressive	Tri-level
HDTV 1080P/60	Progressive	Tri-level
HDTV 1080i/50	Progressive	Tri-level
HDTV 1080i/50	Progressive	Tri-level
Custom		

The table below shows the parameters of the Custom video trigger.

Frame Rate	25Hz, 30Hz, 50Hz, 60Hz	
Of Lines	300 - 2000	
Of Fields	1, 2, 3, 4	
Interlace	1:1, 2:1, 4:1, 8:1	
Trigger Position	Line	Field
	(line value)/1	1
	(line value)/2	2
	(line value)/3	3
	(line value)/4	4
	(line value)/5	5
	(line value)/6	6
	(line value)/7	7
	(line value)/8	8

The table below takes **Of Lines** as 800 as an example to explain the relation between **Of Lines, Of Fields, Interlace, Trigger Line** and **Trigger Field**.

Of Lines	Of Fields	Interlace	Trigger Line	Trigger Field
800	1	1:1	800	1
800	1,2,4 or 8	2:1	400	1, 1-2, 1-4, 1-8
800	1,2,4 or 8	4:1	200	1, 1-2, 1-4, 1-8
800	1,2,4 or 8	8:1	100	1, 1-2, 1-4, 1-8

5. Press the **Sync** softkey to select **Any** or **Select** trigger mode.
 - **Any**: trigger on any of the horizontal sync pulses
 - **Select**: trigger on the appointed line and field you have set. Press the Line or Field softkey; then turn the **Universal Knob** to set the value.

The following table lists the line numbers per field for each video standard.

Standard	Field 1	Field 2
NTSC	1 to 262	1 to 263
PAL	1 to 312	1 to 313
HDTV 720P/50, HDTV 720P/60	1 to 750	
HDTV 1080P/50, HDTV 1080P/60	1 to 1125	
HDTV 1080iP/50, HDTV 1080i/60	1 to 562	1 to 563

The following are exercises to familiarize you with video triggering.

- To trigger on a specific line of video
- To use Custom video trigger

To Trigger on a Specific Line of Video

Video triggering requires greater than 1/2 division of sync amplitude with any analog channel as the trigger source.

The example below set to trigger on field 2, line 124 using the NTSC video standard.

1. Press the **Setup** button on the front panel to enter the TRIGGER system function menu.
2. Press the **Type** softkey; then use the **Universal Knob** to select Video and push down the knob to confirm.
3. Press the **Source** softkey; turn the Universal Knob to select CH1 as the trigger source, and press the knob to confirm.
4. Press the **Standard** softkey; turn the Universal Knob to select NTSC, and press the knob to confirm.
5. Press the **Sync** softkey and set the option to **Select**; press the **Line** softkey and then turn the universal to select **022** and push the knob to confirm; press the **Field** softkey and then turn the **Universal Knob** to select **1** and push the knob to confirm.

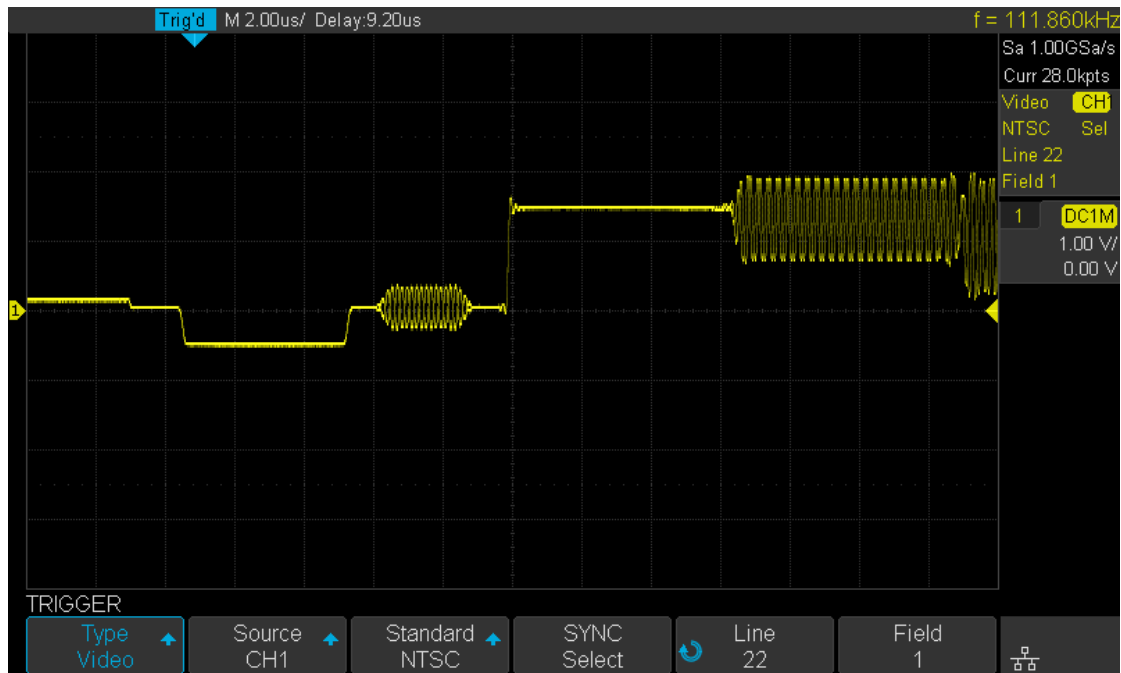

Figure 30 Video Trigger

To Use Custom Video Trigger

Custom video trigger supports frame rate of 25Hz, 30Hz, 50Hz and 60Hz, and the line range is available from 300 to 2000. The steps below show how to set custom trigger.

1. Press the **Setup** button on the front panel to enter the TRIGGER function menu.
2. Press the **Type** softkey; then use the **Universal Knob** to select **Video** and push down the knob to confirm.
3. Press the **Source** softkey; turn the **Universal Knob** to select **CH1** as the trigger source, and push down the knob to confirm.
4. Press the **Standard** softkey; turn the **Universal Knob** to select **Custom**, and push down the knob to confirm.
5. Press the **Setting** softkey to enter the custom setting function menu. Press the **Interlace** softkey; turn the **Universal Knob** to select the desired value.
6. Press the **Of Field** softkey; turn the **Universal Knob** to select the desired value.
7. Press the **Sync** softkey to enter the TRIG ON menu to set the line and field.
 - Press the **Type** softkey to select **Select** or **Any**.
 - If the **Type** option set to **Select**, press the **Line** softkey; turn the **Universal Knob** to select the desired value. Press the **Field** softkey; turn the **Universal Knob** to select the desired value.

Window Trigger

Window trigger provides a high trigger level and a low trigger level. The instrument triggers when the input signal passes through the high trigger level or the low trigger level.

There are two kinds of window types: Absolute and Relative. They have different trigger level adjustment methods. Under Absolute window type, the lower and the upper trigger levels can be adjusted respectively via the Level knob; under Relative window type, adjust the Center value to set the window center; adjust the Delta value to set the window range, the lower and the upper trigger levels always move together.

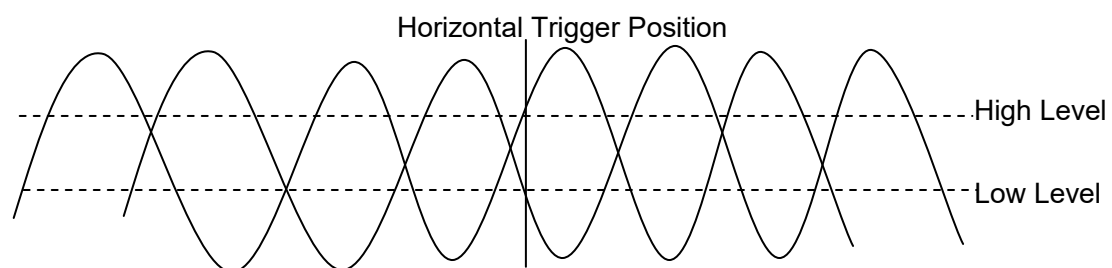

- If the lower and the upper trigger levels are both within the waveform amplitude range, the oscilloscope will trigger on both rising and falling edge.
- If the upper trigger level is within the waveform amplitude range while the lower trigger level is out of the waveform amplitude range, the oscilloscope will trigger on rising edge only.
- If the lower trigger level is within the waveform amplitude range while the upper trigger level is out of the waveform amplitude range, the oscilloscope will trigger on falling edge only.

To set window trigger via Absolute window type:

1. Press the **Setup** button on the front panel to enter the TRIGGER function menu.
2. Press the **Type** softkey; then use the **Universal Knob** to select **Window** and push down the knob to confirm.
3. Press the **Source** softkey; turn the **Universal Knob** to select CH1 or CH2 as the trigger source.
4. Press the Window **Type** softkey to select Absolute.
5. Press the **Lower Upper** softkey to select **Lower** or **Upper** trigger level; then turn the **Trigger Level Knob** to adjust the position. The trigger level values are displayed at the upper right corner of the screen.

The Lower trigger level cannot be higher than the upper trigger level. In the trigger state message box, **L1** means the upper trigger level while **L2** means the lower trigger level.

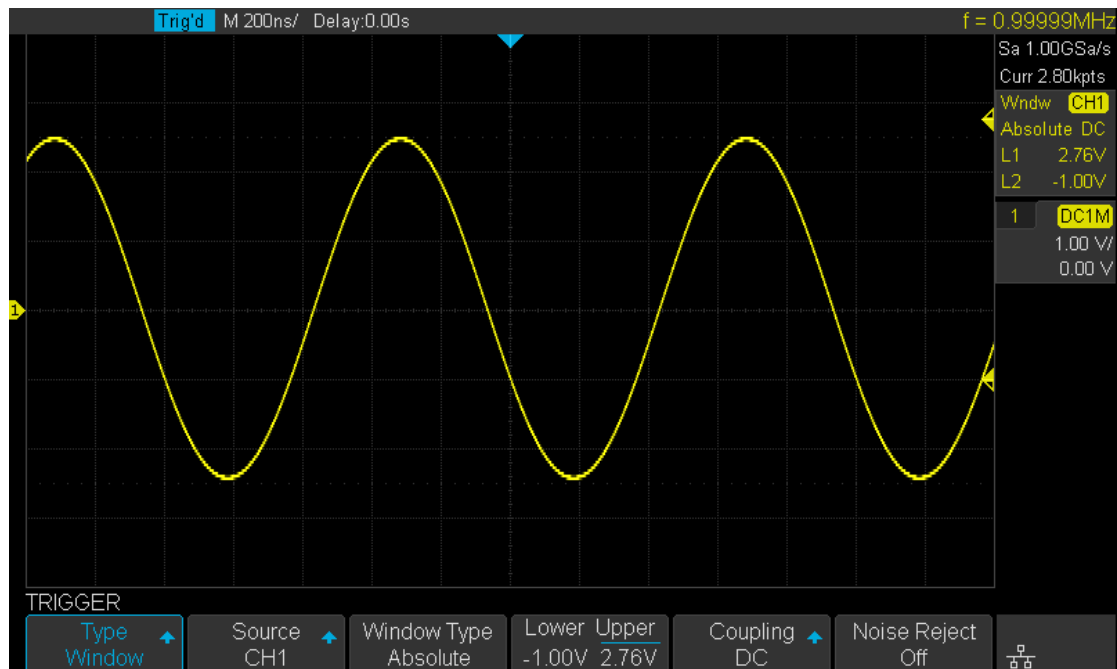

Figure 31 Absolute Window Trigger

To set window trigger via Relative window type:

1. Press the **Setup** button on the front panel to enter the TRIGGER system function menu.
2. Press the **Type** softkey; then use the **Universal Knob** to select **Window** and push down the knob to confirm.
3. Press the **Source** softkey; turn the **Universal Knob** to select CH1 or CH2 as the trigger source.
4. Press the **Window Type** softkey to select **Relative**.
5. Press the **Center Delta** softkey to select **Center** or **Delta** trigger level mode; then turn the **Trigger Level Knob** to adjust the position. The **Center** and **Delta** values are displayed at the upper right corner of the screen.

In the trigger state message box, **C** means **Center**, the center value of the lower and upper trigger levels; **D** means **Delta**, the difference between the lower (or upper) trigger level and the trigger level center.

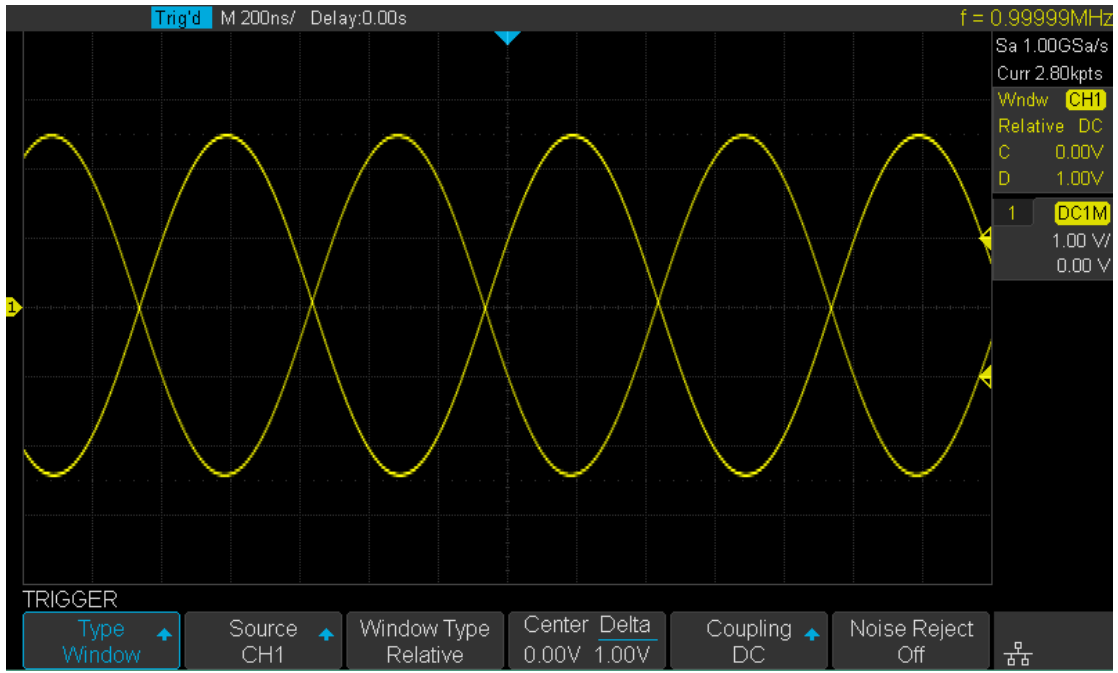
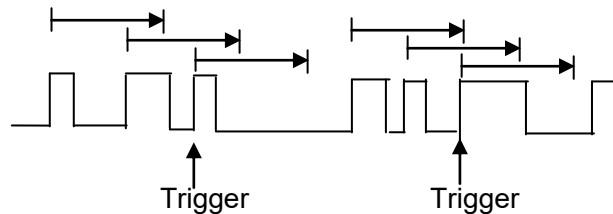

Figure 32 Relative Window Trigger

Interval Trigger

Trigger when the times difference between adjacent rising or falling edges meets the time limit (\leq , \geq , [--,--], --][--).



To set interval trigger:

1. Press the **Setup** button on the front panel to enter the TRIGGER system function menu.
2. Press the **Type** softkey; then use the **Universal Knob** to select **Interval** and push down the knob to confirm.
3. Press the **Source** softkey; turn the **Universal Knob** to select CH1 or CH2 as the trigger source.
4. Press the **Slope** softkey to select rising or falling edge.
5. Press the **Limit Range** softkey; turn the **Universal Knob** to select desired condition.
 - \leq (less than a time value): trigger when the positive or negative pulse time of the input signal is lower than the specified time value.
 - \geq (greater than a time value): trigger when the positive or negative pulse time of the input signal is greater than the specified time value.
 - [--,--] (within a range of time value): trigger when the positive or negative pulse time of the input signal is greater than the specified lower limit of time and lower than the specified upper limit of time.
 - --][-- (outside a range of time value): trigger when the positive or negative pulse time of the input signal is greater than the specified upper limit of time or lower than the specified lower limit of time value.
6. Press the **Time Setting** softkey (\leq , \geq , [--,--],--][--), turn the **Universal Knob** to select the desired value.

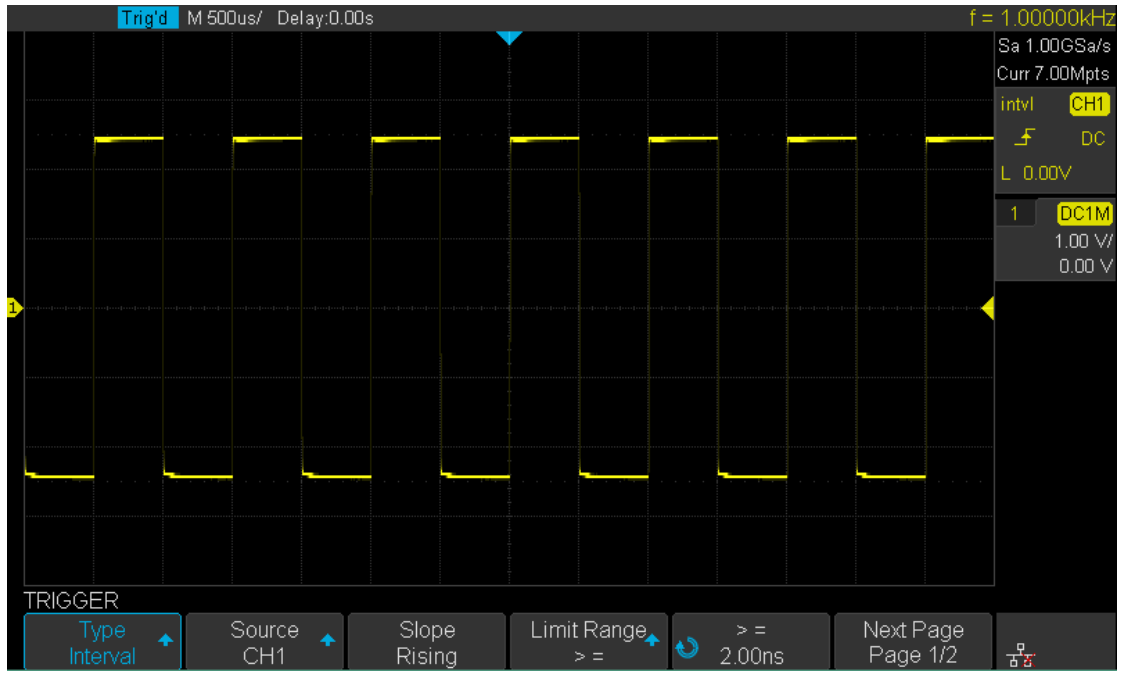

Figure 33 Interval Trigger

DropOut Trigger

DropOut trigger includes two types: edge and state.

Edge

Trigger when the time interval (ΔT) from when the rising edge (or falling edge) of the input signal passes through the trigger level to when the adjacent rising edge (or falling edge) passes through the trigger level is greater than the timeout time set, as shown in the figure below.

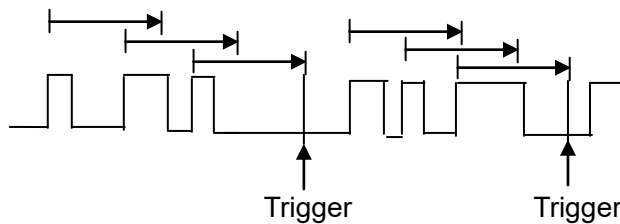

State

Trigger when the time interval (ΔT) from when the rising edge (or falling edge) of the input signal passes through the trigger level to when the adjacent falling edge (or rising edge) passes through the trigger level is greater than the timeout time set, as shown in the figure below.

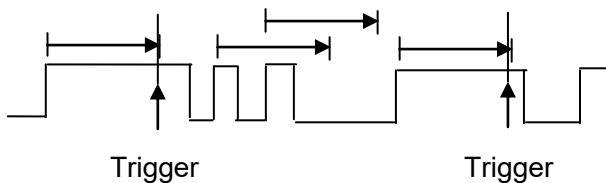

To set edge DropOut trigger:

1. Press the **Setup** button on the front panel to enter the TRIGGER system function menu.
2. Press the **Type** softkey; then use the **Universal Knob** to select **DropOut** and push down the knob to confirm.
3. Press the **Source** softkey; turn the **Universal Knob** to select CH1 or CH2 as the trigger source. The current trigger source is displayed at the upper right corner of the screen. Select channel with signal input as trigger source to obtain stable trigger.
4. Press the **Slope** softkey to select rising or falling edge.
5. Press the **OverTime Type** softkey to select **Edge**.
6. Press the **Time** softkey; turn the universal to select the desired value.

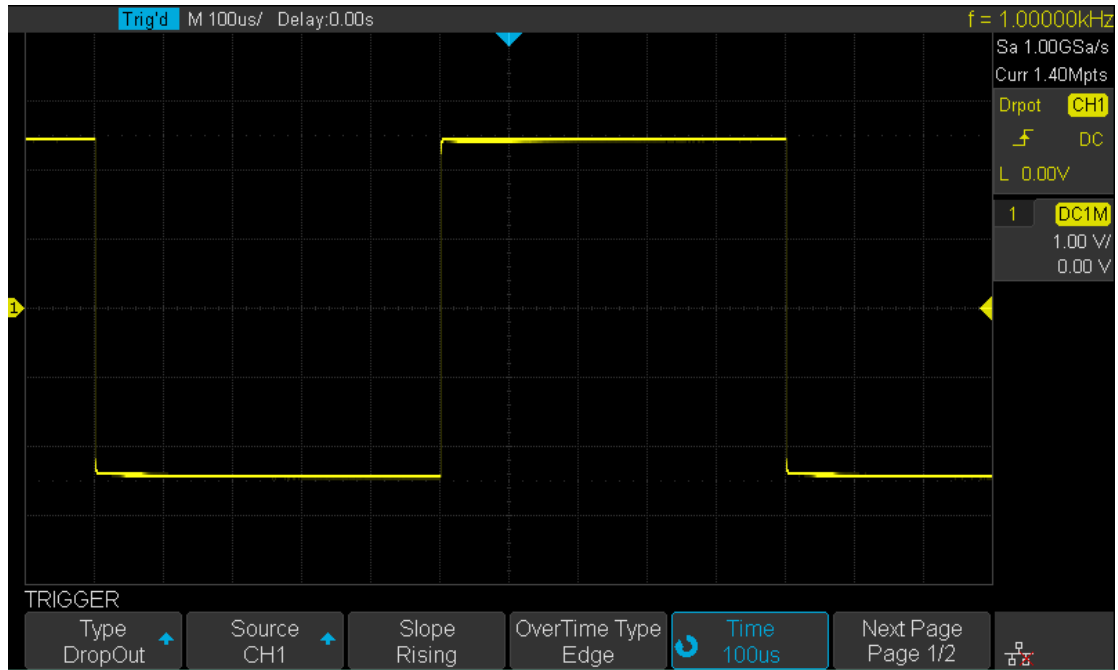

Figure 34 Edge DropOut Trigger

To set state DropOut trigger:

1. Press the **Setup** button to enter the TRIGGER system function menu.
2. Press the **Type** softkey; then turn the **Universal Knob** to select **DropOut** and push down the knob to confirm.
3. Press the **Source** softkey; turn the **Universal Knob** to select CH1 or CH2 as the trigger source.
4. Press the **Slope** softkey to select rising or falling edge.
5. Press the **OverTime** Type softkey to select State.
6. Press the **Time** softkey; turn the **Universal Knob** to select the desired value.

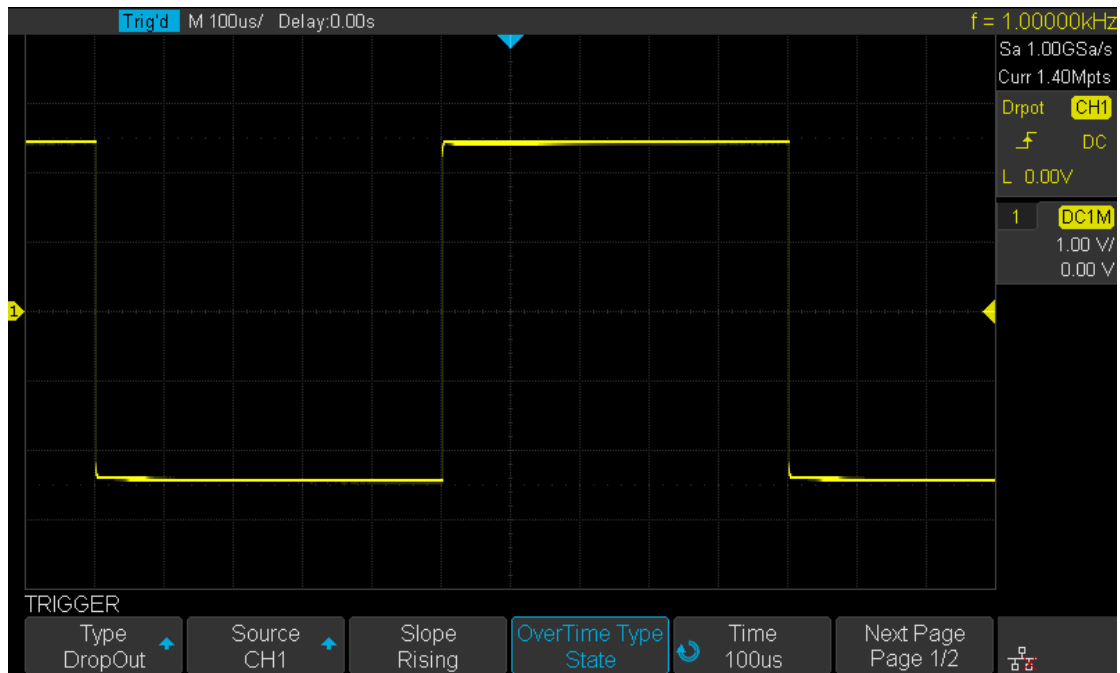
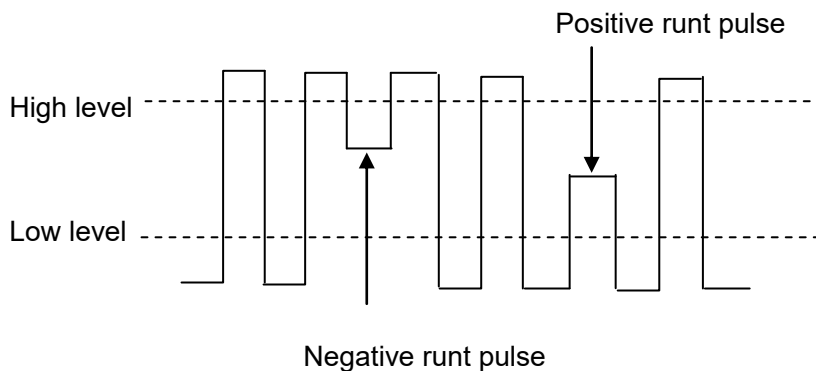

Figure 35 State DropOut Trigger

Runt Trigger

The Runt trigger looks for pulses that cross one threshold but not another as shown in the picture below.



- A positive runt pulse crosses through a lower threshold but not an upper threshold.
- A negative runt pulse crosses through an upper threshold but not a lower threshold.

To trigger on runt pulse:

1. Press the **Setup** button on the front panel to enter the **TRIGGER** system function menu.
2. Press the **Type** softkey; then turn the **Universal Knob** to select **DropOut** and push down the knob to confirm.
3. Press the **Source** softkey; turn the **Universal Knob** to select CH1 or CH2 as the trigger source.
4. Press the **Polarity** softkey to select **Positive** or **Negative** pulse to trigger.

5. Press the **Limit Range** softkey; turn the **Universal Knob** to select the desired condition (\leq , \geq , $[-, -]$ or $-][-]$).
6. Press the **Time Setting** softkey, and then turn the **Universal Knob** to select the desired value.
7. Press the **Next Page** softkey to enter the second page of the TRIGGER system function menu. Press the **Lower Upper** softkey to select **Lower** or **Upper** trigger level, and then turn the **Universal Knob** to set the position.

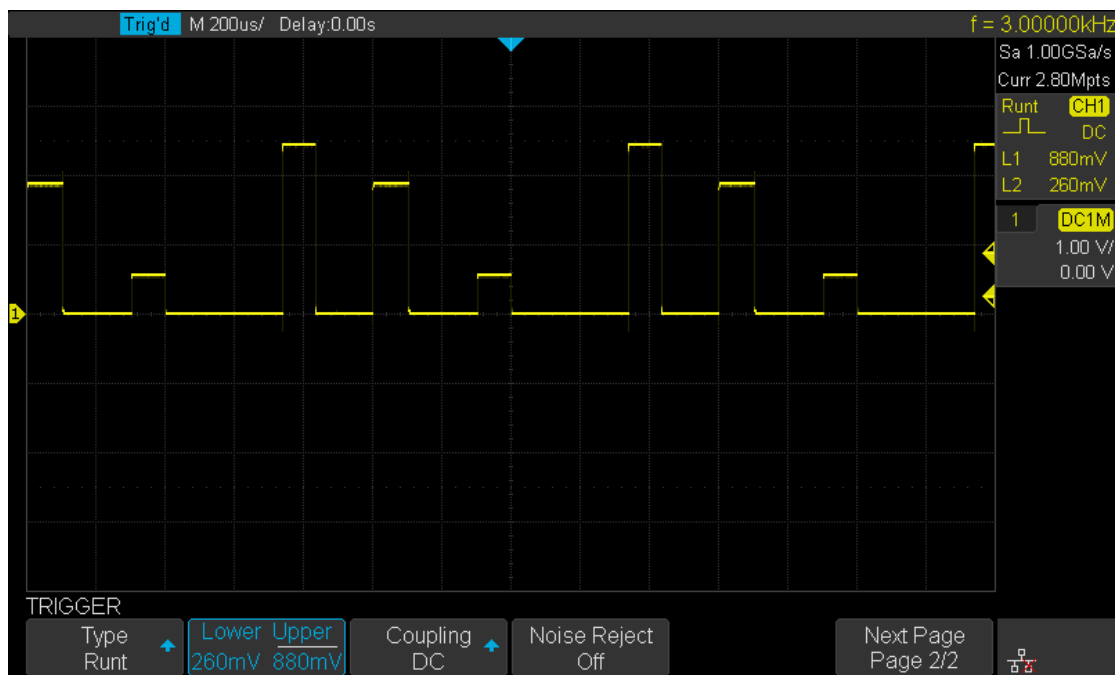
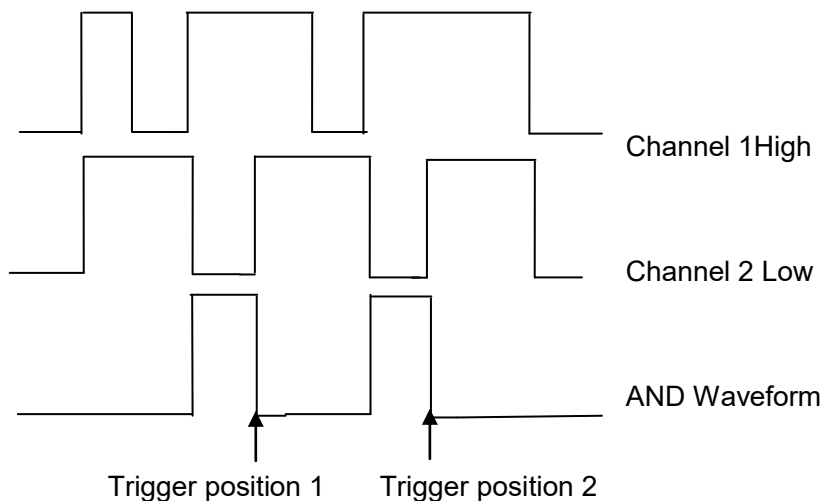

Figure 36 Runt Trigger

Pattern Trigger

The Pattern trigger identifies a trigger condition by looking for a specified pattern. The pattern trigger can be expanded to incorporate delays similar to other triggers. Pattern durations are evaluated using a timer. The timer starts on the last edge that makes the pattern “true”. Potential triggers occur on the first edge that makes the pattern false, provided that the time qualifier criterion has been met. The oscilloscope provides 4 patterns: logical AND, OR, NAND and NOR combination of the channels. Each channel can be set to low, high or invalid.



Do the following steps to set pattern trigger:

1. Press the **Setup** button on the front panel to enter the TRIGGER function menu.
2. Press the **Type** softkey; turn the **Universal Knob** to select Pattern, and then push down the knob to confirm.
3. Press each channel softkey to select **Invalid**, **High** or **Low**.
 - **Low** sets the pattern to low on the selected channel. A low is a voltage level that is less than the channel's trigger level or threshold level.
 - **High** sets the pattern to high on the selected channel. A high is a voltage level that is greater than the channel's trigger level or threshold level.
 - **Invalid** sets the pattern to invalid on the selected channel. Any channel set to invalid is ignored and is not used as part of the pattern.
However, if all channels in the pattern are set to **Invalid**, the oscilloscope will not trigger.
Adjust the trigger level for the selected analog channel by turning the Trigger Level knob. **Invalid** doesn't need to set a trigger level.
4. Press the **Next Page** softkey to enter the second page of the pattern trigger menu.
5. Press the **Logic** softkey and then turn the **Universal Knob** to select the desired logic combination **AND**, **OR**, **NAND** or **NOR**.
6. Press the **Time** softkey; then turn the **Universal Knob** to select the desired time value.
7. Press the **Holdoff Close** softkey to turn on the Holdoff function; then turn the

Universal Knob to select the desired value.

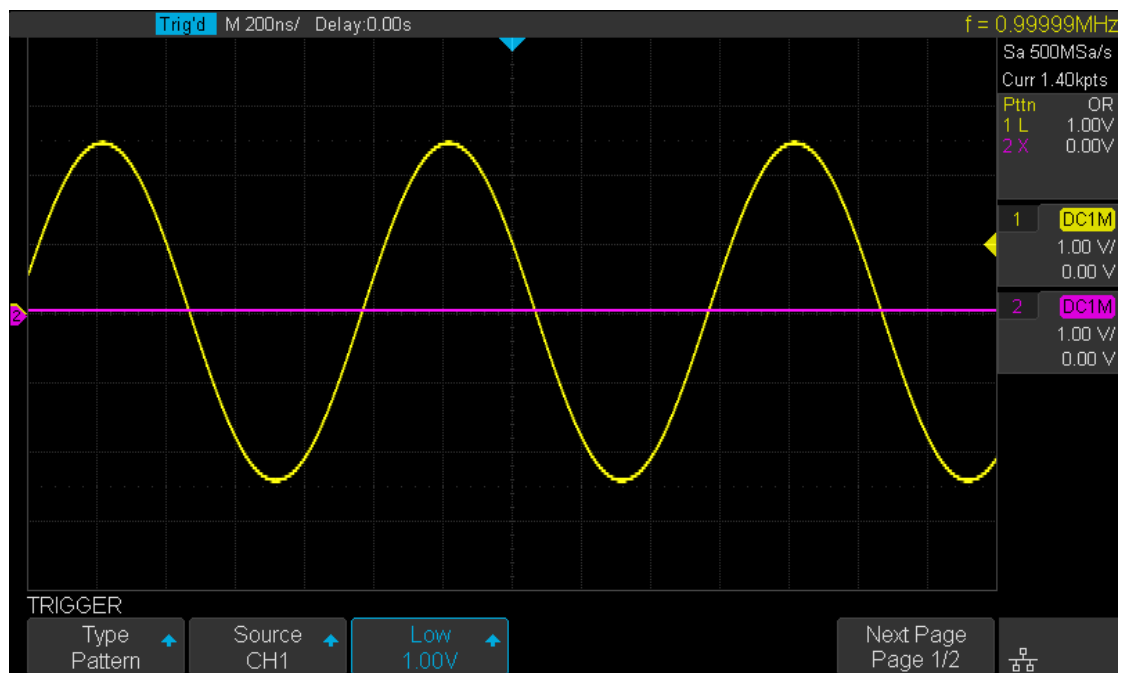

Figure 37 Pattern Trigger

Serial trigger and decode

The oscilloscope provides I2C, SPI, UART/RS232, CAN and LIN serial trigger and decode. This chapter introduces the method of triggering and decoding these serial signals in detail.

The contents of this chapter:

- ◆ I2C Trigger and Decoder
- ◆ SPI Trigger and Decoder
- ◆ UART/RS232 Trigger and Decoder
- ◆ CAN Trigger and Decoder
- ◆ LIN Trigger and Decoder

I2C Trigger and Serial Decode

Three simple steps are necessary to trigger and decode the signals: “**Setup for I2C Signals**”, “**I2C Triggering**” and “**I2C Decode**”.

Setup for I2C Signals

Setting the I2C (Inter-IC bus) signal includes two steps: connecting the serial data signal (SDA) and serial clock signal (SCK) to the oscilloscope, specifying the threshold voltage of each input signal.

1. Press **Decode** key to enter the **DECODE** function menu as Figure 38 shows.



Figure 38 I2C DECODE Menu

2. Press the **Decode** softkey and select the desired decoder (Decode1 or Decode2).
3. Press **Protocol** softkey and then select **I2C** by turning Universal Knob.
4. Press **Signal** softkey to enter the **SIGNAL** menu as Figure 39 shows.



Figure 39 I2C SIGNAL Menu

5. Set SCL (I2C's clock signal):
 - a. Press **SCL** softkey to select the channel that is connected to the I2C clock signal.
 - b. Press **Threshold** softkey to set the I2C clock signal's threshold voltage level Using the Universal Knob. The threshold voltage level is required for decoding, and it will be used as the trigger voltage level when setting the trigger type to serial.
6. Set SDA (I2C's data signal):
 - a. Press **SDA** to select the channel that is connected to the I2C data signal.
 - b. Press second **Threshold** softkey to set the I2C data signal's threshold voltage level using the Universal Knob. The threshold voltage level is for decoding,

and it will be used as the trigger voltage level when setting the trigger type to serial.
(Tips: SDA should be stable during the whole high clock cycle, otherwise it will be interpreted as a start or stop condition (data transitioning while the clock is high).)

7. Press  softkey to return to the previous menu.

I2C Triggering

This part introduces the nine trigger conditions (Start, Stop, Restart, No Ack, EEPROM, 7 Bit Addr & Data, 10 Bit Addr & Data and Data Length) and the methods of setting them.

Introduction to the trigger conditions

- **Start Condition**— the oscilloscope will be triggered when the SDA signal transitions from a high to a low while the SCL clock is high. If it is the trigger condition (including frame triggers), a restart will be treated as a “Start condition”.
- **Stop Condition**— the oscilloscope will be triggered when SDA transitions from low to high while the SCL is high.

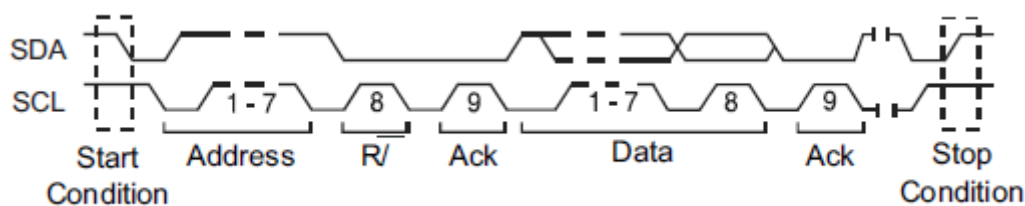

- **Restart**— the oscilloscope will be triggered when another “Start condition” occurs before a “Stop condition”.
- **No Ack**— the oscilloscope will be triggered when SDA data is high during any SCL’s ACK bit.
- **EEPROM** — the trigger searches for EEPROM control byte (the value is 1010xxx) on the SDA bus. And there is a Read bit and a ACK bit following EEPROM. Using **Limit Range** softkey to set the qualifier and **Data1** softkey to set the data’s value. If EEPROM’s data is greater (less, equal) than Data1, the oscilloscope will be triggered at the edge of ACK bit behind Data byte. It’s unnecessary that the Data byte must follow the EEPROM.

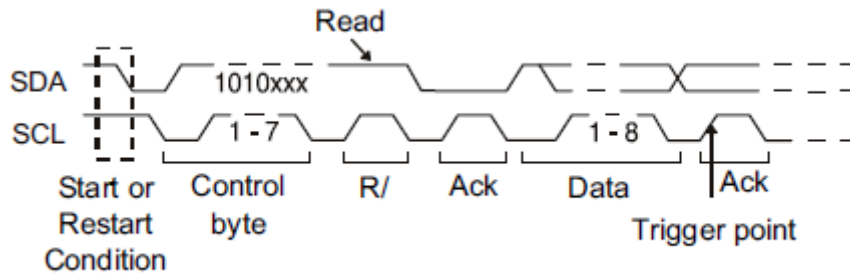

Read

- **7 Bit Address & Data** — the oscilloscope will be triggered when the following conditions are satisfied.
 - The address's length must be 7 bits and the address's value is the same as the address trigger value.
 - If you have set either Data1's or Data2's value, and the signal has data that is the same as that value. If you have set both Data1's and Data2's value, the signal should have two consecutive data values, the first data value is Data1, second data value is Data2.

(**Note:** If the data value is 0xXX, any data value will be matched)

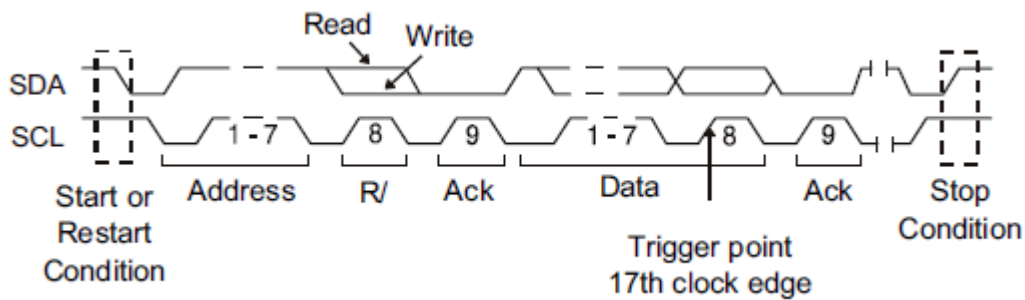

On the 17th Clock Edge

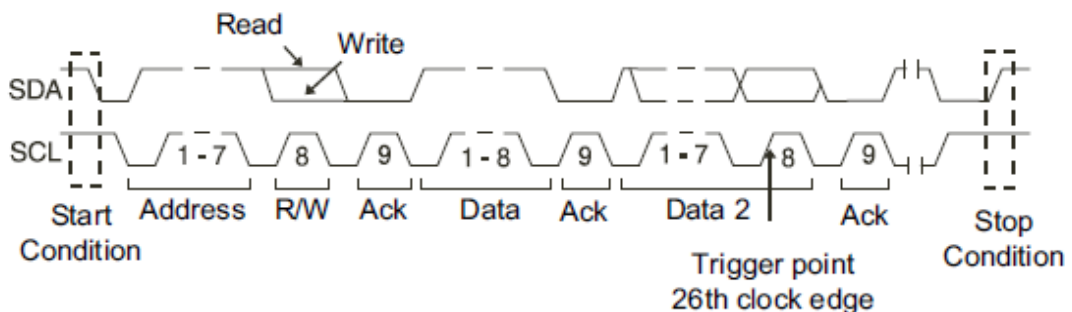

On the 26th Clock Edge

- **10 Bit Address & Data** — the oscilloscope will be triggered when the following conditions are satisfied.
 - The address's length must be 10 bits and the address's value is the same as the address set value.
 - If you have set either Data1's or Data2's value, and the signal has data that is the same as those values in that order.

(**Note:** If the set value is 0xXX, any data value will be matched)

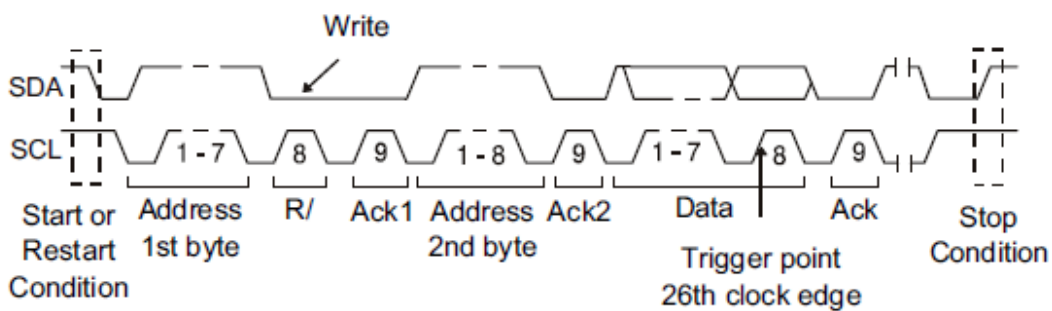

Write

- **Data Length** — When SDA data's length is equal to the value of Byte Length and address's length is the same as the set value, the oscilloscope will be triggered. Byte length is in the range of 1 to 12 bits.

Operation steps:

1. Press **Setup** to enter the **TRIGGER** function menu.
2. Press **Type** and select **Serial**.
3. Press **Protocol** and select **I2C**.
4. Press **Trigger Setting** softkey.

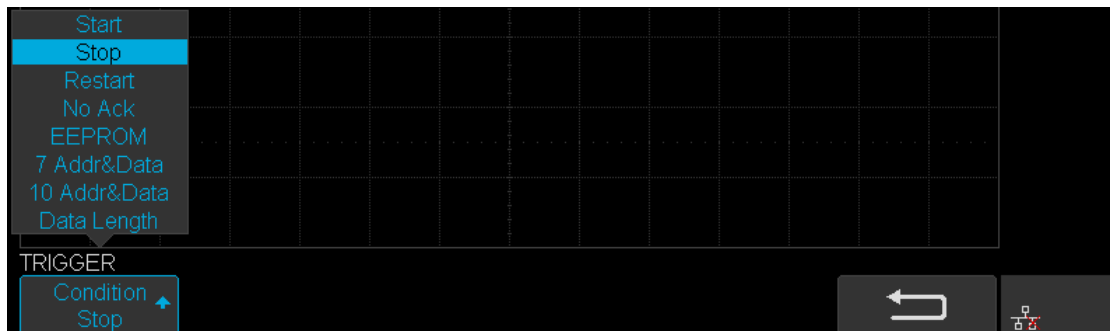

Figure 40 I2C TRIGGER Menu

5. Press the **Condition** softkey and turn the Universal Knob to select the trigger condition:

- If you select the **EEPROM** condition:
 - a. Press the **Limit Range** softkey to set the qualifier (= , < or >).
 - b. Press **Data1** softkey and set its value by turning the Universal Knob.
- If you select **7 Addr & Data** or **10 Addr & Data** condition:
 - a. Press the **Addr** softkey and turn the Universal Knob to select the 7- bit or 10-bit device address.
 - b. Press the **Data1** or **Data2** softkey and set the value of them.
 - c. Press The **R/W bit** softkey and select write-frame or read-frame to trigger the oscilloscope.

(**Tips:** If device address is 7-bit, the value of the address is in the range of 0x00 to 0x7F. If the device address is 10-bit, the value of the address is in the range of 0x00 to 0x3FF.)

- To select the **Data Length** condition:
 - a. Press **Address** to set the SDA address length to 7 bit or 10 bit.
 - b. Press **Byte Length** softkey and set the byte length using the Universal Knob. The range of the Byte Length is 1 to 12.

I2C Serial Decode

After completing the setup of I2C signal and trigger, we will decode I2C signals.

Steps are as follows.

1. Press **Decode** → **Decode**. Select one of the options from the **Decode1** and **Decode2**.



Figure 41 I2C Decode Menu

2. Press **Display** and select **On** to display the result of decoding.
3. Press **List** to enter the **LIST** function menu.
4. Press **Display** and choose the same options as the first step.
5. Press **Lines** and set the number of lines using the Universal Knob. The range of the lines is 1 to 7.
6. Press **Format** to change the character encoding format of the decoding's result.
7. Press **Scroll** and turn the Universal Knob to view all frames.

Interpreting I2C Decode

The frames of decoding result:

- The address of write frame is a dark-green string that contains “W”.
- The address of read frame is a yellow string that contains “R”.
- The data of data frames are white strings.

The lists of decoding results:

- NO — the number of frames in the screen.
- TIME (timestamp) — the horizontal displacement between the current frame and the trigger position.
- ADDRESS — the address of a frame.
- RW — the type of a frame (write or read).
- DATA — the value of data.

SPI Triggering and Serial Decode

Three simple steps are necessary to trigger and decode the signals: “**Setup for SPI Signals**”, “**SPI Triggering**” and “**SPI Decode**” to trigger and decode the signals.

Setup for SPI Signals

Setting the SPI (Serial Peripheral Interface) signal includes two steps: connecting the CLK, MISO, MOSI and CS signals to oscilloscope; specifying the parameters of each input signal.

1. Press the **Decode** key to enter the **DECODE** function menu.
2. Press the **Decode** softkey and select the desired decoder (Decode1 or Decode2).
3. Press **Protocol** softkey and then select **SPI** by turning the Universal Knob.
4. Press **Signal** softkey to enter the **SIGNAL** menu as Figure 42 shows.



Figure 42 SIGNAL Menu

5. Set CLK (clock signal):
 - a. Press the **CLK** softkey to enter **CLK** menu.
 - b. Press the **CLK** softkey to select the channel that is connected to the SPI clock signal.
 - c. Press the **Threshold** softkey to set the SPI clock signal's threshold voltage level using the Universal Knob. The threshold voltage level is for decoding, and it will be used as the trigger voltage level when setting the trigger type to serial.
 - d. Press the **Edge Select** softkey to set the oscilloscope to sample at the clock signal's rising edge or falling edge.
 - e. Press  softkey to return to the previous menu.

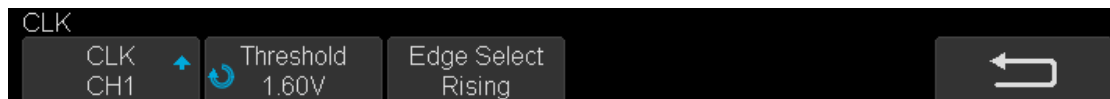

Figure 43 CLK Menu

6. Set MISO:
 - a. Press the **MISO** softkey to enter the MISO menu.
 - b. Press the **MISO** softkey to select the channel that is connected to the SPI MISO signal.
 - c. Press the **Threshold** softkey to set the SPI MISO signal's threshold voltage level using the Universal Knob. The threshold voltage level is for decoding, and it will be used as the trigger voltage level when setting the trigger type to serial.
 - d. Press  softkey to return previous menu.



Figure 44 MISO Menu

7. Set MOSI:
 - a. Press the **MOSI** softkey to enter the MOSI menu.
 - b. Press the **MOSI** softkey to select the channel that is connected to the SPI MOSI signal.
 - c. Press the **Threshold** softkey to set the SPI MOSI signal's threshold voltage level using the Universal Knob. The threshold voltage level is for decoding, and it will be used as the trigger voltage level when setting the trigger type to serial.
 - d. Press  softkey to return previous menu.



Figure 45 MOSI Menu

8. Set CS:
 - a. Press the **CS** softkey to enter the MOSI menu.
 - b. Press the **CS Type** softkey to select the chip select type.
 - c. Modify the CS type's value.
 - d. Press  softkey to return previous menu.

Table 1 Menu Explanations of the CS Type Parameters

Function Menu	Settings	Explanation
CS Type	~CS	low voltage level of CS signal is available
	CS	high voltage level of CS signal is available
	CLK Timeout	If the time between two edges of clock signal is less than (or equal to) the value of timeout, the signal between the two edges is treated as a frame. The range of clock timeout is 100ns-5ms.

9. Press the **Bit Order** softkey to select the bit order (**LSB** or **MSB**).

SPI Triggering

This part will provide a brief introduction and description for the operation of the SPI trigger.

1. Press **Setup** key to enter the **TRIGGER** function menu.
2. Press **Type** and select **Serial**.
3. Press **Protocol** and select **SPI**.
4. Press **Trigger Setting** softkey.



Figure 46 SPI TRIG SET Menu

5. Press the **Trigger Type** softkey to select the trigger condition.

Table 2 Menu, the SPI trigger types

Function Menu	Settings	Explanation
Trigger Type	MISO	Master-In, Slave-Out
	MOSI	Master-Out, Slave-In

6. Press the **Data Length** softkey, and turn the Universal Knob to set the length of a data.
The range of data length is 4 to 96 bits.
7. Set the value of the trigger data.
 - Set the value of a bit:
 - a. Press the **Bit Roll** softkey to select a bit in the data.
 - b. Press the **Bit Value** softkey to set the value of the selected bit.
 - Set the value of all bits:
 - a. Press the **All Same** softkey to set the value of all bits.

Table 3 Menu Explanation of the SPI Bit value

Function Menu	Settings	Explanation
Bit Value	0	High voltage level
	1	Low voltage level
	X	Invalid voltage level

8. Press the **Next Page** softkey.
9. Press the **Bit Order** softkey to set the bit order (MSB or LSB).

SPI Serial Decode

After completing the setup of SPI signal and trigger, we will decode SPI signals.

Operation steps as follows.

1. Press **Decode** → **Decode**. Select one of the options from the **Decode1** and **Decode2**.
2. Press **Display** and select **On** to display the result of decoding.
3. Press **List** to enter the **LIST** function menu.
4. Press **Display** and choose the same options as the first step.
5. Press **Lines** and set the number of lines using the Universal Knob. The range of the lines is 1 to 7.
6. Press **Format** to change the character encoding format of the decoder's result.
7. Press **Scroll** and turn the Universal Knob to view all frames.

Interpreting SPI Decode

The frames of decoding result:

- MISO — the decoding result of “Master-In, Slave-Out” line.
- MOSI —the decoding result of “Master-Out, Slave-In” line.

The lists of decoding result:

- NO — the number of frames in screen.
- TIME (timestamp) — the horizontal displacement between current frame and trigger position.
- MISO — the decoding result of “Master-In, Slave-Out” line.
- MOSI —the decoding result of “Master-Out, Slave-In” line.

UART/RS232 Triggering and Serial Decode

The three steps to set up the UART / RS232: “**Setup for UART/RS232 Signals**”, “**UART/RS232 Triggering**” and “**UART/RS232 Decode**” to trigger and decode the signals.

Setup for UART/RS232 Signals

1. Press the **Decode** key to enter the **DECODE** function menu.
2. Press the **Decode** softkey and select the desired decoder (Decode1 or Decode2).
3. Press **Protocol** softkey and then select **UART** by turning the Universal Knob.
4. Press **Signal** softkey to enter the **SIGNAL** menu as in Figure 47 below.



Figure 47 UART SIGNAL Menu

5. Set RX:
 - 1) Press **RX** to select the channel that is connected to the RX signal.
 - 2) Press the **Threshold** key to set the RX signal's threshold voltage level using the Universal Knob. The threshold voltage level is for decoding, and it will be used as the trigger voltage level when setting the trigger type to serial.
6. Set TX:
 - 1) Press **TX** to select the channel that is connected to the TX signal.
 - 2) Press first **Threshold** key to set the TX signal's threshold voltage level by Universal Knob. The threshold voltage level is for decoding, and it will be regarded as the trigger voltage level when set the trigger type to serial.
7. Press **Return** softkey to return previous menu.
8. Press the **Configure** softkey to enter **BUS CONFIG** menu.



Figure 48 BUS CONFIG Menu

9. Press **Baud** softkey to set baud rate.
 - The baud rate can be set as a predefined value.
 - If the desired baud rate is not listed, press **Baud** and select **custom** option, press the **Custom** and turn the Universal Knob to set the desired baud rate.
10. Press **Data Length** softkey and set byte bits (5-8) using the Universal Knob.
11. Press **Parity Check** softkey to set the type of parity check (Even, Odd or None).
12. Press **Stop Bit** softkey to set the length of stop bit (1, 1.5 or 2 bits).
13. Press **Next Page** softkey.
14. Press the **Bit Order** softkey to select the bit order (**LSB** or **MSB**).
15. Press **Idle Level** softkey to set the idle level (LOW or HIGH).

UART/RS232 Triggering

This part shows a brief introduction and description for the operation of the UART trigger.

1. Press **Setup** key to enter the **TRIGGER** function menu.
2. Press **Type** and select **Serial**.
3. Press **Protocol** and select **UART**.
4. Press **Trigger Setting** softkey to enter **UART TRIG SET** menu.



Figure 49 UART TRIG SET Menu

5. Press the **Source Type** softkey to select the source of the trigger (RX or TX).
6. Press the **Condition** softkey and set up the desired trigger condition:
 - **Start** — the oscilloscope will be triggered at the position of the start bit.
 - **Stop** —the oscilloscope will be triggered at the position of stop bits.
 - **Data** — the oscilloscope will be triggered when a byte is found which is equal to (not greater or less than) the specified data.
 - a. Press the **Compare Type** softkey and choose an equality qualifier (>, < or =).
 - b. Press the **Value** softkey to set the data value. Select a Data value is in range of 0x00 to 0xff.
 - **ERROR** — if the parity check has been set, and the checked parity bit shows an error, then the oscilloscope will be triggered.

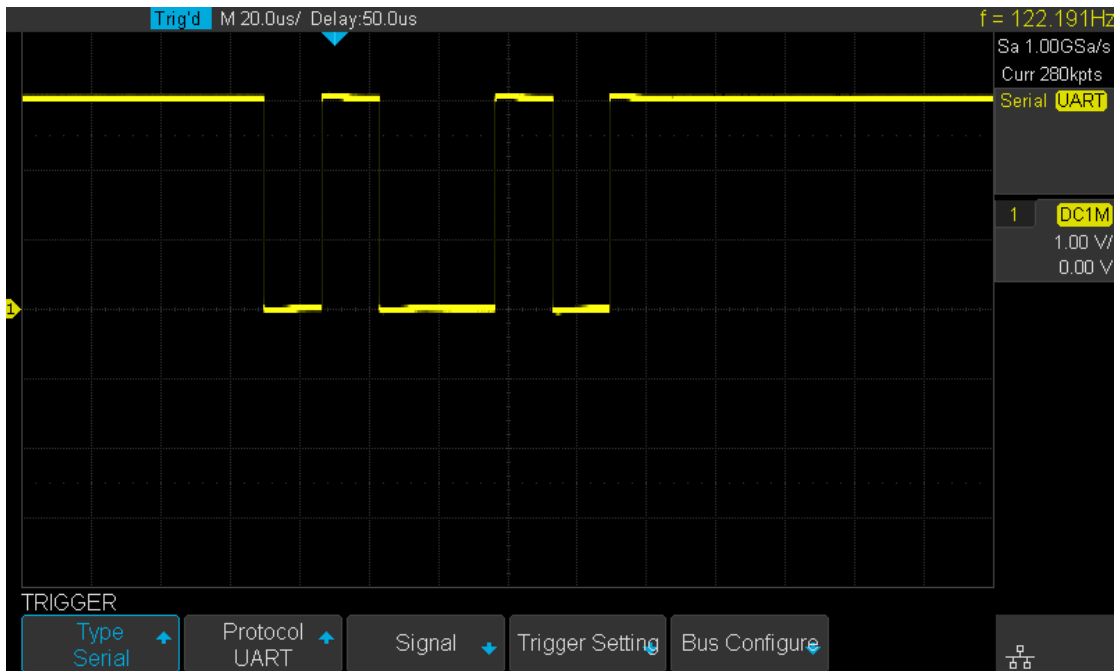

Figure 50 UART Trigger

UART/RS232 Serial Decode

After completing the setup of UART signal and trigger, we will decode UART signals.

Operation steps as follows.

1. Press **Decode** → **Decode**. Select one of the options from the **Decode1** and **Decode2**.
2. Press **Display** and select **On** to display the result of decoding.
3. Press **List** to enter the **LIST** function menu.
4. Press **Display** and choose the same options as the first step.
5. Press **Lines** and set the number of lines using the Universal Knob. The range of the lines is 1 to 7.
6. Press **Format** to change the character encoding format of the decoding's result.
7. Press **Scroll** and turn the Universal Knob to view all frames.

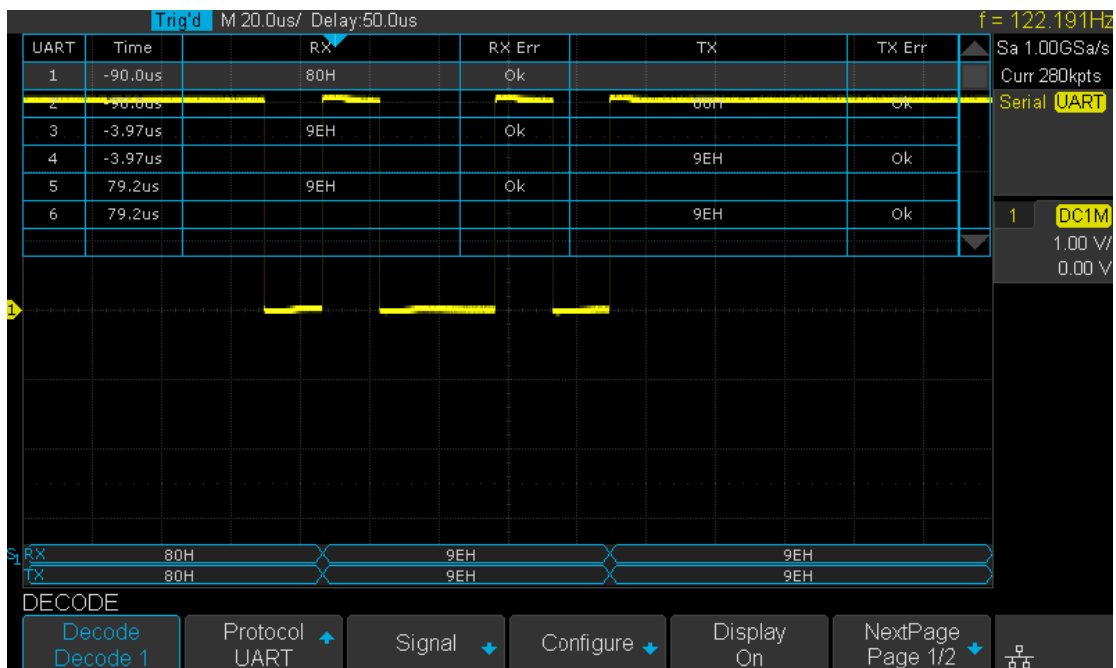

Figure 51 UART/RS232 Decode

Interpreting UART/RS232 Decode

The frames of decoding result:

- RX — the decoding result of the data received.
- TX — the decoding result of the data transmitted.

The lists of decoding result:

- NO — the number of frames on the display.
- TIME (timestamp) — the horizontal displacement between current frame and trigger position.
- RX — the receiving channel.
- TX — the transmitting channel.
- RX ERR— Parity error or unknown error in the data received.
- TX ERR— Parity error or unknown error in the data transmitted.

CAN Trigger and Serial Decode

The steps required for CAN trigger and decode “**Setup for CAN Signals**”, “**CAN Triggering**” and “**CAN Serial Decode**” to trigger and decode the signals.

Setup for CAN Signals

1. Press the **Decode** key to enter the **DECODE** function menu.
2. Press the **Decode** softkey and select the desired decoder (Decode1 or Decode2).
3. Press **Protocol** softkey and then select **CAN** by turning Universal Knob.
4. Press **Signal** softkey to enter the **SIGNAL** menu as Figure 52 shows.



Figure 52 CAN SIGNAL Menu

5. Set CAN-H:
 - a. Press **CAN-H** softkey to select the channel that is connected to the CAN-H signal.
 - b. Press first **Threshold** key to set the CAN-H signal’s threshold voltage level using the **Universal Knob**. The threshold voltage level is for decoding, and it will be used as the trigger voltage level when setting the trigger type to serial.
6. Set CAN-L:
 - a. Press **CAN-L** to select the channel that is connected to the CAN-L signal.
 - b. Press second **Threshold** key to set the CAN-L signal’s threshold voltage level using the **Universal Knob**. The threshold voltage level is for decoding, and it will be used as the trigger voltage level when setting the trigger type to serial.
7. Press the **Configure** softkey to enter the **BUS CONFIG** menu.
8. Press **Baud** to set baud rate using the Universal Knob.
 - The baud rate can be set at predefined values (from 5kb/s to 1Mb/s) or custom values (from 5kb/s to 1Mb/s).
 - If the desired baud rate is not listed, press **Baud** and select **custom** option, press

the **Custom** and turn the Universal Knob to set the desired baud rate.

9. Press **Decode Source** to select the signal to be decoded.

- **CAN_H** — CAN_H signal will be decoded.
- **CAN_L** — CAN_L signal will be decoded.
- **CAN_H-CAN_L** — CAN_H and CAN_L are both used as the source of decoding.

CAN Triggering

This part will provide a brief introduction and description for the operation of the LIN trigger.

To introduce the trigger conditions

- **Start**— the oscilloscope will be triggered at the start bit of a frame.
- **Remote** — the oscilloscope will be triggered by a remote frame with specified ID.
- **ID** — the oscilloscope will be triggered by a remote or data frame that has a specified ID.
- **ID+DATA**— the oscilloscope will be triggered by a data frame that has a specified ID and data.
- **Error** — the oscilloscope will be triggered by an error frame.

Operation steps:

1. Press **Setup** to enter the **TRIGGER** function menu.
2. Press **Type** and select **Serial**.
3. Press **Protocol** and select **CAN**.
4. Press **Trigger Setting** to enter the **CAN TRIG SET** menu.
5. Press **Condition** and select the trigger condition using the Universal Knob:
 - If you select the **REMOTE** and **ID** condition:
 - a. Press **ID Bits** to set the length of the ID (11bits or 29 bits).
 - b. Press **Curr ID Byte** and use Universal Knob to select the byte that you want to set.
 - c. Press the **ID** and set the ID's value using the Universal Knob.

(**Tips:** In order to make it convenient for the operator to set the parameters, ID length is split into several bytes. For example, if the ID's length is 11 bits, it will be split into two bytes, a byte is 8 bits. If "1st byte" is selected, only the 8 least

significant bits can be changed.)

- If you select the **ID+DATA** condition:
 - a. Press **ID bits** softkey to select the ID's length (11 or 29 bits).
 - b. Press **Curr ID Byte** softkey and use Universal Knob to select the byte that you want to modify.
 - c. Press the **ID** softkey and set the ID's value using the Universal Knob.
 - d. Press **Data1** softkey and set the value of the first byte using the Universal Knob.
 - e. Press **Data2** softkey and set the value of the second byte using the Universal Knob.

See figure 56, the trigger condition is ID, ID's value is 0x013, Baud rate is 100kb/s:

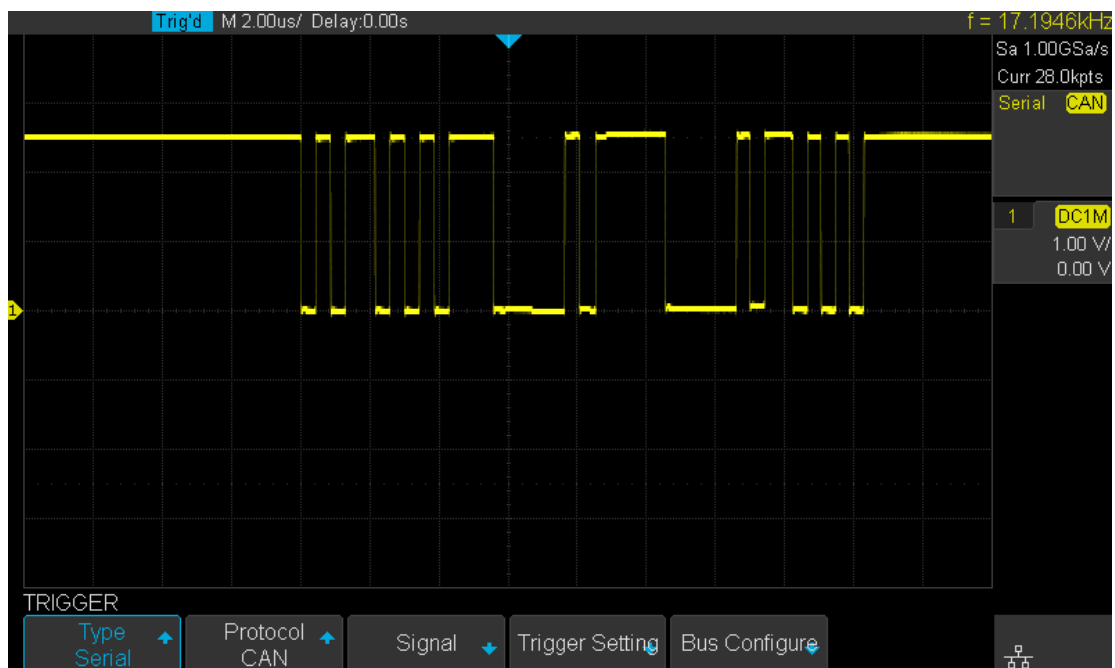

Figure 53 CAN Trigger

CAN Serial Decode

We will decode CAN signals after completing the setup of the CAN signal and trigger.

Operation steps as follows.

1. Press **Decode** → **Decode**. Select one of the options from the **Decode1** and **Decode2**.
2. Press **Display** and select **On** to display the result of decoding.
3. Press **List** to enter the **LIST** function menu.
4. Press **Display** and choose the same options as the first step.
5. Press **Lines** and set the number of lines using the Universal Knob. The range of the lines is 1 to 7.
6. Press **Format** to change the character encoding format of the decoder's result.
7. Press **Scroll** and turn the Universal Knob to view all frames.

Interpreting CAN Decode.

The frame of decoding results:

- Arbitration field is displayed in the frame
- Control field is displayed in the frame
- Data field is displayed in the frame
- CRC field is displayed in the frame

The list of decoding result:

- NO — the number of frames on the screen.
- TIME (timestamp) — the horizontal displacement between current frame and trigger position.
- TYPE — the type of frames, “D” represents data frame, “R” represents remote frame.
- ID — the id of frames, the oscilloscope can automatically detect the length of frame’s id (11 bits or 27 bits).
- LENGTH — the length of data field.
- DATA — the value of data field.
- CRC — the value of CRC (Cyclic Redundancy Check) field.
- ACK — Acknowledgment bit.

LIN Triggering and Serial Decode

LIN Trigger and decode steps: “**Setup for LIN Signals**”, “**LIN Triggering**” and “**LIN Decode**” to trigger and decode the signals.

Setup for LIN Signals

There are two steps for setting the LIN signal, connecting the signal to oscilloscope, specifying the parameters of each input signal.

1. Press the **Decode** key to enter the DECODE function menu.
2. Press the **Decode** softkey and select the desired decoder (Serial 1 or Serial 2).
3. Press **Protocol** softkey and then select **LIN** by turning Universal Knob.
4. Press **Signal** softkey to enter the **SIGNAL** menu as Figure 54 shows.



Figure 54 LIN SIGNAL Menu

5. Press **Source** softkey to select the channel that is connected to the LIN signal.
6. Press the **Threshold** softkey and set the LIN signal's threshold voltage level using the Universal Knob. The threshold voltage level is for decoding, and it will be used as the trigger voltage level when setting the trigger type to serial.
7. Press **Back** softkey to return to the previous menu.
8. Press the **Configure** softkey to enter the **BUS CONFIG** menu.
9. Press **Baud** softkey to set baud rate.
 - The baud rate can be set as a predefined value.
 - If the desired baud rate is not listed, select **custom** option, press the **Custom** and turn the Universal Knob to set the desired baud rate.

LIN Triggering

This part will provide a brief introduction and description for the operation of the LIN trigger.

The possible trigger conditions

- **Break** — The oscilloscope will be triggered at the position of break field's break delimiter.
- **ID (Frame ID)** — the oscilloscope will be triggered at the position of the identifier field's stop bit, if the value of a frame's ID is equal to specified value.
(Note: If the data's value is 0xXX, any data value will be matched)
- **ID + Data (Frame ID and Data)** — the oscilloscope triggers when a frame with an ID and data equal to the selected values is detected. Use the Universal Knob to select the value for the ID, Data1 and Data2.
 - 1) The ID's value is the same as the value currently set.
 - 2) If you have set either Data1's or Data2's value, and the signal has data that matches that value. If you have set both Data1's and Data2's value, the signal should have two consecutive data, the first data's value is Data1, the second data value is Data2.
(**Note:** If the data's value is 0xXX, any data value will be matched)
- **Data Error** —the oscilloscope will be triggered when errors (such as ID check error, checksum error, sync byte field error) are detected.

Operation steps:

1. Press **Setup** to enter the **TRIGGER** function menu.
2. Press **Type** and select **Serial**.
3. Press **Protocol** and select **LIN**.
4. Press **Trigger Setting** softkey to enter **LIN TRIG SET** menu.

5. Press **Condition** and select the trigger condition using the Universal Knob:

- If you **select ID** condition:

- a. Press **ID** softkey and set its value by turning the Universal Knob.

- If you **select ID+DATA** condition:

- a. Press **ID** softkey and set its value by turning the Universal Knob.

- b. Press **DATA1** softkey and set its value by turning the Universal Knob.

- c. Press **DATA2** softkey and set its value by turning the Universal Knob.

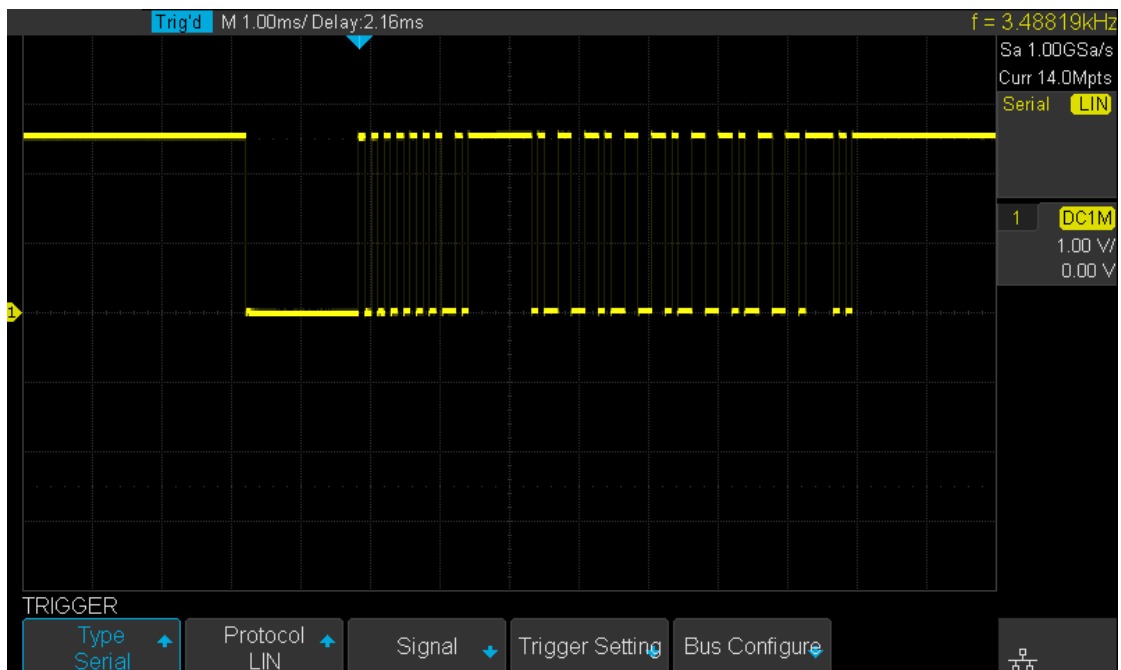

Figure 55 LIN Trigger

LIN Serial Decode

After completing the setup of LIN signal and trigger, we will decode LIN signals.

Operation steps as follows.

1. Press **Decode** → **Decode**. Select one of the options from the **Decode1** and **Decode2**.
2. Press **Display** and select **On** to display the result of decoding.
3. Press **List** to enter the **LIST** function menu.
4. Press **Display** and choose the same options as the first step.
5. Press **Lines** and set the number of lines using the Universal Knob. The range of the lines is 1 to 7.
6. Press **Format** to change the character encoding format of the decoder's result.
7. Press **Scroll** and turn the Universal Knob to view all frames.

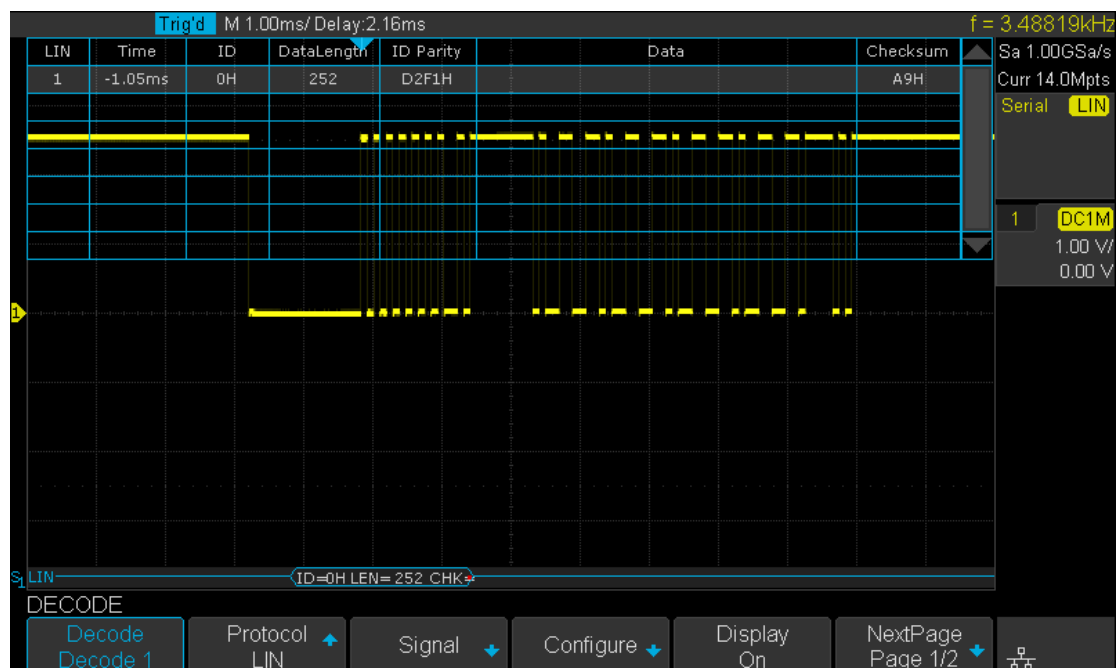

Figure 56 LIN Decode

Interpreting LIN Decode

The frame of decoded results:

- Protected Identifier Field is displayed in frame
- Data Length is displayed in frame
- Data Field is displayed in frame.
- Checksum Field is displayed in frame.

The list of decoding result:

- NO — the number of frames in screen.
- TIME (timestamp) — the horizontal displacement between current frame and trigger position.
- ID — the value of frame's Protected Identifier Field.
- DATA LENGTH — the length of Data Field.
- ID CHECK — the two check bits of Protected Identifier Field.
- DATA — the value of Data Field.
- DATA CHECKSUM — the value of Checksum Field.

To Save A Reference Waveform

The oscilloscope can save analog channels or math waveforms to the reference waveform locations in the oscilloscope. Then, a reference waveform can be displayed and compared against other waveforms. All reference waveforms can be displayed at the same time.

The contents of this chapter:

- How to Save a REF Waveform to Internal Memory
- How to Display a REF Waveform
- How to Adjust a REF Waveform Display
- How to Clear a REF Waveform Display

To Save a REF Waveform to Internal Memory

Do the following steps to save the REF waveform to internal memory:

1. Press the **REF** button on the front to enter the REF WAVE function menu. Note that when the time horizontal format is in X-Y mode, REF function cannot be enabled.
2. Press the **Source** softkey; then, turn the **Universal Knob** to select the source of the reference channel. The source includes analog channels and math waveforms.
3. Press the **Location** softkey; then, turn the **Universal Knob** to select the position to save the REF waveform. The source includes analog channels and math waveforms.
4. Press the **Save** softkey to save the channel or math waveform to the appointed location. The vertical scale information and the vertical offset of the waveform will be saved at the same time. A pop up the message “**Store Data Success**” will appear when the waveform has been saved successfully.

Note: The REF waveforms are non-volatile. The REF waveform can still be viewed after a restart or default operation.

To Display a REF Waveform

Do the following steps to display a REF waveform:

1. Press the **REF** button on the front to enter the REF WAVE function menu.
2. Press the **Location** softkey; then, turn the **Universal Knob** to select the REF waveform that you want to display.
3. Press the **Display** softkey to select **On** to display the REF waveform on the screen.
Only saved locations can be displayed. The oscilloscope can display all four reference waveforms at the same time.

To Adjust the REF Waveform Display

1. Please refer to the “**To Display a REF Waveform**” above to display the desired reference waveform.
2. Press the **Scale** and **Position** softkey and turn the universal knob to adjust the vertical scale and position of the reference waveform. The vertical scale and position information displays in the middle of the screen.

The initial values displayed in the middle of the screen is the setup that was saved with the reference waveform.

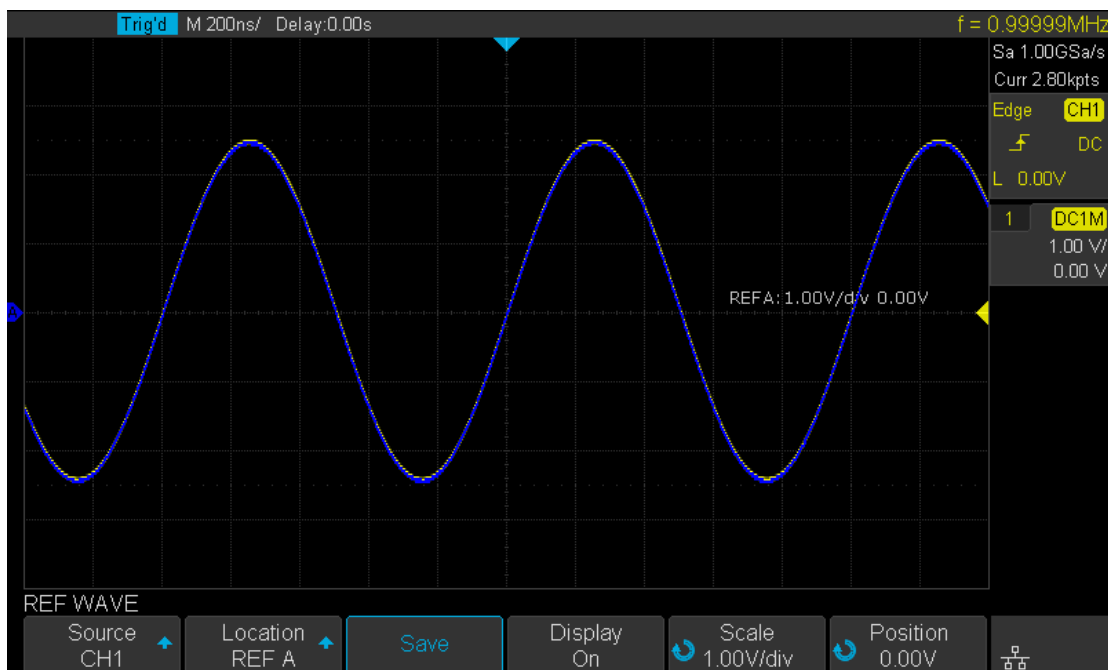

Figure 57 Reference Waveform

Note: Only the vertical Variable knob and the vertical Position knob work for the reference waveform and the math waveform.

To Clear the REF Waveform Display

The oscilloscope does not have the “Clear” option under the REF WAVE function menu. To clear the appointed reference waveform, you can save a new reference waveform to the same location to replace it.

To Make a Math Operation

The oscilloscope supports many math operations between analog channels including addition (+), subtraction (-), multiplication (*), division (/), FFT, differential (d/dt), integral ($\int dt$), square root ($\sqrt{\quad}$). The resulting math waveform is displayed in white and labelled with "M". You can use cursors to measure it.

The contents of this chapter:

- ◆ Units for Math Waveforms
- ◆ Math Operators
- ◆ To Adjust the Math Waveform Scale and Offset

Note: if the analog channel or the math function is clipped (waveforms are not completely displayed on the screen), then the resulting math will also be clipped.

Units for Math Waveforms

Use the channel function menu to set the unit of each channel to "V" or "A". The oscilloscope math operation includes units as below:

Math Operation	Unit
Addition (+)or subtraction (-)	V, A
multiplication (*)	V ² , A ² or W (Volt-Amp)
division (/)	None or S
FFT	dBVrms, Vrms, dBm, dBArms, Arms
differential (d/dt)	V/S or A/S (V/second or A/second)
integral ($\int dt$)	V/S or A/S (V/second or A/second)
square root ($\sqrt{\quad}$)	V ^{1/2} or A ^{1/2}

Math Operators

The oscilloscope supports math count operation (Addition, subtraction, multiplication, division), FFT (Fourier transform) operation and math function operation (differential, integral, square root).

Addition or Subtraction

Math operators perform arithmetic operations add or subtract operation on any two analog input channels. When you select addition or subtraction, the **Source A** and **Source B** values are added or subtracted point by point, and the result is displayed.

1. Press the **Math** button on the front panel to enter the MATH function menu.
2. Press the **Source A** and **Source B** softkey respectively, and then turn the **Universal Knob** to select the source to do math operation. Addition or Subtraction can be applied between Analog channels or between reference waveforms.
3. Press the **Operation** softkey and then turn the universal knob to select + or - to make an addition or subtraction operation. The resulting math waveform is displayed in white and labelled with "M".



Fig 58 Addition

4. If you want to invert the math waveform, press the **Invert** button and set the option to **On** to invert the display of the math waveform.

Multiplication and Division

There are Math operators to perform multiplication or division arithmetic operations on any two analog input channels. When you select multiplication or division, the **Source A** and **Source B** values are multiplied or divided point by point and the result is displayed.

1. Press the **Math** button on the front panel to enter the MATH function menu.
2. Press the **Source A** and **Source B** softkey respectively, and then turn the **Universal Knob** to select the source to do math operation. Multiplication or Division can be applied between Analog channels or between reference waveforms.
3. Press the **Operation** softkey and then turn the universal to select * or / to make multiplication or division operation. The resulting math waveform is displayed in white and labelled with "M".

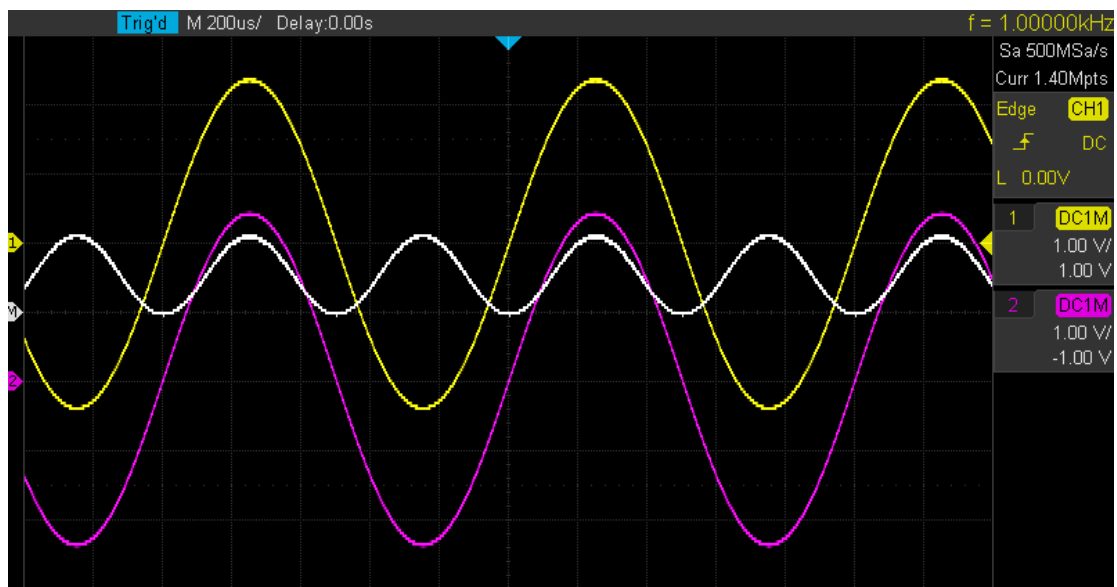

4. If you want to invert the math waveform, press the **Invert** button and set the option to **On** to invert the display of the math waveform.

FFT Operation

FFT is used to compute the fast Fourier transform using analog input channels. FFT takes the digitized time record of the specified source and transforms it to the frequency domain. When the FFT function is selected, the FFT spectrum is plotted on the oscilloscope display as magnitude in dBV versus frequency. The readout for the horizontal axis changes from time to frequency (Hertz) and the vertical readout changes from volts to dB.

Typically FFT operation can be used for the following:

- ◆ Measure harmonic components and distortion in the device under test
- ◆ Measure the characteristics of the noise in DC power
- ◆ Analyze vibration

To display an FFT waveform:

1. Press the **Math** button on the front panel to open the MATH function menu.
2. Press the **Operation** softkey and then turn the **Universal Knob** to select **FFT**. The resulting math waveform is displayed in white and labeled with “M”.
3. Press the **Source** softkey, and then turn the **Universal Knob** to select the source to do an FFT operation. Analog channels can be used as the source.
4. Press the **Window** softkey, and then turn the **Universal Knob** to select an appropriate window.

Spectral leakage can be considerably decreased when a window function is used. The oscilloscope provides five windows (Rectangle, Blackman, Hanning, Hamming and Flattop) which have different characteristics and are applicable to measure different waveforms. You need to select the window function according to different waveforms and their characteristics. Please read the table below carefully to make an appropriate option choice according to the input signal.

Window	Applications and Characteristics
Rectangle	This is normally used when the signal is transient (completely contained in the time-domain window) or known to have a fundamental frequency component that is an integer multiple of the fundamental frequency of the window. Signals other than these types will show varying amounts of spectral leakage and scallop loss, which can be corrected by selecting another type of window
Hanning	Reduced leakage and improve amplitude accuracy. Frequency resolution is also reduced.
Hamming	Reduce leakage and improve amplitude accuracy. Frequency resolution is also reduced.
Flat Top	This window provides excellent amplitude accuracy with moderate reduction of leakage, but with reduced frequency resolution.
Blackman	Leakage is reduced to a minimum, but with reduced frequency resolution.

5. Press the **Center** softkey, and then turn the **Universal Knob** to select the desired center frequency.
6. Press the **Hz/div** softkey, and then turn the **Universal Knob** to select the desired resolution frequency.
7. Press the **Scale** softkey, and then turn the **Universal Knob** to select the desired vertical FFT scale
8. Press the **Ref Level** softkey, and then turn the **Universal Knob** to select the desired vertical FFT offset.
9. Press the **Unit/Load** softkey to enter Unit/Load menu. Press **Unit** softkey to select the unit of vertical axis. The units of the vertical axis can be dBVrms, dBm or Vrms which use a logarithmic scale or a linear scale to display vertical amplitude respectively. If you need to display the FFT frequency spectrum in a relatively larger dynamic range, dBVrms is recommended. Press **Ext Load** softkey, and then turn the **Universal Knob** to select the external load value.

10. Press the **Display** softkey to select **Split**, **Full Screen** or **Exclusive** display mode.
 - **Split:** the source channel and the FFT operation results are displayed separately. The time domain and frequency domain signals are displayed clearly.
 - **Full Screen:** the source channel and the FFT operation results are displayed in the same window to view the frequency spectrum more clearly and to perform more precise measurements.
 - **Exclusive:** the waveforms of channels are disabled, only the FFT operation results are displayed in the window to view the frequency spectrum more clearly and to perform more precise measurements.

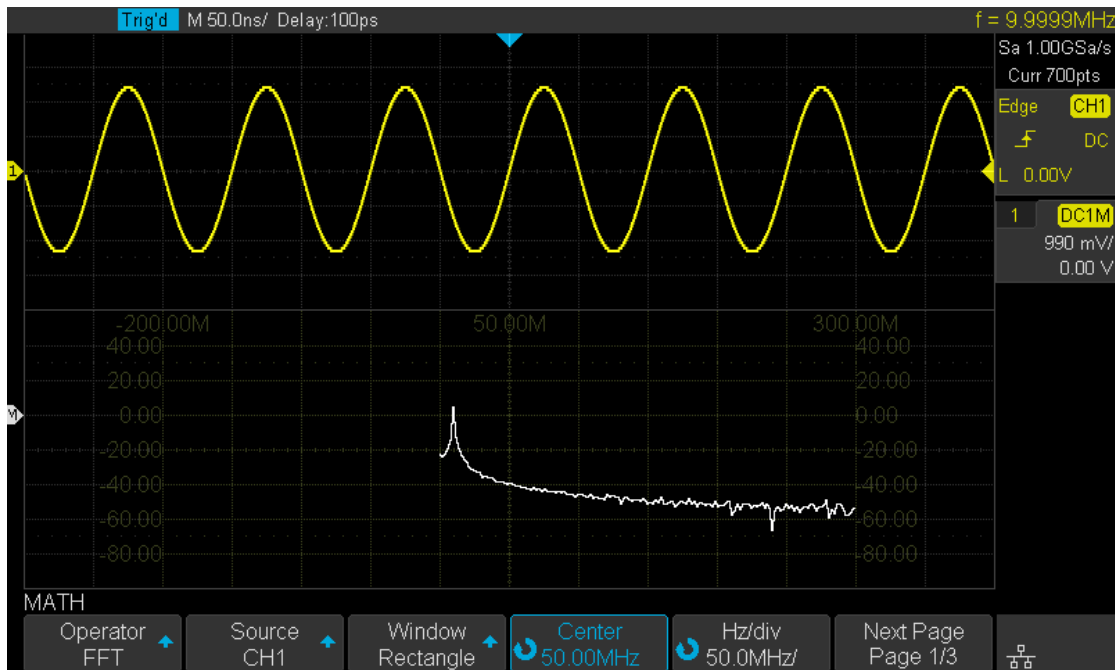

Figure 59 FFT Waveform in Split Mode

11. Press the **Max Points** softkey to select the maximum number of points which are used to compute the FFT waveform.
12. Press the **Autoset** softkey to automatically set the appropriate parameters for the FFT measurement.
13. Press the **Max-Hold** softkey to turn on or turn off the Max Hold function.

Note:

- Signals with DC components or deviation would cause error or deviation of the FFT waveform components. To reduce the DC components, set the Channel **Coupling** to **AC**.
- To reduce the random noise and aliasing frequency components of repetitive or single pulse, set the **Acquisition** of the oscilloscope to **Average**.

To measure FFT waveform:

To make cursor measurements, press the **Cursors** button, and then press the **Mode** softkey to select **On** to turn the cursors on. Use the X1 and X2 cursors to measure frequency values and the difference between two frequency values (ΔX). Use the Y1 and Y2 cursors to measure amplitude in dB and difference in amplitude (ΔY). You can find the frequency value at the first occurrence of the waveform maximum by using the X at Max Y measurement.

Note: please refer to the cursors chapter to understand how to use the cursors.

Math Function Operation

The oscilloscope supports math function operation including differential (d/dt), integral ($\int dt$) and square root ($\sqrt{\quad}$).

Differentiate

d/dt (differentiate) calculates the discrete time derivative of the selected source.

$$d_i = \frac{y(i + \Delta t) - y(i - \Delta t)}{2 \Delta t}$$

Where:

- d = differential waveform.
- y = channel 1, 2, 3, or 4 data points.
- i = data point index
- Δt = point- to- point time difference.

The **dx** option under d/dt math function operation menu shows the point- to- point time difference, and it ranges from 0.02div to 0.40div. "div" indicates the number of the pixel points that each division has. The oscilloscope has 50 pixel points per division. Take 0.2div as an example: $0.2 * 50 = 10$. It means to calculate the ten point's discrete time derivative of the selected source, and the Δt is the ten point's point- to- point time difference.

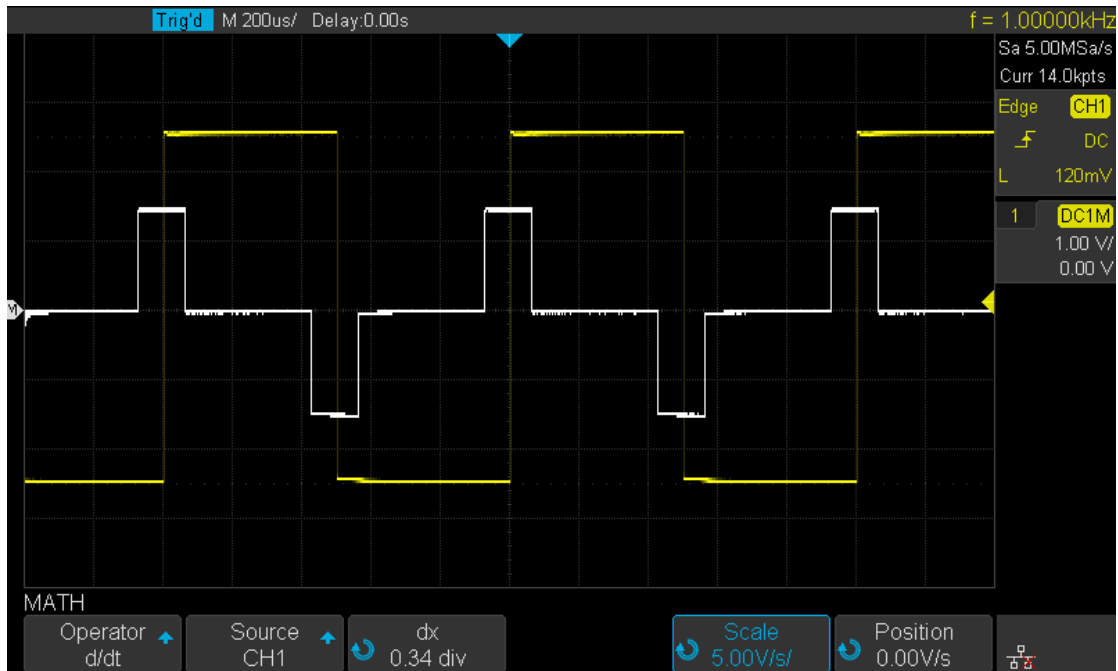

Figure 60 Differential Function Operation

You can use differentiate to measure the instantaneous slope of a waveform. For example, the slew rate of an operational amplifier may be measured using the differentiate function.

Note: Because differentiation is very sensitive to noise, it is helpful to set acquisition mode to **Average**.

Integrate

dt (integrate) calculates the integral of the selected source. You can use integrate to calculate the energy of a pulse in volt-seconds or measure the area under a waveform. dt plots the integral of the source using the "Trapezoidal Rule". The equation is:

$$I_n = c_0 + \Delta t \sum_{i=0}^n y_i$$

Where:

- I = integrated waveform;
- Δt = point- to- point time difference;
- y = channel 1, 2, or REFA,REFB
- c_0 = arbitrary constant;
- i = data point index;

The integrate operator provides an **Offset** softkey that lets you enter a DC offset correction factor for the input signal. Small DC offset in the integrate function input (or even small oscilloscope calibration errors) can cause the integrate function output to "ramp" up or down. This DC offset correction lets you level the integrate waveform.

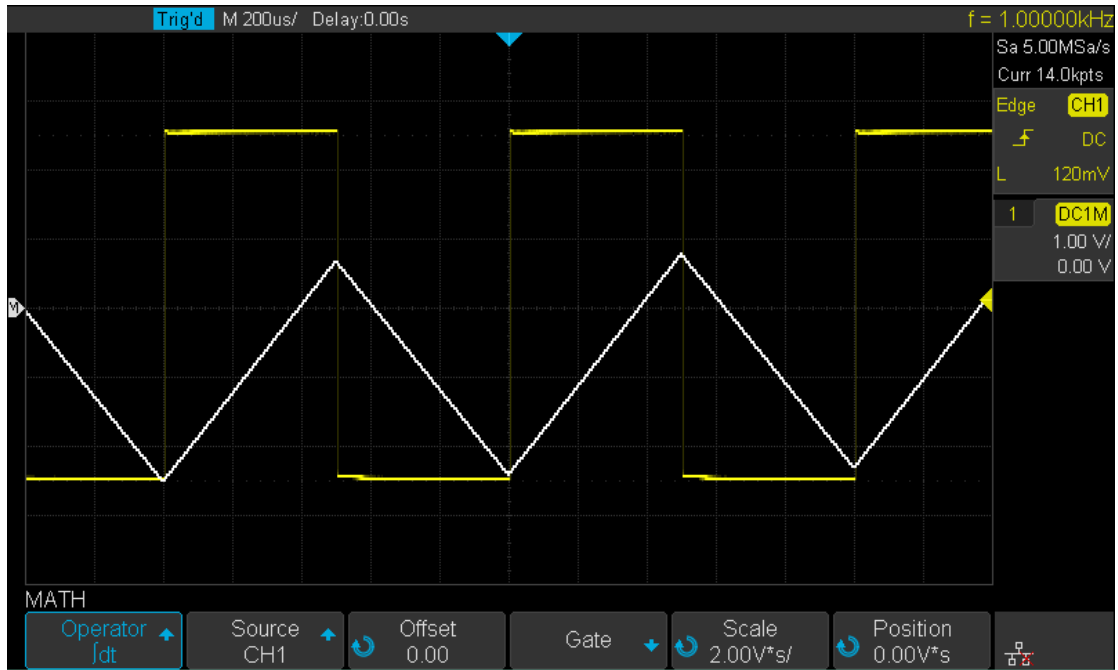

Figure 61 Integral without Offset

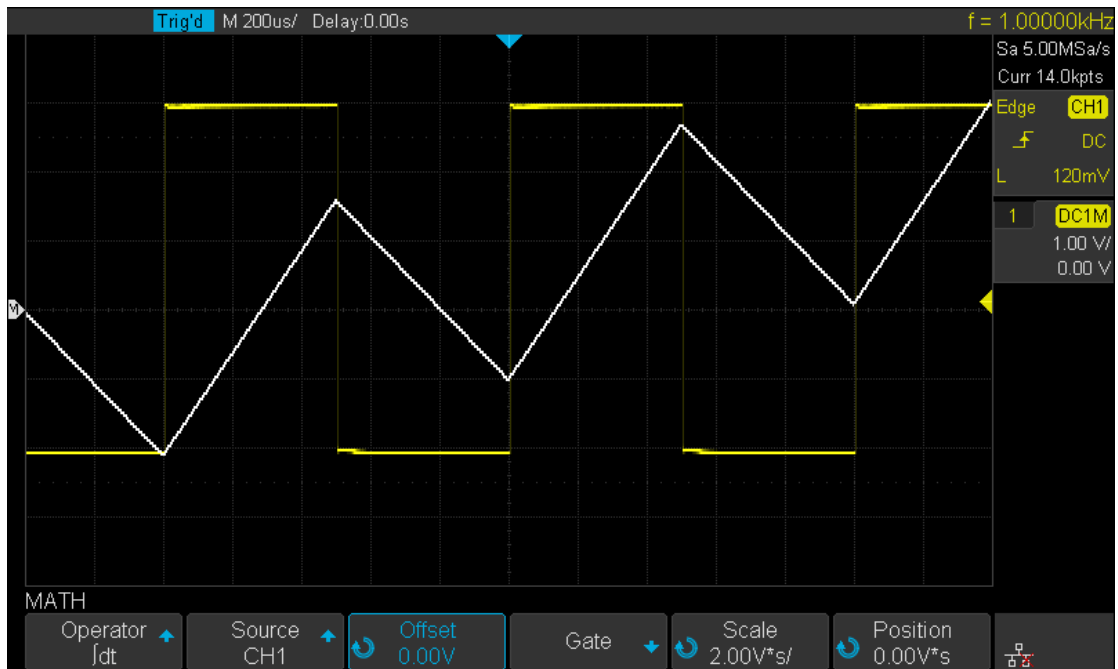

Figure 62 Integral with Offset

Square Root

Square root ($\sqrt{\quad}$) calculates the square root of the selected source.

Where the transform is undefined for a particular input, holes (zero values) appear in the

function output.

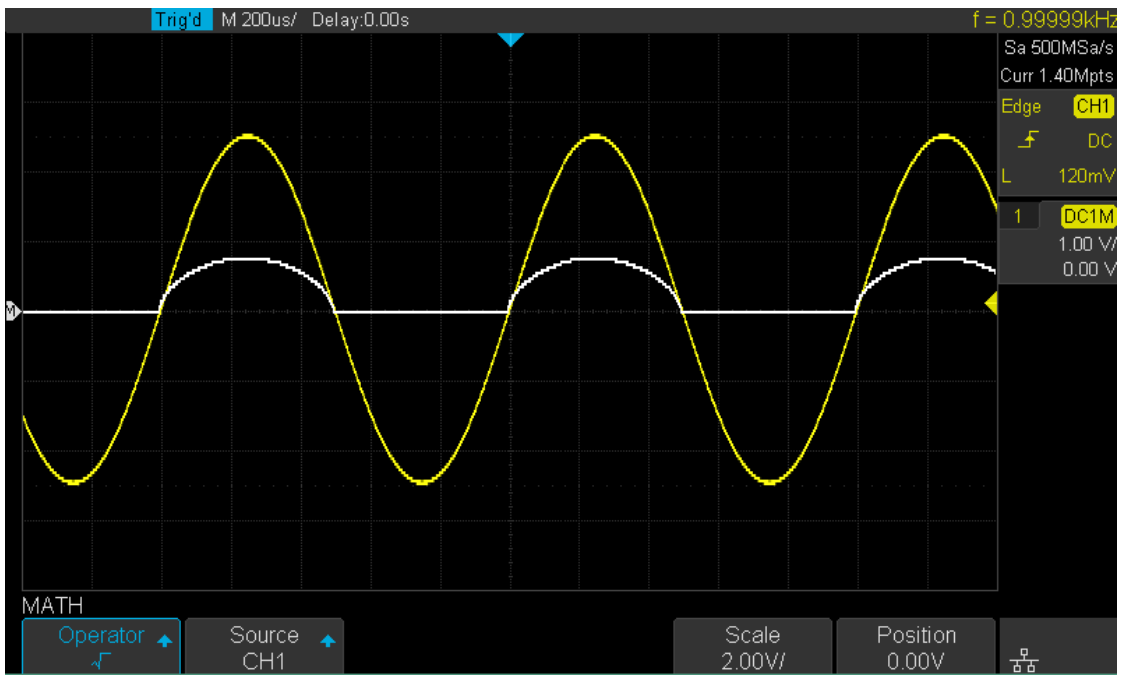

Figure 63 Square Root

To Make Cursors Measurements

Cursors are horizontal and vertical markers that indicate X- axis values and Y- axis values on a selected waveform source. You can use cursors to make custom voltage or time measurements on oscilloscope signals.

X Cursors

X cursors are vertical dashed lines that adjust horizontally and can be used to measure time (when the source is FFT waveform, X cursors measure frequency)

X1 cursor is the left (default position) vertical dotted line; it can be moved to any place of the screen.

X2 cursor is the right (default position) vertical dotted line; it can be moved to any place of the screen.

Use the **Universal Knob** to set the **X1** and **X2** cursor values. The values are displayed in the cursors box in the upper-left corner of the screen along with the difference between X1 and X2 (ΔT) and $1/\Delta T$.

When cursor type is set to **X2-X1**, use the **Universal Knob** will move the X1 and X2 cursors together. The value under the menu option is the difference between the X1 and X2 cursors.

Y Cursors

Y cursors are horizontal dotted lines that adjust vertically and can be used to measure voltage (V) or current (A). When the cursors source is the math function, the unit will match the math function.

Y1 cursor is the top (default position) horizontal dotted line; it can be moved to any vertical place of the screen.

Y2 cursor is the bottom (default position) horizontal dotted line; it can be moved to any vertical place of the screen.

Use the **Universal Knob** to set the Y1 and Y2 cursor values and the values are displayed in the cursors box in the top left corner of the screen along with the difference between Y1 and Y2 (ΔY).

When cursor type is set to **Y2-Y1**, use the **Universal Knob** will move the Y1 and Y2 cursors together. The value under the menu option is the difference between the Y1 and Y2 cursors.

To Make Cursor Measurements

1. Press the **Cursors** button on the front panel to enter the CURSOR function menu.
2. Press the **Mode** softkey and set the option to **On**.
3. Press the **Source** softkey, and then use the **Universal Knob** to select the desired source. Only analog channels, math waveforms and reference waveforms that are displayed are available for cursors.
4. To make cursor measurements:
 - To measure the horizontal time, use the **Universal Knob** to move the X1 and X2 cursors to desired place. If necessary, set the cursor type to **X2-X1**, move X1 and X2 cursors together.
 - To measure vertical voltage or current, use the **Universal Knob** to move the Y1 and Y2 cursors to desired place. If necessary, set the cursor type to “Y2-Y1”, move Y1 and Y2 cursors together.
 - To adjust the transparency of the cursors message box, press the **Display/Persist** softkey and go to the second page, press the **Transparence** (20% to 80%) softkey and then turn the **Universal Knob** to adjust the transparence to the desired value.

Cursor examples:

1. Use cursors to measure a pulse width:

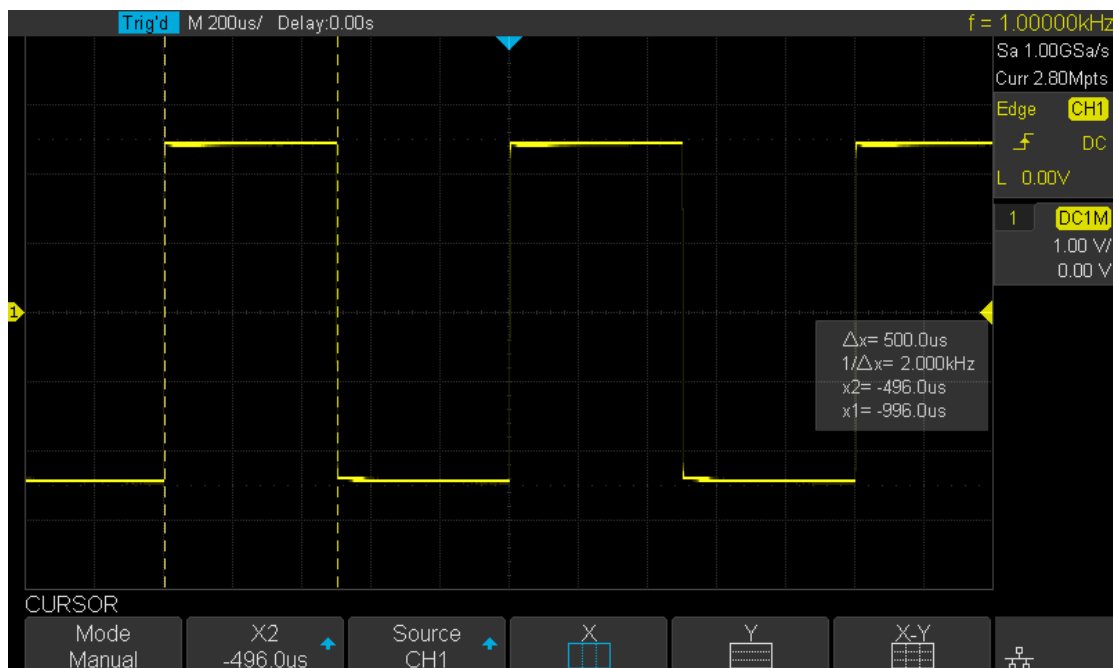

Figure 64 Measure Pulse Width

How To Make Automatic Measurements

The oscilloscope provides measurements of 36 waveform parameters and the statistics. It contains voltage, time and delay parameters.

Voltage and time parameters are under the Type option. The results of the last five selected measurements are displayed at the bottom of screen, above the menu. Delay parameters are under the **All Measure** submenu. Set the Delay option to On to display all the delay parameters.

The contents of this chapter:

- ◆ Type of measurements
 - Voltage Measurements
 - Time Measurements
 - Delay Measurements
- ◆ To make automatic measurement
- ◆ To clear measurements
- ◆ To make all parameters measurement

Type of Measurements

Voltage Measurements

Voltage measurements include 15 kinds of voltage parameter measurements.

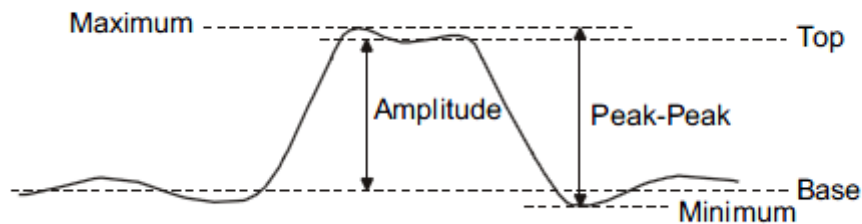

Figure 65 Voltage Measurements

1. **Pk-Pk:** Difference between maximum and minimum data values.
2. **Max:** Highest value in input waveform.
3. **Min:** Lowest value in input waveform.
4. **Ampl:** Difference between top and base in a bimodal signal, or between max and min in an unimodal signal.
5. **Top:** Value of most probable higher state in a bimodal waveform.
6. **Base:** Value of most probable lower state in a bimodal waveform.
7. **Cmean:** Average of data values in the first cycle.
8. **Mean:** Average of all data values
9. **Stdev:** Standard deviation of all data values
10. **Cstd:** Standard deviation of all data values in the first cycle
11. **Rms:** Root mean square of all data values.
12. **Crms:** Root mean square of all data values in the first cycle.
13. **Overshoot:** Overshoot is distortion that follows a major edge transition expressed as a percentage of Amplitude. ROV means rising edge overshoot and FOV means falling edge overshoot.

$$\text{Rising edge overshoot} = \frac{\text{local Maximum} - \text{D Top}}{\text{Amplitude}} \times 100$$

$$\text{Falling edge overshoot} = \frac{\text{Base} - \text{D local Minimum}}{\text{Amplitude}} \times 100$$

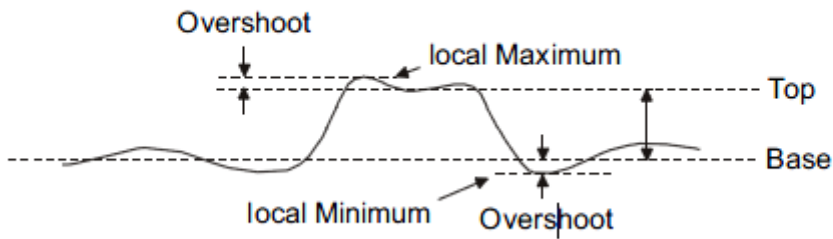

Figure 66 Overshoot

- 14. Preshoot:** Preshoot is distortion that precedes a major edge transition expressed as a percentage of Amplitude. The X cursors show which edge is being measured (edge closest to the trigger reference point).

$$\text{Rising edge preshoot} = \frac{\text{local Minimum} - \text{D Top}}{\text{Amplitude}} \times 100$$

$$\text{Falling edge preshoot} = \frac{\text{Base} - \text{D local Minimum}}{\text{Amplitude}} \times 100$$

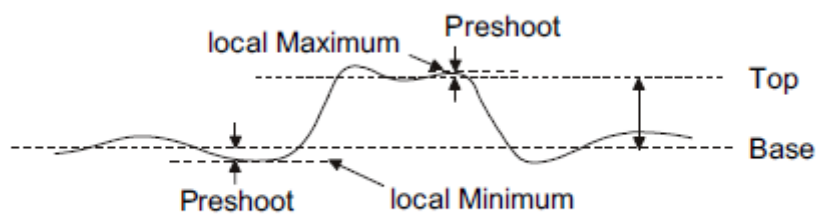

Figure 67 Preshoot

- 15. L@X:** the voltage value between the trigger point and the vertical position of the channel

Time Measurements

Time measurements include 9 kinds of time parameter measurements.

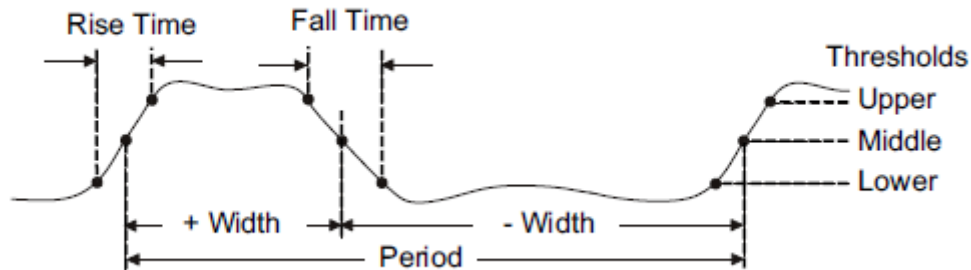

Figure 68 Time Measurements

1. **Period:** Period for every cycle in a waveform at the 50% level, using positive slope.
2. **Frequency:** Frequency for every cycle in a waveform at the 50% level, using positive Slope.
3. **+ Width:** Width measured at 50% level and positive slope.
4. **- Width:** Width measured at 50% level and negative slope.
16. **Rise Time:** Duration of rising edge from 10-90%.
5. **Fall Time:** Duration of falling edge from 90-10%.
6. **BWid:** Time from the first rising edge to the last falling edge, or the first falling edge to the last rising edge at the 50% crossing.
7. **+ Duty:** Ratio of positive width to period.
8. **- Duty:** Ratio of negative width to period.
9. **Delay:** Time from the trigger to the first transition at the 50% crossing.
10. **T@L:** Time from trigger of each transition at a specific level and slope, include: Current, Max, Min, Mean, Std-dev.

Delay Measurements

Delay measurements measure the time different between arbitrary two channels, including 9 kinds of delay measurements.

1. **Phase:** Calculate the phase difference between two edges.
2. **FRR:** Time between the first rising edges of the two channels.
3. **FRF:** Time from the first rising edge of channel A, to the first falling edge of channel B.
4. **FFR:** Time from the first falling edge of channel A, to the first rising edge of channel B.
5. **FFF:** Time from the first falling edge of channel A, to the first falling edge of channel B.
6. **LRR:** Time from the first rising edge of channel A, to the last rising edge of channel B.
7. **LRF:** Time from the first rising edge of channel A, to the last falling edge of channel B.
8. **LFR:** Time from the first falling edge of channel A, to the last rising edge of channel B.
9. **LFF:** Time from the first falling edge of channel A, to the last falling edge of channel B.

Automatic Measurements

Perform the steps below and select voltage or time parameters to make automatic measurements.

1. Press the **Measure** button on the front panel to enter the MEASURE function menu. The frequency and period will be enabled on the current trigger channel along with the statistics.
2. Press the **Source** softkey, and then use the **Universal Knob** to select the desired channel. Only analog channels that are displayed are available for measurements.
3. To select and display measurement parameters. Press the **Type** softkey, and then turn the **Universal Knob** to select the desired measurement parameter.
4. Press the **Universal Knob** to add the measurement parameter, the parameters and value will be shown above the menu, and the statistics status will update.
5. To turn off the statistic function, press the **Statistics** softkey to select **Off**.

The measurement display area can display 4 measurement parameters at most, and the measurements will display according to the selecting order. If a fifth measurement Parameter is added, the first measurement parameter will be deleted (FIFO).

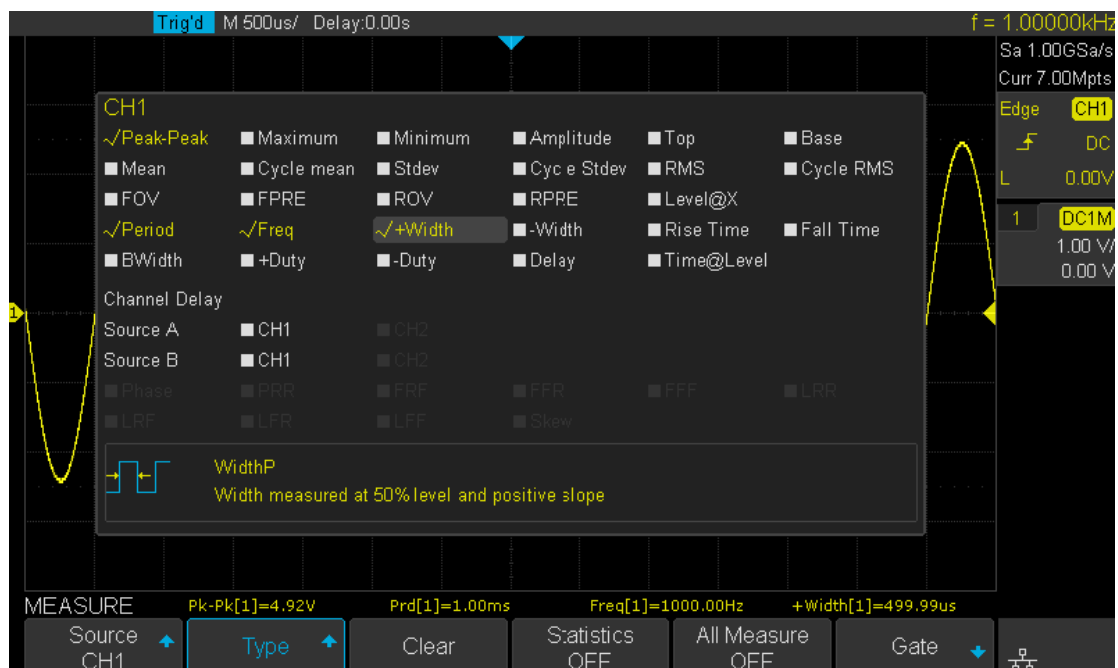

Figure 69 Select the Measurement Parameter

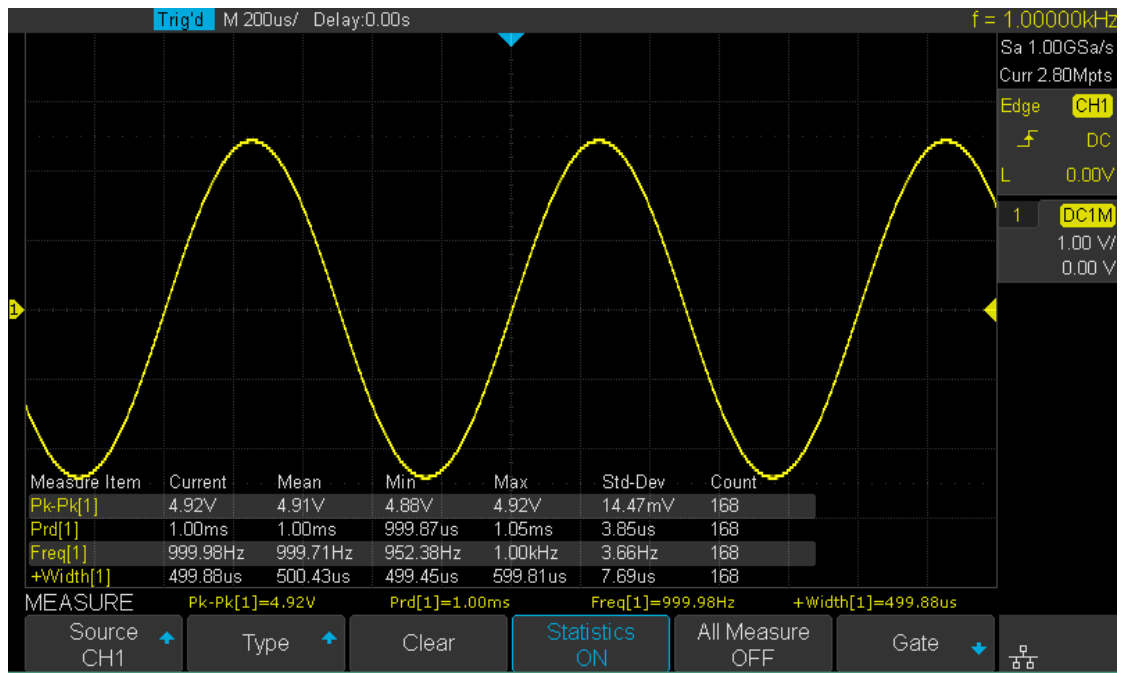

Figure 70 Added the Measurement

Note: if the parameter does not match the measure condition, it will display as "*****".

Clear Measurement Parameters

Press the **Clear** softkey to clear all the measurement parameters that are displaying on the screen.

To Make All Measurements

All measurements could measure all the voltage, time and delay parameters of the current measurement source and display the results on the screen.

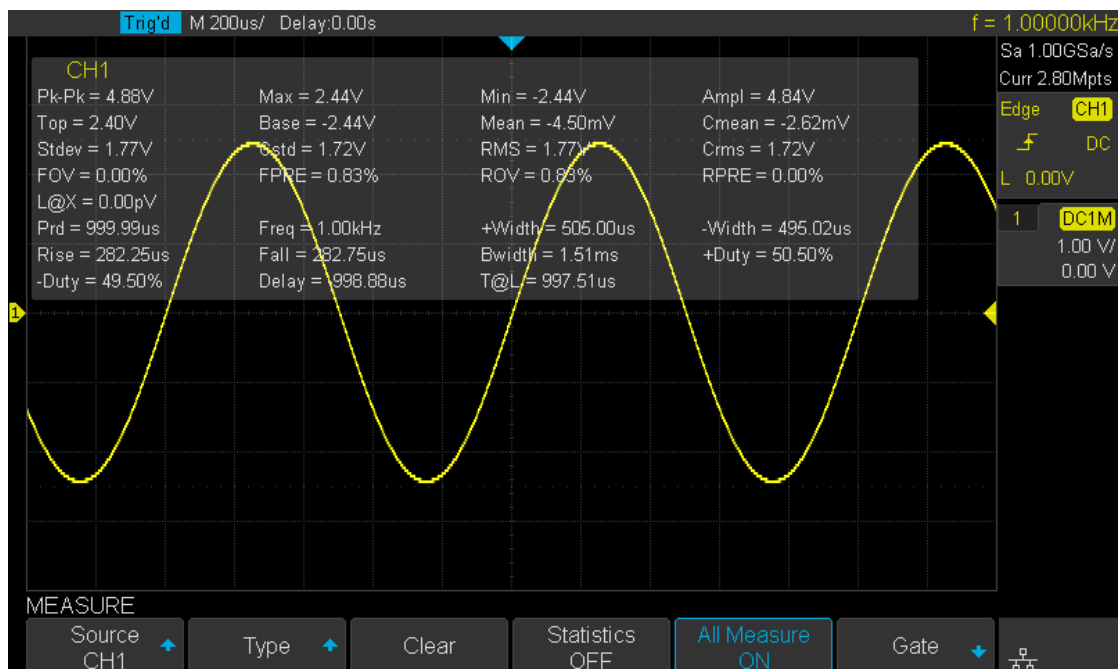

Figure 71 All Parameters Measurement

Do the following steps to make all parameters measurement.

1. Press the **Measure** button on the front panel to enter the MEASURE function menu.
2. Press the **All Measure** softkey to select **On**.
3. Press the **Source** softkey to select the measurement source.

Display Setting

You can set the display type, color, persistence, grid type, waveform intensity, grid brightness and transparence.

The contents of this chapter:

- ◆ To Set Display Type
- ◆ To Set Color Display
- ◆ To Set and Clear Persistence
- ◆ To Clear the Display
- ◆ To Select Grid Type
- ◆ To Adjust the Waveform Intensity
- ◆ To Adjust the Grid Brightness
- ◆ The Adjust the Transparence

To Set Display Type

Press the **Display** button on the front panel, and then press the **Type** softkey to select **Vectors** or **Dots** display type.

- **Vectors:** the sample points are connected by lines and displayed. Normally, this mode can provide the most vivid waveform to view the steep edge of a waveform (such as a square wave).
- **Dots:** displays only the sample points. You can directly view each sample point and use the cursor to measure the X and Y values of the sample points.

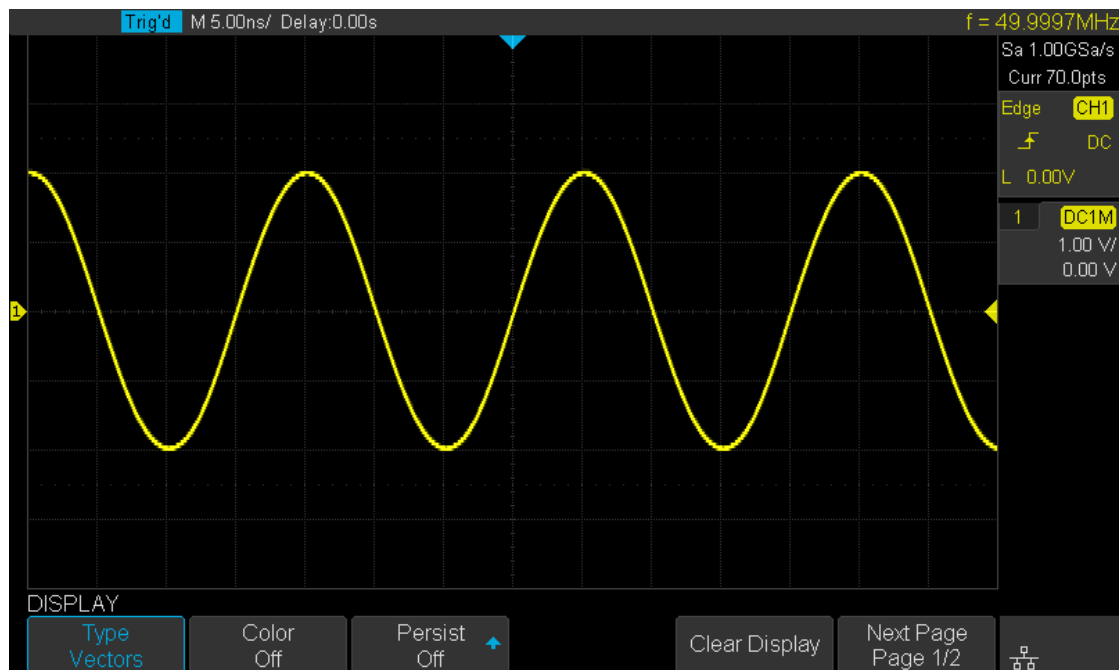

Figure 72 Vectors Display

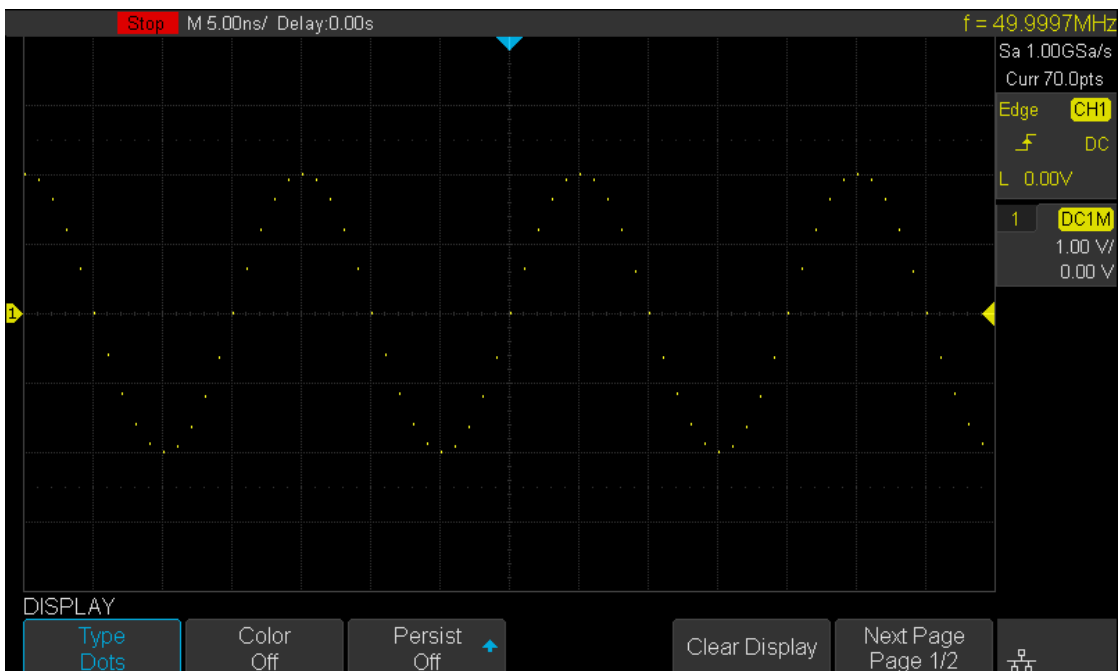

Figure 73 Dots Display

Set Display Color Temperature

Color temperature adopts the change of waveforms' color to reflect the change of the waveforms' appearance. The more frequently that the waveform appears, the warmer the color is; the less frequent the waveform appears, the colder the color is.

The picture below shows the change of color from cold to warm. Press the Display button on the front panel, and then press the **Color** softkey and set the option to **On** to turn on the color temperature function. You can compare the waveform's color with the picture below to understand the frequency that the waveform appears.

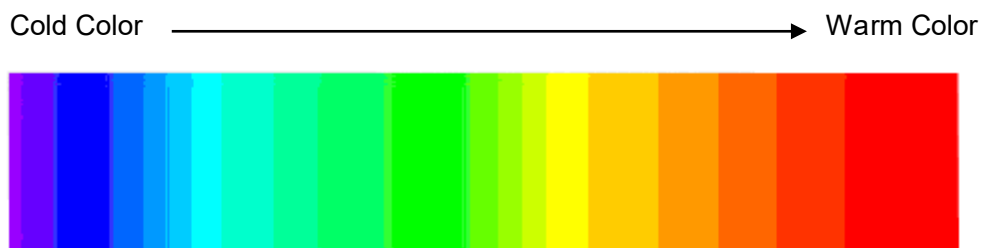

Figure 74 Color Temperature

To Set and Clear Persistence

With persistence, the oscilloscope updates the display with new acquisitions, but does not immediately erase the results of previous acquisitions. All previous acquisitions are displayed with reduced intensity. New acquisitions are shown in their normal color with normal intensity.

Do the following steps to set and clear persistence:

1. Press the **Display/Persist** button on the front panel to enter the DISPLAY function menu.
2. Press the **Persist** softkey; then turn the **Universal Knob** to select the desired option.
 - **Off** —turn off persistence.
 - Variable persistence time (1 second, 5 seconds, 10 seconds, 30 seconds) —select appropriate persistence time, the results of previous acquisitions are erased after the persistence time.
 - **Infinite** —select “Infinite”. Results of previous acquisitions are never erased. Use infinite persistence to measure noise and jitter, to see the worst- case extremes of varying waveforms, to look for timing violations, or to capture events that occur infrequently.

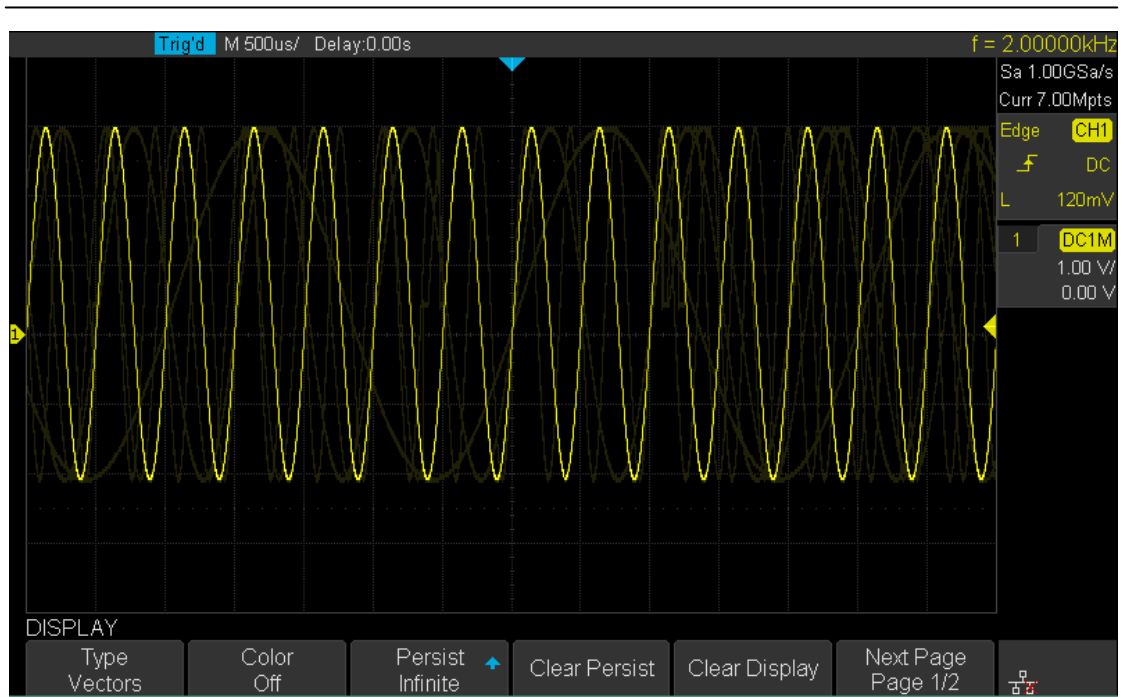

Figure 75 Persist Set to Infinite

3. When the **Persist** is **On**, to erase the results of previous acquisitions from the display, press the **Clear Persist** softkey. The oscilloscope will start to accumulate acquisitions again.
4. To return to the normal display mode, turn off persist and the previous acquisitions will be clear at once.

To clear the display



Press the Display button on the front panel to enter the DISPLAY function menu; press the **Clear Display** softkey to clear all the waveforms displaying on the screen and acquire new waveforms.

To Select Grid Type

To select grid type

1. Press the **Display/Persist** button on the front panel to enter the DISPLAY function menu.
2. Press the **Next Page** softkey to go to the second page of the Display function menu.
3. Press the **Grid** softkey; and then turn the **Universal Knob** to select the desired grid type. Press the **Grid** softkey continually can also select the grid type.

There are 3 kinds of grid types that are available. Select the grid type according to your needs.

-  Display 14x8 grid type
-  Display 2x2 grid type
-  Display without grid

To Adjust Waveform Intensity

Do the following steps to adjust waveform intensity:

1. Press the **Display/Persist** button on the front panel to enter the DISPLAY function menu.
2. Press the **Next Page** softkey to go to the second page of the Display function menu.
3. Press the **Intensity** softkey; and then turn the **Universal Knob** to select the desired value. The default value is 50%, and the range is from 0% to 100%.

Increasing the intensity lets you see the maximum amount of noise and infrequently occurring events. Reducing the intensity can expose more detail in complex signals.

Note: Waveform intensity adjustment affects analog channel waveforms only (not math waveforms, reference waveforms, digital waveforms, etc.).

To Adjust Grid Brightness

Do the following steps to adjust the grid brightness:

1. Press the **Display** button on the front panel to enter the DISPLAY function menu.
2. Press the **Next Page** softkey to go to the second page of the Display function menu.
3. Press the **Graticule** softkey; and then turn the **Universal Knob** to select the desired value. The default value is 40%, and the range is from 0% to 100%.

To Adjust Transparency

Transparency can be used to adjust the transparency of the message box of cursor, measure, Pass/Fail and all pop-up menus to an appropriate value to observe the data more conveniently.

Under Cursor or Measure or any other menu operation, if you want to change the transparency of the message box, do the following steps:

1. Press the **Display** button on the front panel to enter the DISPLAY function menu.
2. Press the **Next Page** softkey to go to the second page of the Display function menu.
3. Press the **Transparence** softkey; and then turn the **Universal Knob** to select the desired value. The default value is 80%, and the range is from 20% to 80%.

Save and Recall

Oscilloscope setups, waveforms, pictures, and CSV files can be saved to internal oscilloscope memory or to a USB storage device. The saved setups or waveforms can be recalled later. The oscilloscope provides a USB Host interface on the front panel to connect a USB device for external storage.

The contents of this chapter

- ◆ Save Type
- ◆ Internal Save and Recall
- ◆ External Save and Recall
- ◆ Disk Management

Save Type

The oscilloscope supports setups, waveforms, pictures and CSV files storage. The default save type is setups.

1. Setups

It's the default storage type of the oscilloscope. It saves the settings of the oscilloscope in internal or external memory in "*.SET" format. At most 20 setting files (from No.1~No.20) can be stored in internal memory. The stored settings can be recalled.

2. Reference

The oscilloscope saves the waveform data in external memory in "*.REF" format. At recall, the data will be displayed on the screen as REFA or REFB.

3. BMP

The oscilloscope saves the screen image to external memory in "*.bmp" format. You can specify the file name and saving directory under the same directory using the same file name. The recall of image the is not supported. The image is for use on an external PC.

4. JPG

The oscilloscope saves the screen image to external memory in "*.jpg" format. You can specify the file name and saving directory under the same directory using the same file name. The recall of the image is not supported. The image is for use on an external PC.

5. PNG

The oscilloscope saves the screen image to external memory in "*.png" format. You can specify the file name and saving directory under the same directory using the same file name. The recall of image is not supported. The image is for use on an external PC.

6. Binary

The oscilloscope saves the waveform data to external memory in "*.BIN" format. The data of all the channels turned on can be saved in the same file. The recall of binary data is not supported. The binary data file is for use on an external PC.

7. CSV

The oscilloscope saves the waveform data to external memory in "*.CSV" format. The stored files contain the waveform data of the displayed analog channels and the main setting information of the oscilloscope. The recall of CSV file is not supported. The CSV file is for use on an external PC.

Set the save type to **CSV**, and set the **Para Save** option to **On** or **Off** to turn on or of the parameters storage function.

8. Matlab

The oscilloscope saves the waveform data to external memory in “*.DAT” format. The data of all the channels turned on can be saved in the same file. The recall of Matlab file is not Supported. The data file is for use on an external PC.

9. The Default Key

The oscilloscope saves the factory config and config set by the user. Then you can recall the default factory config or user config.

Internal Save and Recall

Internal save and recall supports Setups in **Save/Recall**. In the following part, the save and recall method and procedures are introduced.

➤ **Save the specified oscilloscope setting in internal memory.**

1. Connect the signal to the oscilloscope and obtain a stable display.
2. Press **Save/Recall** button on the front panel to enter the SAVE/RECALL function menu.
3. Press the **Type** softkey and then turn the **Universal Knob** to select **Setups**; and then press the knob to confirm.
4. Press the **Save To** softkey to select **Internal** to save the current setup of the oscilloscope to the internal memory.
5. Press the **Setup** softkey button; and then turn the **Universal Knob** to select the location to save. The internal memory can save as many as 20 setup files, from No.1~No.20.
6. Press the **Save** softkey to save the current setup to the appointed location. After a few seconds the message "**Store Data success!**" will appear.

➤ **Load the specified type of file to internal memory.**

If you want to recall the setup after having finished the steps above, please do the following steps:

Press the **Setup** softkey, and then turn the **Universal Knob** to select the location that you want to recall, press the **Recall** softkey to recall the setup, and it will pop-up the message "**Read Data Success!**"

Note: if you need to delete a setup file in the memory, please save a new setup to the same location to overwrite it.

External save and recall

Before using external storage and recall, make sure that the USB flash device is connected correctly. External storage supports all the types of files in save, but in recall, **Picture** and **CSV** are not supported.

➤ **Save the specified type of file in the external USB flash device.**

1. Press the **Save/Recall** button on the front panel to enter the SAVE/RECALL function menu.
2. Press the **Type** softkey to select **Reference** or **Setup**
3. Press the **Recall** softkey to enter the SAVE/RECALL file system.

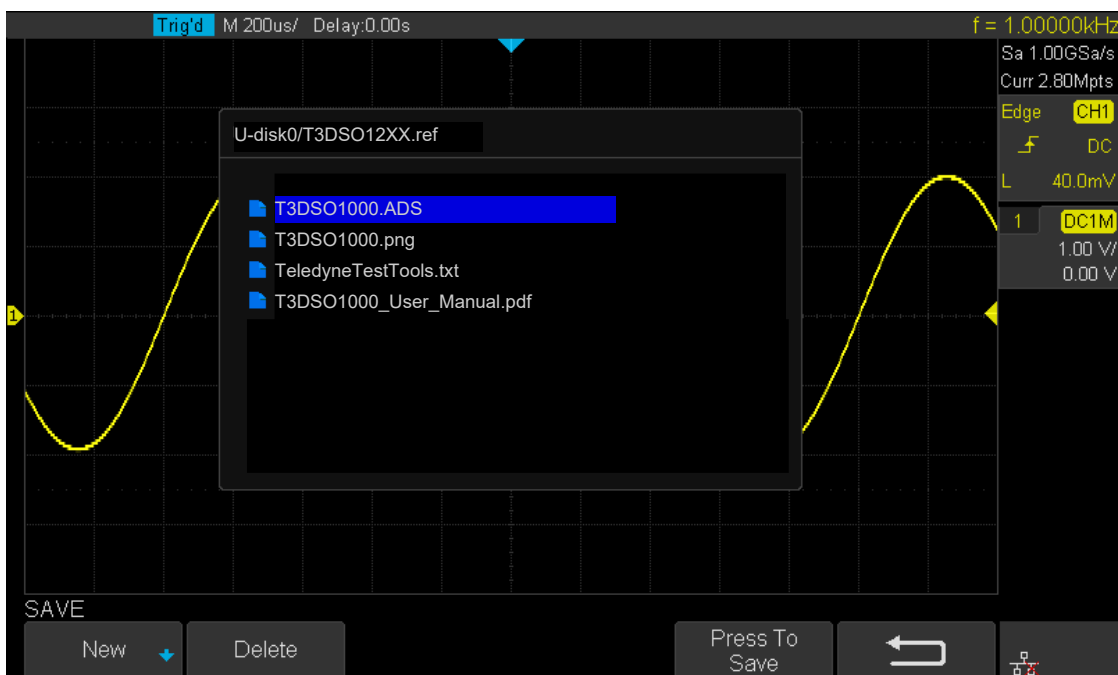

Figure 76 SAVE/RECALL File System

4. Use the **Universal Knob** to select the desired location. Files can be stored under the root directory or in a certain folder under the root directory of the USB storage device.

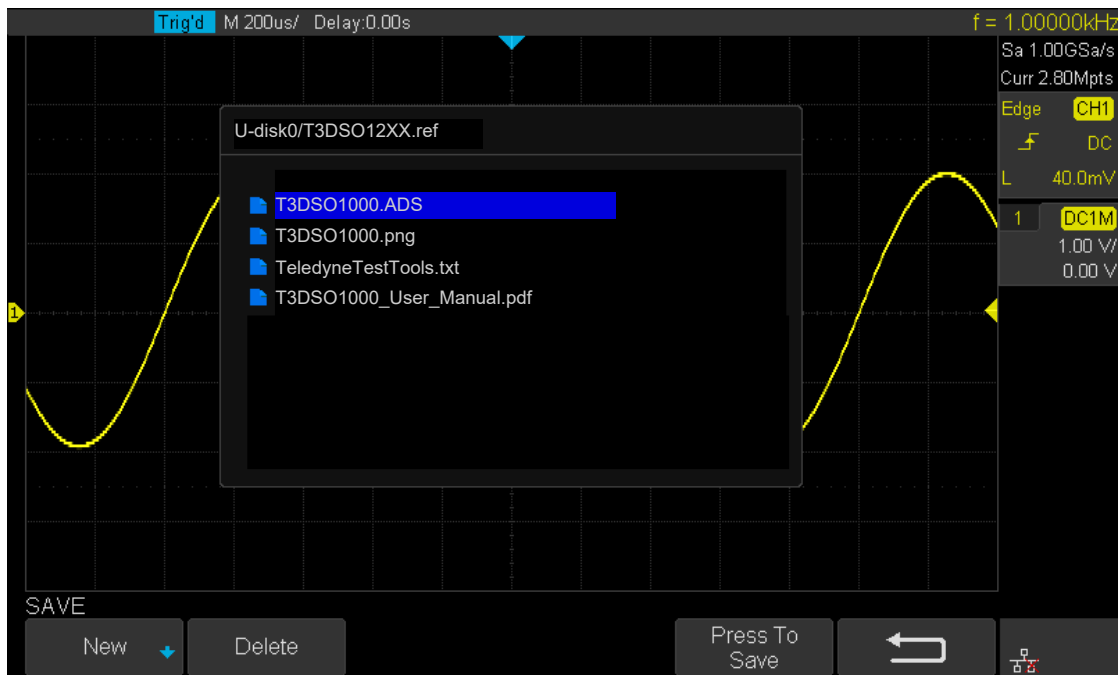

Figure 77 Select Save Location

5. After the save position is selected, press the **New** softkey to turn on the interface as shown in the figure below. Refer to the descriptions in **“To Create a new file or fold”** to create a new file name.

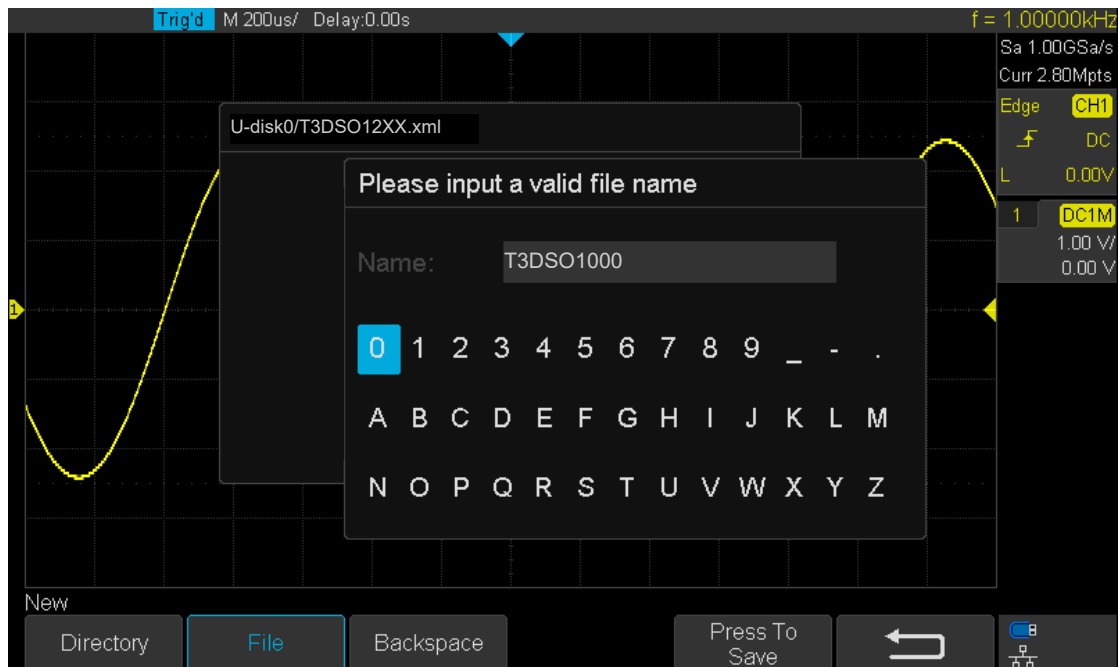

Figure 78 File Name Dialogue

6. Press the Enter softkey to save the current waveform to the external USB storage Device.

-
- **Load the specified type of file in the external USB storage device.**
7. Press the **Save/Recall** button on the front panel to enter the SAVE/RECALL function menu.
 8. Press the **Type** softkey to select **Waveforms** or **Setup**
 9. Press the **Recall** softkey to enter the SAVE/RECALL file system.
 10. Turn the **Universal Knob** to select the file to be recalled, press the **Load** softkey to recall the waveform or setup.

Disk Management

Disk management manages the save and recall operations once the oscilloscope is connected to a USB storage device. Before using USB storage, make sure that the USB storage device is connected correctly.

Execute the following operations through the disk management menu:

- ◆ To Create a New File or Folder
- ◆ To Delete a File or Folder
- ◆ To Rename a File or Folder

To Create a New File or Folder

This operation is only valid with external storage. The oscilloscope supports English. The file name or folder name can contain letters, numbers, underscores and spaces. Let's use an example to introduce how to create a file or folder.

Example: create a file or folder named "T3DSOab"

1. Press the **Save/Recall** button on the front to enter the SAVE/RECALL function menu.
2. Press the **Save** softkey, and then turn the **Universal Knob** to select one of the type (if select **Setups**, please set the **Save To** option to **External**).
3. Press the **Save** softkey to enter the SAVE/RECAL file system.
Press the **New** softkey to open the interface shown as the picture below. It divides into two parts: name input area and keyboard area.

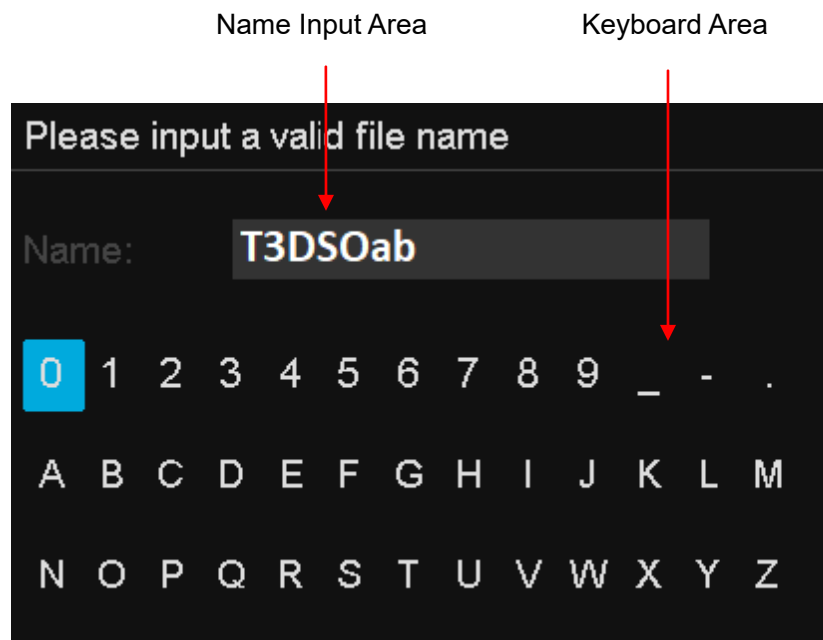

Figure 79 Input Keyboard

4. To delete the name in the name input area, press the **Backspace** softkey continuously to delete the characters one by one.

To delete a file or folder

This operation is only valid for external storage.

1. Press the **Save/Recall** button on the front to enter the SAVE/RECALL function menu.
2. Press the **Save** softkey, and then turn the **Universal Knob** to select one (if select Setups, please set the **Save To** option to **External**).
3. Press the **Save** or **Recall** softkey to enter the SAVE/RECAL file system.
4. Turn the **Universal Knob** to select the file or folder to be deleted, and then press the **Delete** softkey. Then the file or folder will be deleted.

Digital Channels (Option)

This chapter describes how to use the digital channels of a Mixed-Single Oscilloscope (MSO).

Note: The digital channel option is not available on the T3DSO1102 oscilloscope

This chapter contains the following items:

- ◆ To Connect the Digital Probes to the Device-under-test
- ◆ Acquiring Waveforms Using the Digital Channels
- ◆ To Change the Display Type of the Digital Channels
- ◆ To Switch a Single Channel On or Off
- ◆ To Switch All Digital Channels On or Off
- ◆ To Change the Logic Threshold for Digital Channels
- ◆ To Reposition a Digital Channel
- ◆ To Display Digital Channels as a Bus

To Connect the Digital Probes to the Device-under-test

1. If necessary, turn off the power supply to the device-under-test.
 - Turning off the power to the device-under-test prevents damage that might occur if you accidentally short lines together while connecting probes. You can leave the oscilloscope powered on because no voltage appears at the probes.
2. Connect one of the digital probe cable ports to the digital channels connector on the front panel of the T3DSO1000 series, and the other end to the digital channels connector of the digital probe.
 - The digital probe cable is keyed so you can connect it only one way. You do not need to power-off the oscilloscope.
3. Connect a flying lead to one of the digital probe ground pins, connect a grabber to the flying lead, and then connect the grabber to a ground trace/pin from the device-under-test.

The ground lead improves signal fidelity to the oscilloscope, ensuring accurate Measurements. It's good practice to connect several ground leads.
4. Connect a flying lead to one of the digital probe digital channel pins; connect a grabber to the flying lead, and then connect the grabber to a node in the circuit that you want to test.
5. Repeat step 4 until you have connected all points of interest.

Acquiring Waveforms Using the Digital Channels

Press the **Digital** button on the front panel to open the digital channels and start acquiring digital channel waveforms.

For digital channels, each time the oscilloscope takes a sample it compares the input voltage to the logic threshold. If the voltage is above the threshold, the oscilloscope stores a 1 in the sample memory; otherwise, it stores a 0.

To Change the Display Type of the Digital Channels

1. Press the **Digital** button on the front panel to open the DIGITAL function menu.



Figure 80 Digital Function Menu

2. Press the **Channel High** softkey to select **Low,Middle,High** display type.

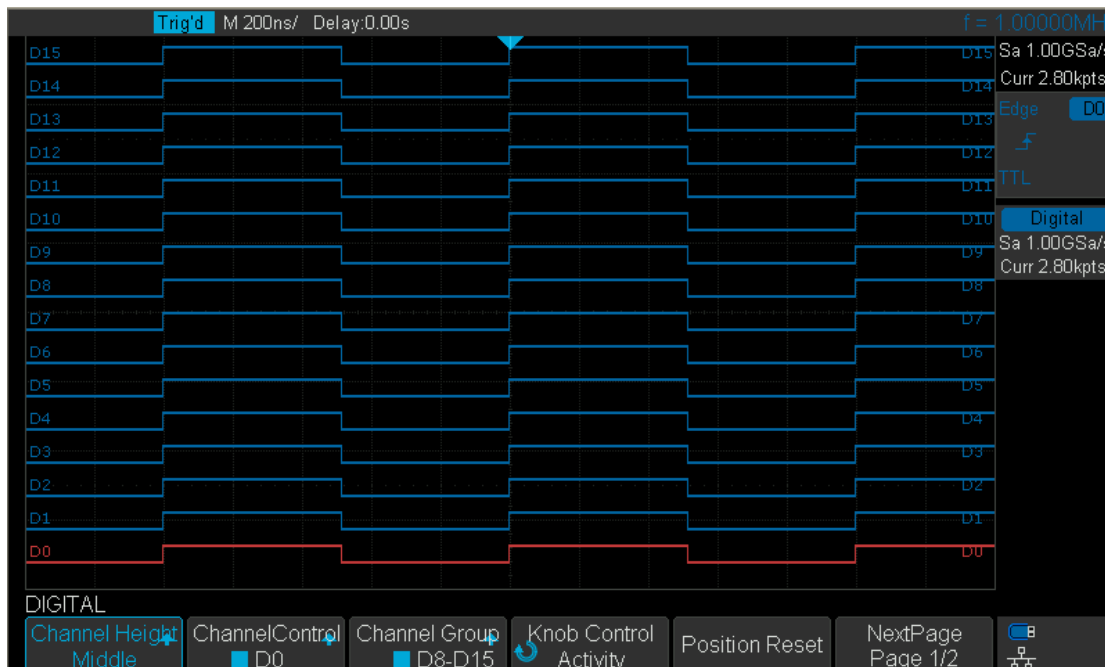

Figure 81 Digital Channel Height

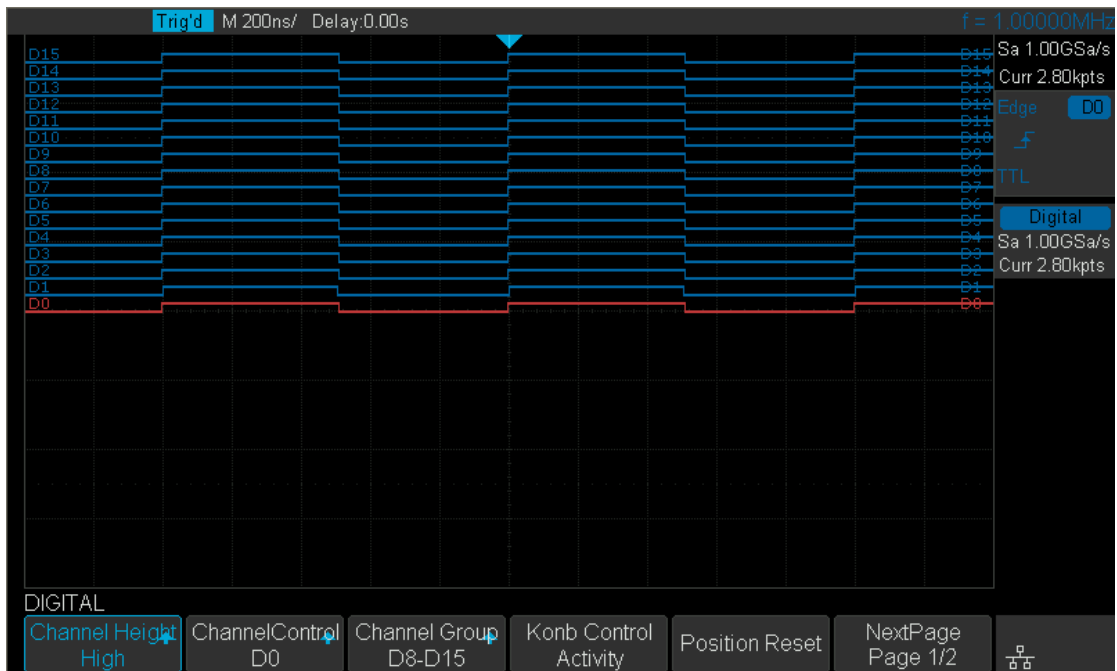

Figure 82 High Display Type

The display type control lets you spread out or compress the digital traces vertically on the display for more convenient viewing.

To Switch a Single Channel On or Off

1. Press the **Digital** button on the front panel to open the DIGITAL function menu.
2. Press the **ChannelControl** softkey, then turn the Universal Knob to select the desired channel such as **Dx** and push down the knob to confirm.
3. Press the **Dx** softkey to select **On** or **Off** to switch the selected channel on or off.

To Switch All Digital Channels On or Off

1. Press the **Digital** button on the front panel to open the DIGITAL function menu.
2. Press the **ChannelGroup** softkey to select **On** or **Off** to switch all digital channels in this group on or off.
 - Also, under the DIGITAL function menu, press the **Digital** button on the front panel to switch all digital channels off.

To Change the Logic Threshold for Digital Channels

1. Press the **Digital** button on the front panel to open the DIGITAL function menu.
2. Press the **Threshold** softkey to enter the THRESHOLDS menu.
3. Press the **D0~D7** or **D8~D15** softkey, then turn the **Universal Knob** to select a logic family preset or select Custom to define your own threshold.

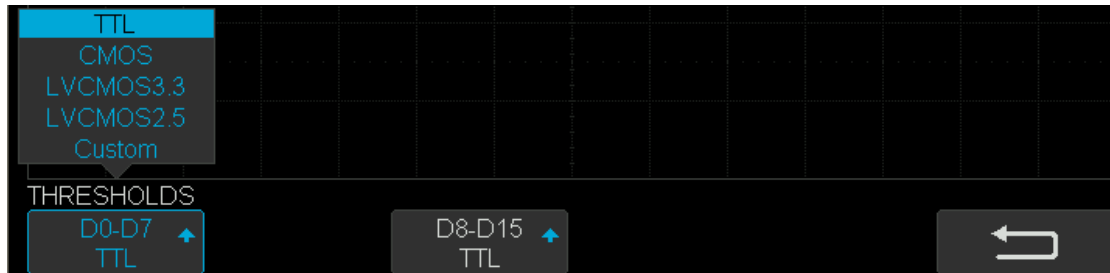

Figure 83 THRESHOLDS Function Menu

Logic Family	Threshold Voltage
TTL	1.5V
CMOS	1.65V
LVCMOS3.3	1.65V
LVCMOS2.5	1.25V
Custom	Variable from -3V to +3V

- The threshold you set applies to all channels.
- Values greater than the set threshold are high (1) and values less than the set threshold are low (0).
- If the **D0~D7** or **D8~D15** softkey is set to **Custom**, press the **Custom** softkey, then turn the **Universal Knob** to select the desired value and push the knob to confirm.

To Reposition a Digital Channel

1. Press the **Digital** button on the front panel to open the DIGITAL function menu and display the digital channel waveforms.
2. Press the **knob control softkey** then turn the **Universal Knob** to select the channel that you wish to reposition. The selected waveform is highlighted in red.
3. Turn the **Universal Knob** to move the selected channel position.

To Display Digital Channels as a Bus

Digital channels may be grouped and displayed as a bus, with each value displayed at the bottom of the display in hex or binary. You can create up to two buses.

To configure and display each bus, do the following steps:

1. Press the **Digital** button on the front panel to open the DIGITAL function menu and display the digital channel waveforms.
2. Press the **Digital Bus** softkey to enter the DIGITALBUS function menu.



Figure 84 DIGITALBUS Function Menu

3. Press the **Bus Select** softkey to select **Bus1** or **Bus 2**.
4. Press the **Display** softkey to select **On** to display the bus at the bottom of the display.
 - Under the DIGITAL function menu, press the **ChannelControl** softkey, turn the **Universal Knob** to make a selection such as **DX**, and then press the **Dx** softkey to select **On** or **Off** to set the channel to be included or excluded from the bus.
 - Under the DIGITAL function menu, press the **ChannelGroup** softkey to select **On** or **Off** to include or exclude all digital channels in this group.
 - Under the DIGITAL function menu, a status indicator is displayed in the status line at the bottom of the display. Light blue shows the digital channel is included in the bus while black shows it is excluded from the bus.
 - Under the DIGITAL function menu, press the **System Display** softkey to select **Binary** or **Hex** to display the bus values.
 - The Sampling rate of digital channels is displayed at the right of the display.

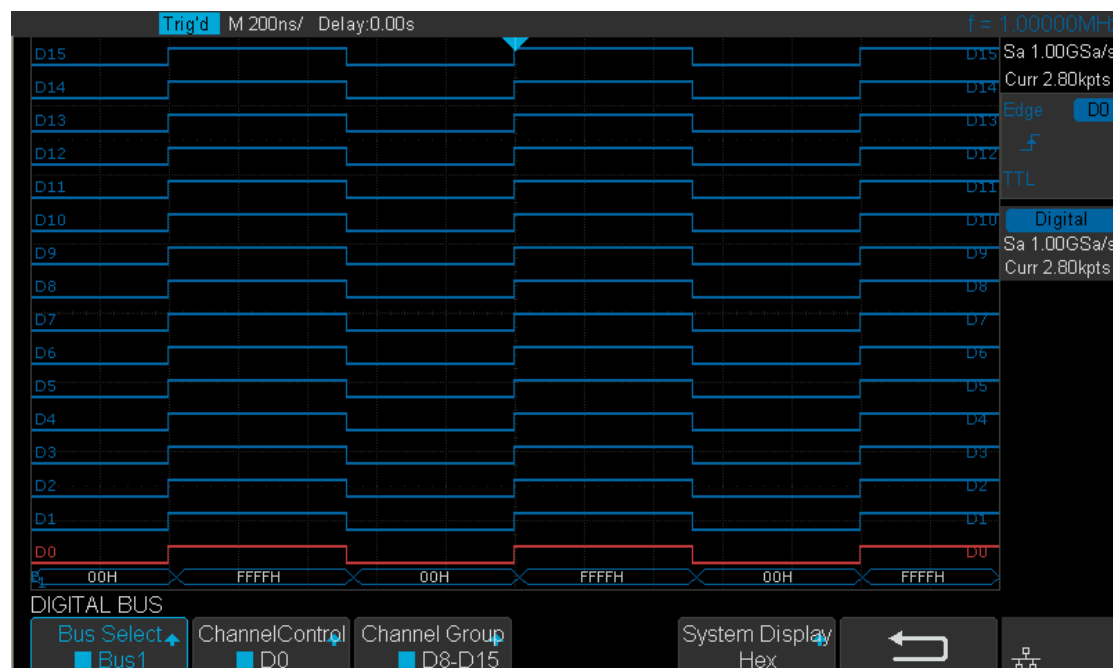

Figure 85 Digital Bus

System Function Setting

This function module supports the oscilloscope's system-related functions, such as system status, language, sound and some other advanced settings, such as self cal, update and remote interface configure.

The contents of this chapter:

- ◆ To View the System Status
- ◆ To Do Self Calibration
- ◆ IO Set
- ◆ To Enable or Disable the Sound
- ◆ To Specify the Language
- ◆ To Do Pass/Fail Test
- ◆ To Use the History Function
- ◆ To Print the Screen Image
- ◆ To Update Firmware or Configuration
- ◆ To Do Self Test
- ◆ To Specify the Screen Saver Time

To View the System Status

Do the following steps to view the system status:

1. Press the **Utility** button on the front to enter the UTILITY function menu.
2. Press the **System Status** softkey to view the system status of the oscilloscope. The system status includes the information below:
 - **Startup Times:** record the boot-strap times of the oscilloscope.
 - **Software Version:** list the current software version of the oscilloscope.
 - **Fpga Version:** list the current fpga version of the oscilloscope.
 - **Hardware Version:** list the current hardware version of the oscilloscope.
 - **Product Type:** display the product type of the oscilloscope.
 - **Serial NO.:** list the serial number of the oscilloscope.
 - **Scope ID:** display the scope identification of the oscilloscope.



Figure 86 System Status

3. Press the **Single** button on the front panel to exit.

To Do Self Calibration

The self-calibration program can quickly make the oscilloscope reach the best working state to get the most precise measurement values. You can perform self-calibration at any time especially when the environment temperature changes by more than 5 °C. Make sure that the oscilloscope has been warmed up or operated for more than 30 minutes before the self-calibration.

Do the following steps to do self calibration:

1. Disconnect all the input channels.
2. Press the **Utility** button on the front panel, and then press the **Do Self Cal** softkey, and the oscilloscope will show the message box shown as below:

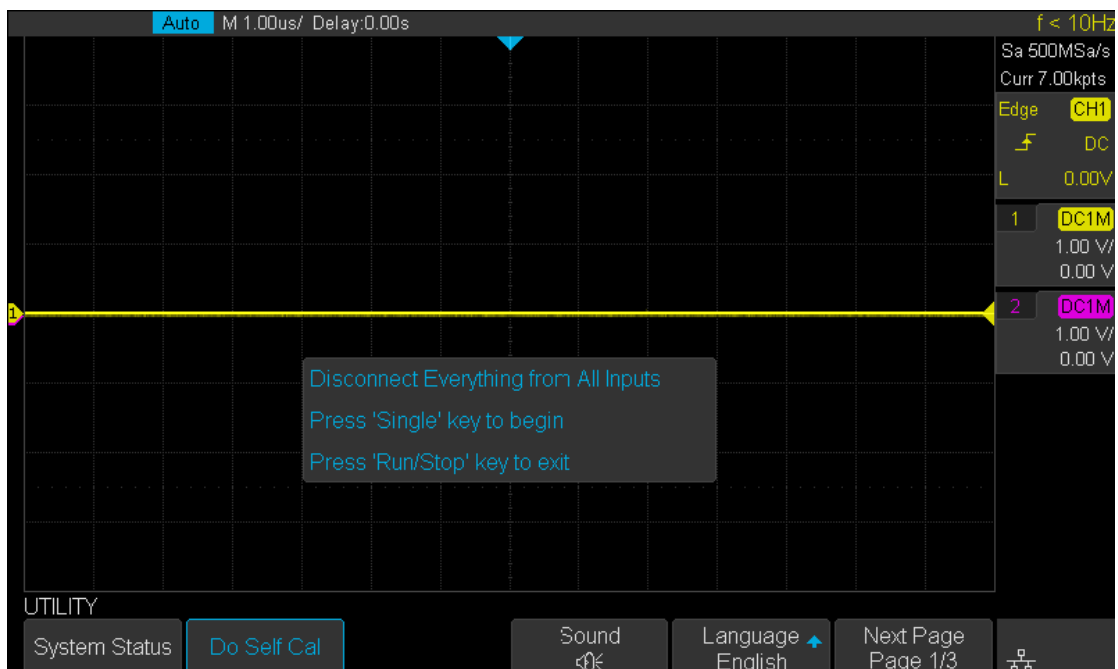



Figure 87 Do Self Cal

3. Press the **Single** button on the front panel to perform the self calibration program. During the calibration, most of the keys are disabled.
4. When the self calibration program is finished, it will display the message “**press Run/Stop key to exit**”. Press the **Run/Stop** button on the front panel to exit the calibration interface.

To Enable or Disable the Sound

When the sound is enabled, you can hear the sound of the beeper when you press a function key or a menu softkey or when the prompt message pops up.

Press the **Utility** button on the front panel to enter the UTILITY function menu; then press **Sound** softkey to select  or  to turn on or off the sound.

To Specify the Language

The oscilloscope supports multiple language menu, Chinese/English help and prompt messages.

1. Press **Utility** button on the front panel to enter the UTILITY Function menu.
2. Press the **Language** softkey; and then turn the **Universal Knob** to select the desired language. Then push the knob to select the language.

The languages that are currently available are Simplified Chinese, Traditional Chinese, English, French, German, Spanish, Russian, Italian, and Portuguese.

Pass/Fail Testing

One way to verify a waveform's compliance to a particular set of parameters is to use pass/fail testing. A pass/fail defines a region of the oscilloscope's display in which the waveform must remain in order to comply with chosen parameters. Compliance to the mask is verified point- by- point across the display.

The test results can be displayed on the screen as well as be indicated through the system sound or the pulse signal output from the **[TRIG OUT]** connector at the rear panel. Pass/Fail test operates on displayed analog channels; it does not operate on channels that are not displayed.

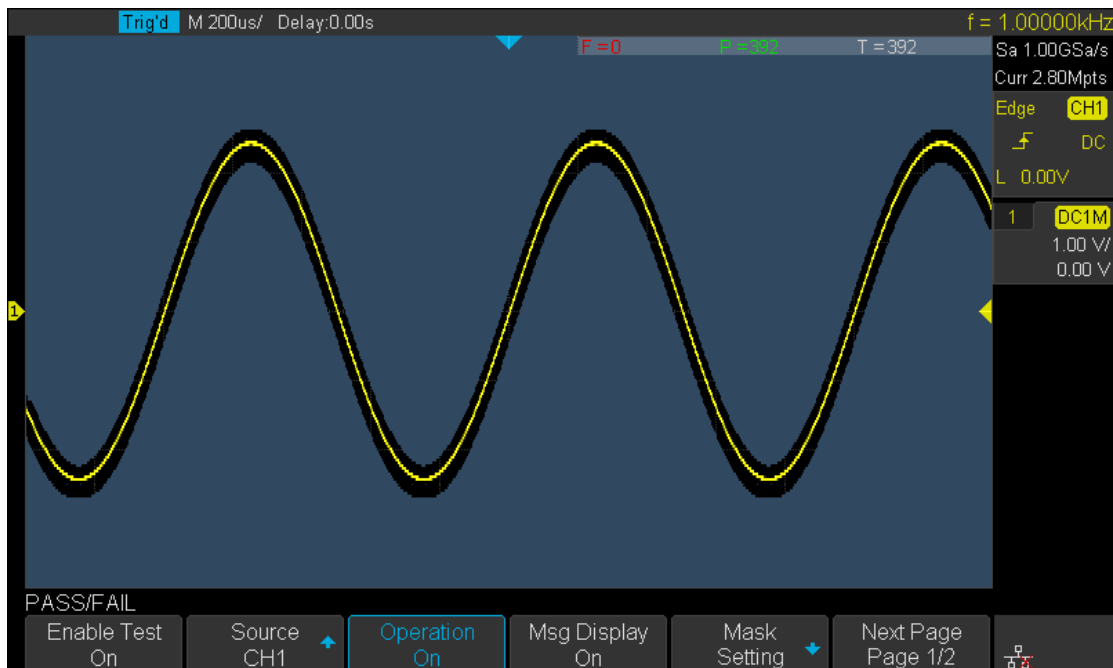





Figure 88 Pass/Fail Test

To Set and Perform Pass/Fail Test

Do the following steps to set and perform pass/fail test:

1. Press the **Utility** button on the front panel to enter the UTILITY function menu.
2. Press the **Next Page** softkey to go to the second page of the UTILITY function menu.
3. Press the **Pass/Fail** softkey to enter the PASS/FAIL function menu.
4. Press the **Enable Test** softkey to select **On** to enable the pass/ fail test.
5. Press the **Source** softkey to select the desired channel.
6. Press the **Mask Setting** softkey to enter the MASK function menu.
7. Press the **X Mask** or **Y Mask** softkey; and then turn the **Universal Knob** to select the desired value. The range is from 0.02div to 4div.
8. Press the **Create Mask** button to create the mask. Whenever the **Create Mask** softkey is pressed the old mask is erased and a new mask is created.
9. Press the **UP** softkey to return to the PASS/FAIL function menu.
10. Press the **Msg Display** to select **On** or **Off** to turn on or off the message display. When **On** is selected, the test result will be displayed in the upper-right message box of the screen.

F = 271 **P = 304** **T = 615**

- **Fail:** the number of waveforms that failed to match the mask (mask violation).
 - **Pass:** the number of waveforms within the mask.
 - **Total:** the total number of waveforms that have been acquired. The total of **Pass** and **Fail**.
11. Press the Next Page softkey to go to the second page of the PASS/FAIL function menu.
 12. Press the Fail softkey to select On or Off to turn on or off the function.
 - **On:** when failed waveforms are detected, the oscilloscope will stop the test and enter the STOP state. At this point, the results of the test remain on the screen (if the screen is turned on) and only one pulse is output from the **[TRIG OUT]** connector (if enabled) on the rear panel.
 - **Off:** the oscilloscope will continue with the test even though failed waveforms are detected. The test results on the screen will update continuously and a pulse will be output from the **[Trigger Out]** connector at the rear panel each time a failed waveform is detected.
 13. Press the Output softkey to turn on or off the sound.
 -  : When the failed waveforms are detected, the beeper sounds.
 -  : The beeper will not sound even if the failed waveforms are detected.
 14. Press the Next Page softkey to return to the first page of the PASS/FAIL function menu.
 15. Press the Operate softkey to perform the test.
 -  : Current state is stop; press the softkey to start the pass/fail test.
 -  : Current state is running; press the softkey to stop the pass/fail test.

Save and Recall Test Masks

Users can save the current test mask to the internal Flash memory or external USB flash device. The file format of the test mask file is “*.RGU”.

Save Test Mask to Internal Memory

1. Press the **Utility** button on the front panel to enter the UTILITY function menu.
2. Press the **Next Page** softkey to go to the second page of the UTILITY function menu.
3. Press the **Pass/Fail** softkey to enter the PASS/FAIL function menu.
4. Press the **Enable Test** softkey to select **On** to enable the pass/ fail test.
5. Press the **Source** softkey to select the desired channel.
6. Press the **Mask Setting** softkey to enter the MASK function menu.
7. Press the **X Mask** or **Y Mask** softkey; and then turn the **Universal Knob** to select the desired value.
8. Press the **Location** softkey to select **Internal**
9. Press the **Save** softkey to save the mask to internal memory.
10. A few second later the message “**Store Data Success!**” will be displayed.

Note: the internal memory can only save one test mask; saving a new test mask will erase the old one.

Recall Test Mask from Internal Memory

1. Press the **Utility** button on the front panel to enter the UTILITY function menu.
2. Press the **Next Page** softkey to go to the second page of the UTILITY function menu.
3. Press the **Pass/Fail** softkey to enter the PASS/FAIL function menu.
4. Press the **Enable Test** softkey to select **On** to enable the pass/ fail test.
5. Press the **Mask Setting** softkey to enter the MASK function menu.
6. Press the **Location** softkey to select **Internal**.
7. Press the **Load** softkey to recall the saved interval memory.
8. A few second later the message “**Read Data Success!**” will be displayed and the saved mask will be displayed on the screen.

Save Test Mask to External Memory

Do the following steps to save the test mask to external memory:

1. Press the **Utility** button on the front panel to enter the UTILITY function menu.
2. Press the **Next Page** softkey to go to the second page of the UTILITY function menu.
3. Press the **Pass/Fail** softkey to enter the PASS/FAIL function menu.
4. Press the **Enable Test** softkey to select **On** to enable the pass/ fail test.
5. Press the **Source** softkey to select the desired channel.
6. Press the **Mask Setting** softkey to enter the MASK function menu.
7. Press the **X Mask** or **Y Mask** softkey; and then turn the **Universal Knob** to select the desired value.
8. Press the **Location** softkey to select **External**
9. Press the **Save** softkey to enter the file SAVE/RECALL system.
10. Save the test mask file refer to the “**Save and Recall**” chapter.

Recall Test Mask from External Memory

Do the following steps to save the test mask f external memory:

1. Press the **Utility** button on the front panel to enter the UTILITY function menu.
2. Press the **Next Page** softkey to go to the second page of the UTILITY function menu.
3. Press the **Pass/Fail** softkey to enter the PASS/FAIL function menu.
4. Press the **Enable Test** softkey to select **On** to enable the pass/ fail test.
5. Press the **Mask Setting** softkey to enter the MASK function menu.
6. Press the **Location** softkey to select **External**.
7. Press the **Load** softkey to enter the file SAVE/RECALL system.
8. Select the desired test mask file with a RGU postfix using the **Universal Knob**; and then press the **Load** softkey.

Arbitrary Waveform Generator (Option)

The T3DSO1000 series support an external Arbitrary Waveform Generator (AWG), which can easily and quickly provide multiple output waveforms for users. The AWG provides two kinds of waveforms: the standard waveform and the Arb. The Arb waveform consists of two types: the system's built-in waveforms and the stored waveforms.

Built-in waveforms are stored in the internal non-volatile memory. It includes: Common, Math, Engine, Window, Trigo. Users may also edit the arbitrary waveforms using a PC, or import the waveforms from a USB disk that contains stored edited waveforms.

The AWG is ordered as software, via a software key code, and the generator hardware itself.

The software is ordered as T3DSO1000-FG for the T3DSO1104 and 1204, or ordered as T3DSO1000A-FG for the T3DSO1202A or T3DSO1302A.

The Function Generator (AWG) hardware is ordered as T3DSO1000-FGMOD-A.

The T3DSO1000-FGMOD and T3DSO1000-FGMOD-A have the same performance capability except that the -A version has an isolated output and is 20mm longer in length, being 161.95mm long. The -A version replaces and superceeds the non-A version. The non-A version is no longer available.

The T3DSO1000-FGMOD and T3DSO1000-FGMOD-A can be used interchangeably by any T3DSO1000 scope that has the -FG software license.

The isolated capability of the -A version is always on. There are no user controls or programming commands for the isolation functionality, it is always on.

The isolation specification for the T3DSO1000-FGMOD-A is maximum of 42 Vpk.

Note: Both the software key and hardware function generator hardware need ordering to to have a functioning AWG.

Note: The Arbitrary Waveform Generator option is not available on the T3DSO1102 oscilloscope

The contents of this chapter:

- ◆ AWG Menu Introduction
- ◆ AWG Introduction to the Waveform Selection
- ◆ AWG Function Setting
- ◆ AWG System Information
- ◆ AWG System Status and Firmware Upgrade
- ◆ AWG Remove Device

Output

Connect AWG with USB cable, and the oscilloscope interface indicates "AWG device connection success", Press the **Utility** → **Next Page4/4** → **AWG**, to enter the function menu interface of the AWG system as shown below, including: Output, Wave, Setting, System, Remove Device.



Figure 89 AWG Menu Interface

Press **Output** softkey to open or close the AWG output. When the output is on, the upper right corner of the oscilloscope interface will display the corresponding waveform frequency and amplitude information of AWG output wave.

Setting a Standard Waveform

1. To set standard waveform, sine wave example.

Press the **Utility** → **Next Page4/4** → **AWG** → **Wave**, Rotate the Universal knob to the Sine wave. Then press the knob to select the interface shown as below:

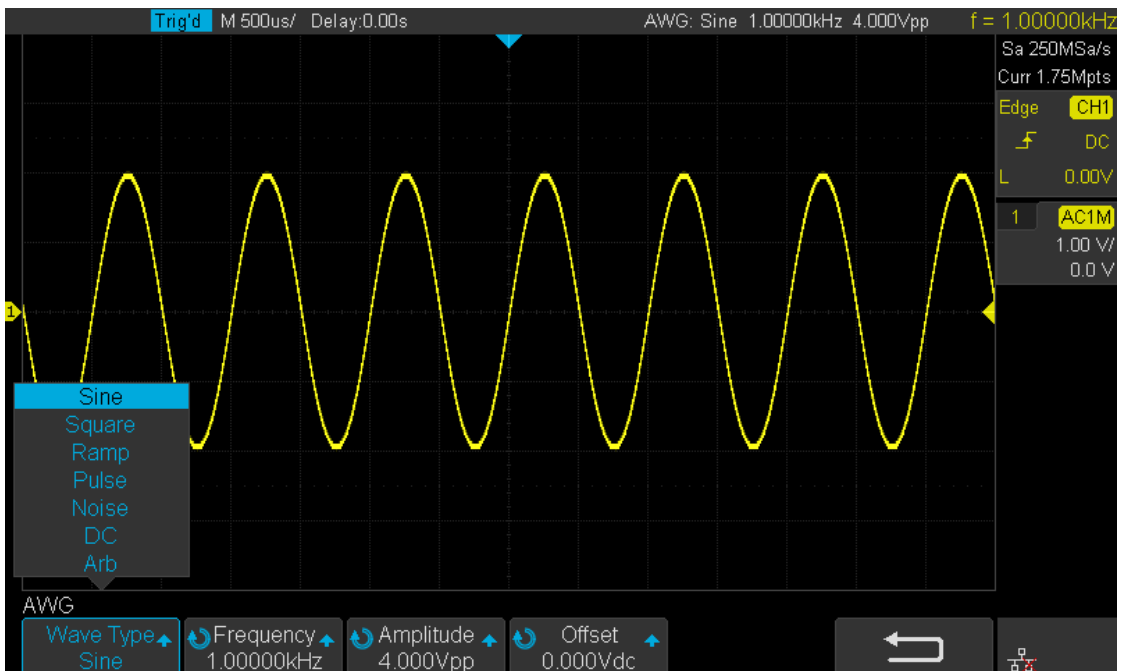

Figure 90 Wave Type Interface

- The following table shows the waveform type and its corresponding characteristics. Set the waveform parameters for the required waveform by using the universal knob and the menu system.

Amplitude and Offset values halve into 50 Ohm load.

Type	Character	Frequency Range	Amplitude (High-Z)	Offset (High-Z)
Sine	Use the Universal Knob to adjust the Frequency / Frequency Fine / Period / Period Fine / Amplitude / Amplitude Fine / High-Level / High-Level-Fine / Offset / Offset Fine / Low-Level / Low-Level-Fine value.	1uHz-25MHz	$\pm 2\text{mV} - \pm 3\text{V}$ ($4\text{mV}_{\text{pk-pk}} - 6\text{V}_{\text{pk-pk}}$)	$\pm 3.0\text{V}$
Square	Use the Universal Knob to adjust the Frequency / Frequency Fine / Period / Period / Fine / Amplitude / Amplitude Fine / High-Level / High-Level-Fine / Offset / Offset Fine / Low-Level / Low-Level-Fine / Duty value.	1uHz-10MHz	$\pm 2\text{mV} - \pm 3\text{V}$ ($4\text{mV}_{\text{pk-pk}} - 6\text{V}_{\text{pk-pk}}$)	$\pm 3.0\text{V}$
Ramp	Use the Universal Knob to adjust the Frequency / Frequency Fine / Period / Period Fine / Amplitude / Amplitude Fine / High-Level / High-Level-Fine / Offset / Offset Fine / Low-Level / Low-Level-Fine / Symmetry value.	1uHz-300KHz	$\pm 2\text{mV} - \pm 3\text{V}$ ($4\text{mV}_{\text{pk-pk}} - 6\text{V}_{\text{pk-pk}}$)	$\pm 3.0\text{V}$
Pulse	Use the Universal Knob to adjust the Frequency / Frequency Fine / Period / Period / Fine / Amplitude / Amplitude Fine / High-Level / High-Level-Fine / Offset / Offset Fine / Low-Level / Low-Level-Fine / Width / Width Fine value.	1uHz-10MHz	$\pm 2\text{mV} - \pm 3\text{V}$ ($4\text{mV}_{\text{pk-pk}} - 6\text{V}_{\text{pk-pk}}$)	$\pm 3.0\text{V}$
Noise	Use the Universal Knob to adjust the Stdev / Mean value.			
DC	Use the Universal Knob to adjust the Offset value.			$\pm 3.0\text{V}$
Arb	Use the Universal Knob to adjust the Frequency / Frequency Fine / Period / Period Fine / Amplitude / Amplitude Fine / High-Level / High-Level-Fine / Offset / Offset Fine / Low-Level / Low-Level-Fine value.			

3. How to setup an Arb waveform

Press the **Utility** → **Next Page4/4** → **AWG** → **Wave** then select the Arb, and it has two types:

Stored Arb:

Users can edit the Arb through a PC. Download the edited Arb to the instrument through the remote interface, or read from the U disk which has stored the Arb. Choose **Wave Type** → **Arb** → **Arb Type** → **Stored**, enter the Stored Arb interface and invoke the waveform in the external storage device.

Built_in Arb:

Choose **Wave Type** → **Arb** → **Arb Type** → **Built-in** to enter the following interface, Rotate the knob to move the cursor, press the knob to select to the desired waveform, and then return back to the Built-in waveform interface.



Figure 91 Built_in Arb interface

Setting



Figure 92 AWG Setting Interface

1. Output Load

Press **Utility** → **NextPage4/4** → **AWG** → **Setting** → **Output Load** to set **High-Z** or **50Ω**.

2. Sync Output

Press **Utility** → **NextPage4/4** → **AWG** → **Setting** → **Sync Output**, the AWG provides Sync output through the [Aux In/Out] connector on the rear panel. When the Sync Output is on, the port can output a CMOS signal with the same frequency as basic waveforms (except the Noise and DC), arbitrary waveforms, and modulated waveforms (except external modulation).

3. OVP(over voltage protection)

Press **Utility** → **NextPage4/4** → **AWG** → **Setting** → **OVP** to turn on or off the function. If the state is set to ON, overvoltage protection of AWG output port take effect once the condition is met (the absolute value of input voltage is higher than $4V \pm 0.5V$). When overvoltage protection occurs, a message will be displayed and the output is disabled.

4. Default

Press **Utility** → **NextPage4/4** → **AWG** → **Setting** → **Default** to recover the default values of the AWG (Sine, 1.000 KHz, 4.000Vpp, 0.0mVdc, High_Z, Sync output off, OVP On).

5. Zero Adjust

Press **Utility** → **NextPage4/4** → **AWG** → **Setting** → **Zero Adjust**. The AWG can be calibrated by using **Auto** mode or **Manual** mode. The method of AWG calibration is covered below.

Auto mode:

This mode can only be performed with the oscilloscope channel1. Connect the output of the AWG to the oscilloscope's channel1, press the Auto soft key, then the AWG starts automatic calibration, and displays "Zero Adjust Success!"

Manual mode:

The AWG can be manually calibrated through any channel on the oscilloscope. Take channel 2 as an example.

Connect the output of AWG to the oscilloscope's channel 2, turn on channel 2, and set DC coupling, no bandwidth limit, Probe is 1X.

Adjust the voltage of channel 2 channel to 1mv/div, and make the waveform visible in the oscilloscope interface, press the **Measure** and measure the mean value of channel 2. Press the **Manual** and rotate the knob to adjust the waveform, so that the mean value of the observed CH2 will be in the range of $\pm 1mv$, and then press the Save, the oscilloscope display " Zero Adjust Success! ".

Systems

1. System Status:

Press **Utility** → **NextPage4/4** → **AWG** → **System**, then select the System Status option to view the AWG's system information, including software version, hardware version, and serial number. After finished, press the return soft key to quit the interface of system information.

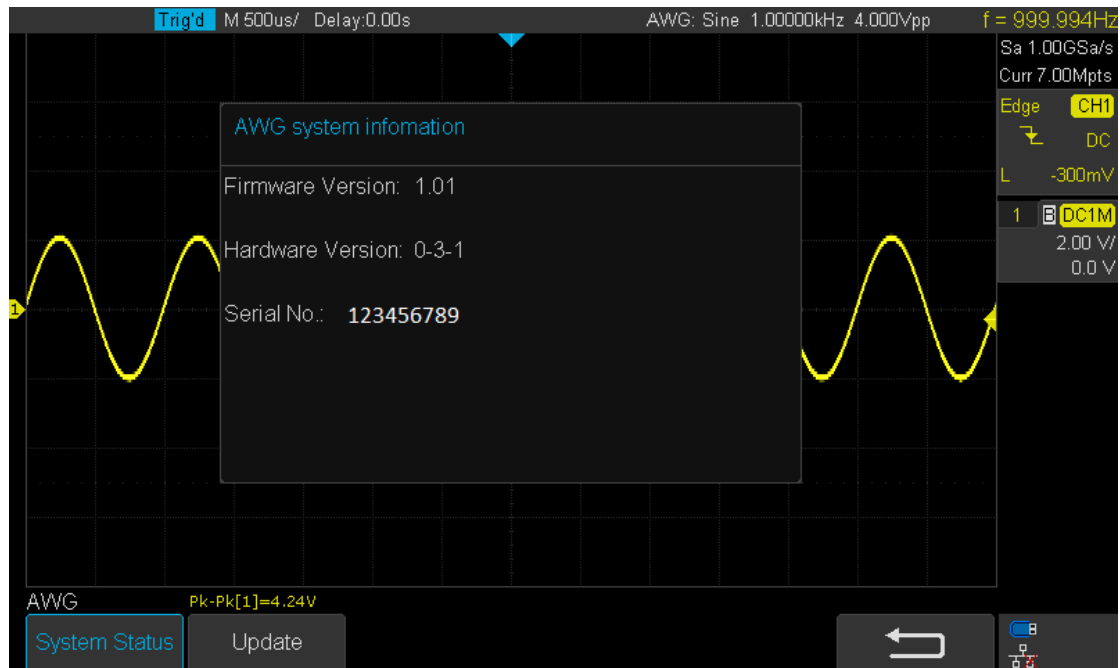

Figure 93 AWG System Information Interface

2. Update

The software version file of the AWG can be updated directly via U-disk. Follow the steps below:

1. Insert U-disk with firmware update file (*.awg) to USB host interface on the front panel of the oscilloscope. A message "USB Flash Drive detected!" Will be displayed.
2. Press **Utility** → **NextPage4/4** → **AWG** → **System** → **Update**
3. Expand the U disk directory, Select the firmware file (*.awg), then press the **Press** to update, an upgrade progress bar will be displayed on the interface.



Figure 94 AWG Update Interface

1. After the update is finished, the AWG will automatically disconnect and display a message "Update completed, please reconnect AWG device!"

Note:

Don't disconnect the power whilst the AWG is being updated !

Remove Device

Press **Utility** → **NextPage4/4** → **AWG** → **RemoveDevice** and the oscilloscope interface will display "AWG device removed!" , the device can be unplugged.

Setting IO Interfaces

The oscilloscope provides abundant IO interfaces, including: USB Device, LAN and Aux Output.

To Set the USB Device

Do the following steps to set the oscilloscope to communicate with a PC via USB:

1. Install the USBTMC device driver on the PC. Also install NI Visa.
2. Connect the oscilloscope with the PC using a standard USB cable.
3. Press the **Utility** button on the front panel to enter the UTILITY function menu.
4. Press the **IO Set** softkey to enter the I/O SET function menu.
5. Press the **USB Device** softkey to select **USBTMC**.
6. Use NI Visa to communicate with the oscilloscope.

Do the following steps to set the oscilloscope to print the screen image:

1. Connect the oscilloscope with printer using a standard USB cable.
2. Press the **Utility** button on the front panel to enter the UTILITY function menu.
3. Press the **IO Set** softkey to enter the I/O SET function menu.
4. Press the **USB Device** softkey to select **Printer**.
5. Press the Print button on the front panel to print the screen image.

To Set the LAN

Do the following steps to set the oscilloscope to communicate with PC via LAN:

1. Connect the oscilloscope to your local area network using the network cable.
2. Press the **Utility** button on the front panel to enter the UTILITY function menu.
3. Press the **IO Set** softkey to enter the I/O SET function menu.
4. Press the **Net Interface** softkey, then select LAN.
5. Press the **IP Set** softkey to enter the IP setting interface, see the picture below:

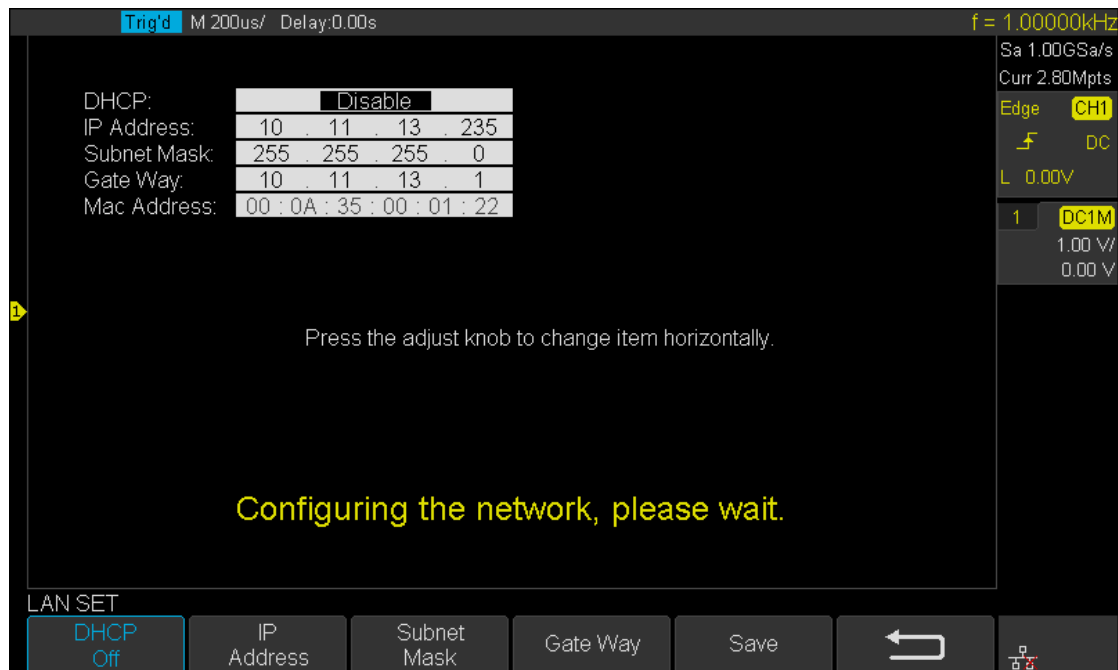

Figure 95 LAN Settings Interface

6. Press the DHCP softkey to turn on or turn off the DHCP.
 - **On:** the DHCP server in the current network will assign the network parameters (such as the IP address) for the oscilloscope.
 - **Off:** you can set the IP address, subnet mask, gateway manually.
 - Turn the **Universal Knob** to select the desired value.
 - Push the **Universal Knob** to move horizontally.
 - Press the **Save** softkey to save the current settings.
7. Use NI Visa to communicate with the oscilloscope.

To Set the WLAN (Option)

The T3DSO1000 series support an external USB WIFI adapter. This option is not available on the T3DSO1102. Do the following steps to set the oscilloscope to communicate with a PC via WLAN:

1. Connect the oscilloscope USB Host to your wireless network adapter, and make sure your local wireless network is enabled.
2. Press the **Utility** button on the front panel to enter the UTILITY function menu.
3. Press the **IO Set** softkey to enter the I/O SET function menu.
4. Press the **Net Interface** softkey, then select WLAN.
5. Press the **WiFi Set** softkey to enter the WiFi set interface.

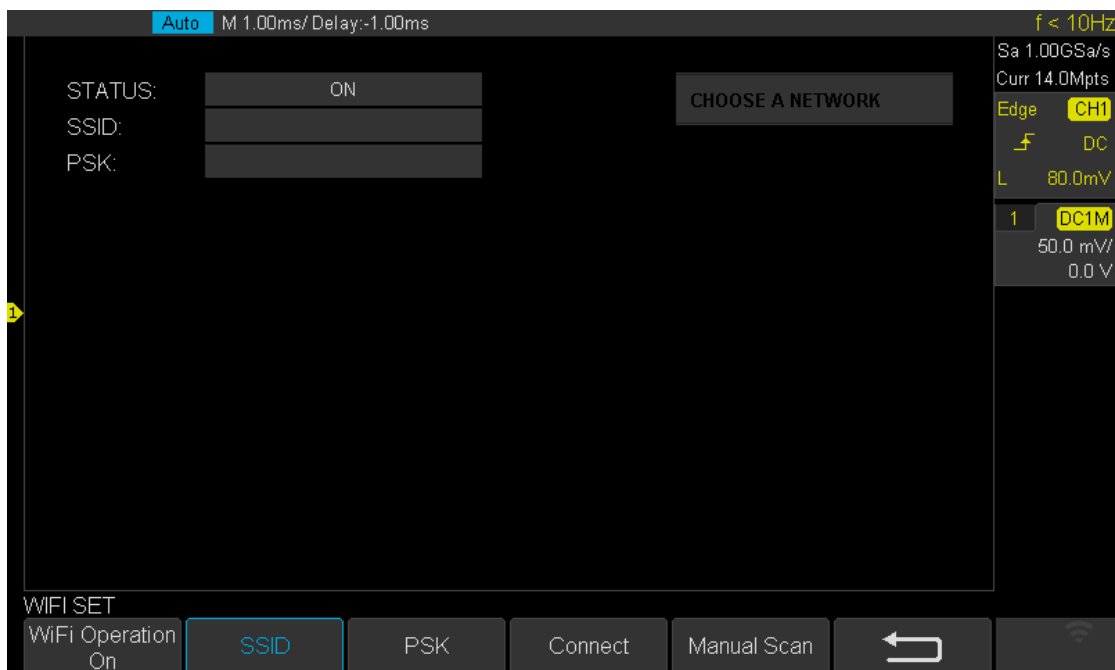

Figure 96 WIFI settings menu

6. Press the WiFi Operation softkey to turn on or turn off the WIFI setup menu.
 - Off:** the WIFI setup menu is off
 - On:** you can set the SSID and PSK manually.
 - Manual Scan: press this softkey, the oscilloscope will search the network automatically. Turn the **Universal Knob** to select a network; then press the **Universal Knob** to confirm.
 - SSID: press this softkey, a dialogue box will pop up, enter your SSID then press **Confirm**.
 - PSK: press this softkey, a dialogue box will pop up, enter your SSID then press **Confirm**.
 - Connect: press this softkey to connect to the wireless network.
7. Press Connect softkey when your SSID and PSK configuration are finished.
8. Return to the I/O SET menu. Press the **IP Set** softkey to finish the IP configuration (see "To Set the LAN")
9. Use NI Visa to communicate with the oscilloscope.

To Set Aux Output

The default Aux output type is **Trig Out**. If **Pass/Fail** is enabled, it will change to **Pass/Fail** automatically.

- **Trig Out:** The oscilloscope outputs a signal on each oscilloscope trigger. The maximal capture rate is 100k wfs/s.
- **Pass/Fail:** The oscilloscope will output a pulse signal when failed waveforms are detected. This signal can be connected to other control systems to conveniently trigger other test equipment or processes.

To Use the Web Server

T3DSO1000 series provides a web server function; you can access and control the oscilloscope using a web browser. Connect the oscilloscope to your LAN (or WLAN), then type the oscilloscope's IP address in the web browser. The oscilloscope's web interface is displayed. The default user name is "admin", and there is no password.

1. Press the **Utility** button on the front panel to enter the UTILITY function menu.
2. Press the **WebServer** softkey on the fourth page of utility function menu to enter the WEBSERVER menu.

Note: This feature is not available on the T3DSO1102.



Figure 97 web server interface

- **Password:** press this softkey to set a new password.
- **Reset:** press this softkey to erase the password.
- **Save:** Select Save to make the new password or erasing the password effective.

To Update Firmware and Configuration

The firmware and configuration can be updated directly via USB flash drive.

Do the following steps to update the firmware:

1. Insert the USB flash drive which contains the firmware and the configure files into the USB host interface on the front panel of the oscilloscope.
2. Press the **Utility** button on the front panel to enter the UTILITY function menu.
3. Press the **Next Page** softkey to go to the second page of the UTILITY function menu.
4. Press the **Next Page** softkey to go to the third page of the UTILITY function menu.
5. Press the **Update** softkey to enter the UPDATE function menu.
6. Press the **Firmware** softkey and the message **“Press “Single” to continue and Press “Run/Stop” to exit!**
7. Press the **Single** button to enter the SAVE/RECALL file system.
8. Turn the **Universal Knob** to select the update file which should be with an ADS postfix, and then press the **Load** softkey to start the firmware update. The process needs about 7 minutes. And during the update, do not turn off the oscilloscope or disconnect the oscilloscope power, otherwise the oscilloscope will not start again.
9. After the update has finished, the screen will display the message **“Update success, please restart the DSO”**, and the oscilloscope buzzer will sound.
10. Restart the oscilloscope to finish the firmware update.

Do the following steps to update the configuration:

1. Insert the USB flash drive which contains the firmware and the configure files into the USB host interface on the front panel of the oscilloscope.
2. Press the **Utility** button on the front panel to enter the UTILITY function menu.
3. Press the **Next Page** softkey to go to the second page of the UTILITY function menu.
4. Press the **Next Page** softkey to go to the third page of the UTILITY function menu.
5. Press the **Update** softkey to enter the UPDATE function menu.
6. Press the **Configure** softkey to enter the SAVE/RECALL file system.
7. Turn the **Universal Knob** to select the update file which will have a CFG postfix, and then press the **Load** softkey to start updating the firmware. The process needs about 30 seconds.
8. After the update has finished, the screen will display the message **“Update success, Please restart the DSO”**, and the oscilloscope buzzer will sound.
9. Restart the oscilloscope to finish the configuration update.

Self Test

Self test includes screen test, keyboard test, buttons, knobs and LED test.

Screen Test

1. Press the **Utility** button on the front panel to enter the UTILITY function menu.
2. Press the **Next Page** softkey to go to the second page of the UTILITY function menu.
3. Press the **Next Page** softkey to go to the third page of the UTILITY function menu.
4. Press the **Do Self Test** softkey to enter the SELFTEST function menu.
5. Press the **Screen Test** softkey to enter the screen test interface. The picture below shows the screen displaying pure red.

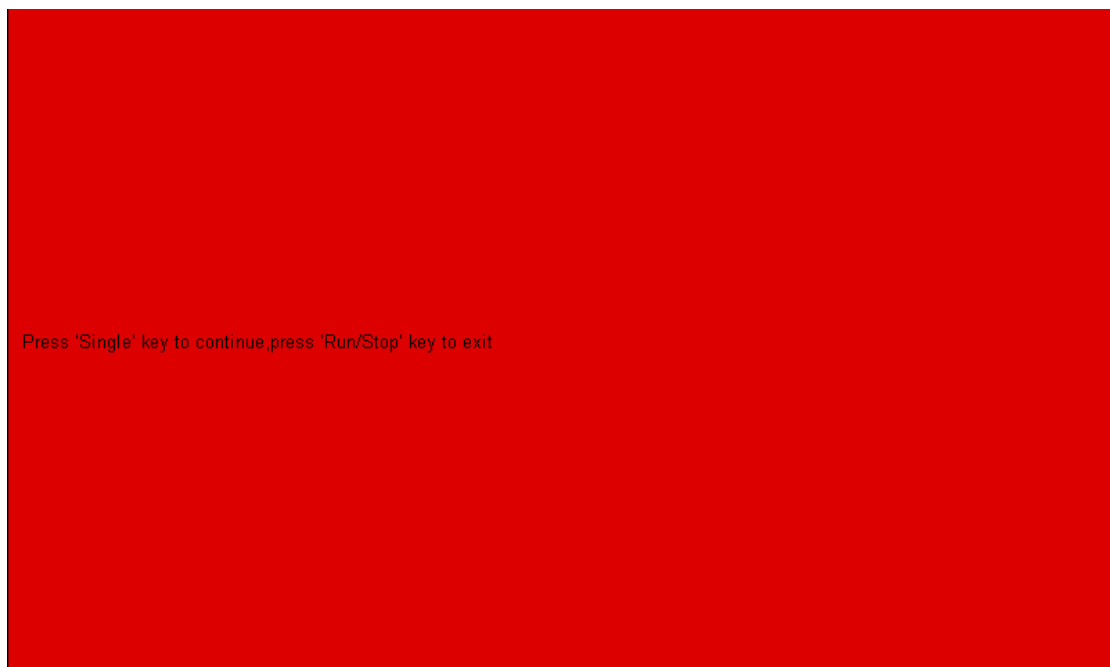

Figure 98 Screen Test

6. Press the **Single** button on the front panel to continue as in the picture above. The screen displays green, blue and red again. It is easy to check chromatic aberrations, stains and scratches of the screen under these conditions.
7. Press the **Run/Stop** button on the front panel to exit the screen test program.

Keyboard Test

Keyboard test is used to test that the keys and knobs work correctly.

Do the following steps to do the keyboard test:

1. Press the **Utility** button on the front panel to enter the UTILITY function menu.
2. Press the **Next Page** softkey to go to the second page of the UTILITY function menu.
3. Press the **Next Page** softkey to go to the third page of the UTILITY function menu.
4. Press the **Do Self Test** softkey to enter the SELFTEST function menu.
5. Press the **Keyboard Test** softkey to enter the keyboard test interface, as the picture shows below.

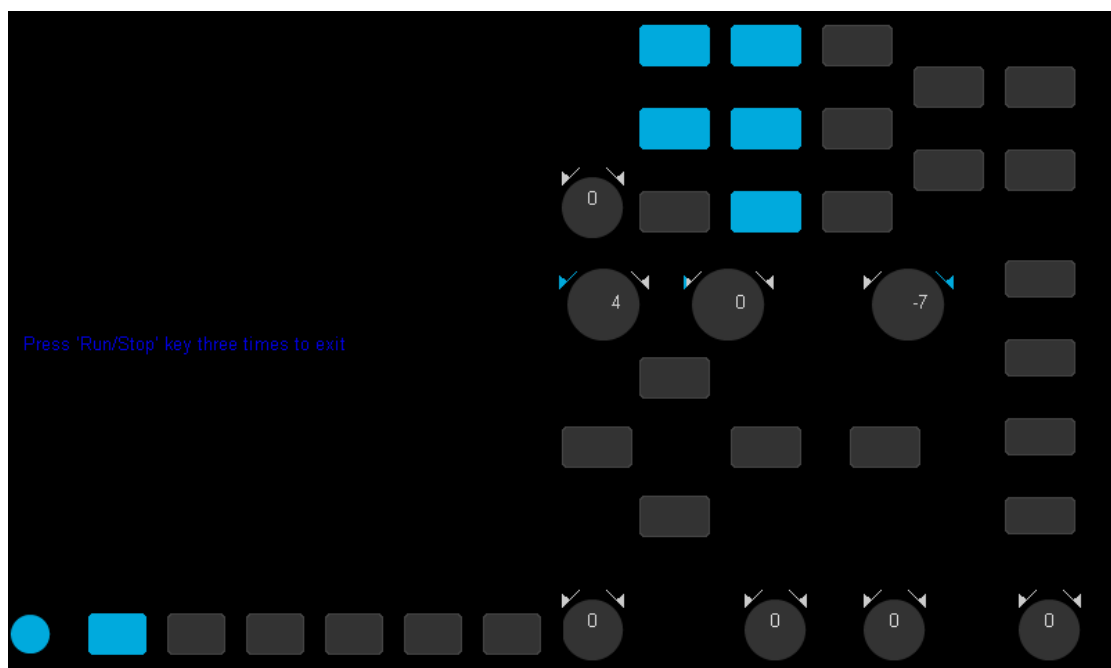

Figure 99 Keyboard Test

6. How to perform the knobs and the buttons test.

Knob test: The default value is 0. Turn the knob left to increase the value whilst turning the knob right will decrease the value. Push the knob to set the value to 0.

Button test: A button will light up the first time a button is pressed, and extinguished the second time the button is pressed.

7. Press the **Run/Stop** button 3 times to exit the keyboard test program.

LED Test

LED test is used to test the button lights.

1. Press the **Utility** button on the front panel to enter the UTILITY function menu.
2. Press the **Next Page** softkey to go to the second page of the UTILITY function menu.
3. Press the **Next Page** softkey to go to the third page of the UTILITY function menu.
4. Press the **Do Self Test** softkey to enter the SELFTEST function menu.
5. Press the **LED Test** softkey to enter the keyboard test interface, as the picture shown below.

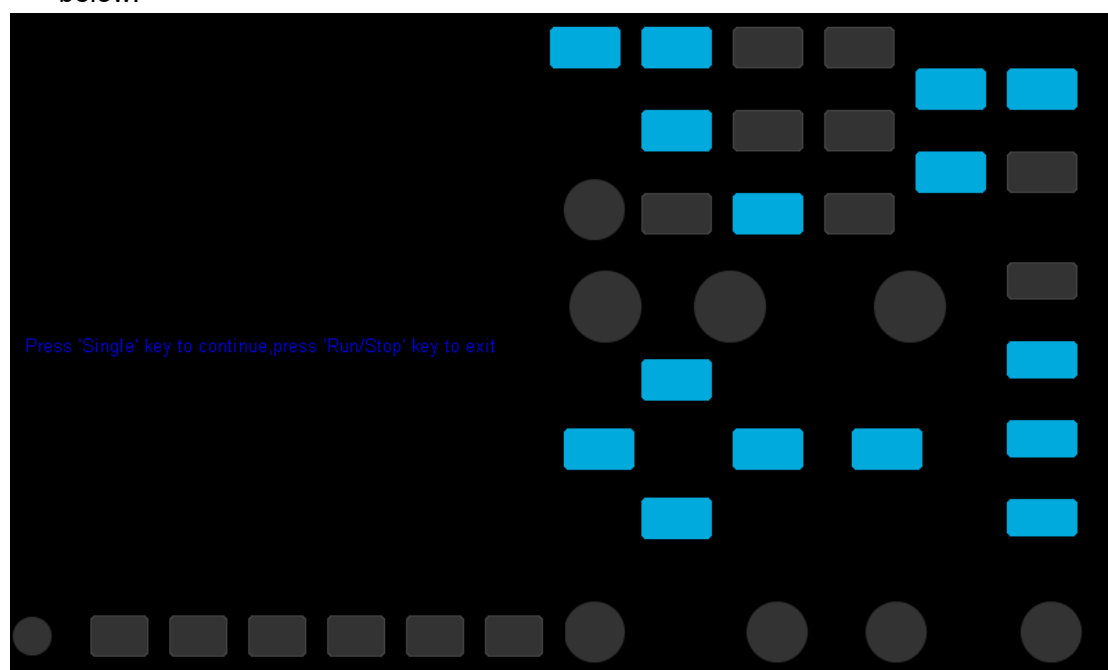

Figure 100 LED Test

6. Use the information displayed on the screen to test the LEDs: press the **Single** button continually to light the button lights one at a time. The **Run/Stop** button displays red the first time the **Single** Button is pressed. On the second press the **Run/Stop** button displays green. Then the other button lights will be lit one by one. On the last press all of the buttons will be lit at the same time.
7. Press the **Run/Stop** button to exit the LED test program.

Specify Screen Saver Time

When the oscilloscope enters the idle state for a certain period of time, the screen saver program will be enabled.

Do the following steps to set the screen saver time:

1. Press the **Utility** button on the front panel to enter the UTILITY function menu.
2. Press the **Next Page** softkey to go to the second page of the UTILITY function menu.
3. Press the **Next Page** softkey to go to the third page of the UTILITY function menu.
4. Press the **Screen Saver** softkey; and then turn the **Universal Knob** to select the desired screen saver time. The screen saver time can be set to **1min**, **5min**, **10min**, **30min**, and **1hour**. Also you can select **Off** to turn off the screen saver function.

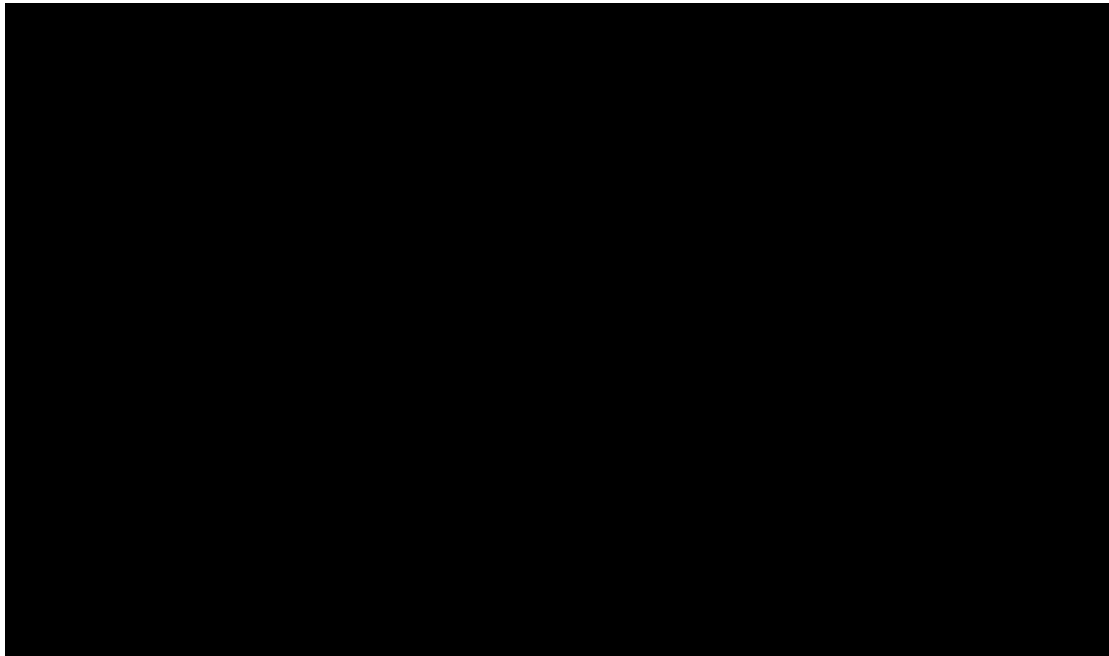

Figure 101 Screen Saver Interface

5. Press the any button on the front to exit the screen saver program.

To Use the Expand Setting

Press the **Utility** button on the front panel; then; press **Expand Setting** softkey to enter the EXPANDESETTING menu.

Press the **Vertical** softkey to select **Fixed Offset** or **Fixed Position**.

Fixed Position: when the vertical gain is changed, the oscilloscope will keep the vertical

offset level indicator stationary.

Fixed offset: when the vertical gain is changed, the oscilloscope will vertical offset level indicator will move with the actual voltage level.

Press the **Horizontal** softkey to select **Fixed Delay** or **Fixed Position**.

Fixed Position: when the timebase is changed, the oscilloscope will keep the horizontal

offset indicator stationary.

Fixed offset: when the timebase is changed, the oscilloscope horizontal offset indicator move with the trigger point.

To Use the Power On Line

Press the **Utility** button on the front panel, then press **Power On Line** softkey to select **Enable** or **Disable**.

Enable: The oscilloscope will turn on automatically when it is plugged in to a live wall socket / power outlet.

Disable: The oscilloscope will NOT turn on automatically when it is plugged in to a live wall socket / power outlet. The power key at the lower-left corner of the front panel of the oscilloscope will need to be pressed to start the oscilloscope.

Option Management

The T3DSO1000 provides multiple options to fulfil your measurement requirements. Please contact your **Teledyne Test Tools** sales representative or **Teledyne Test Tools** technical support to order the corresponding options. You can view the options currently installed on the oscilloscope or activate the newly purchased option license codes through this menu.

Do the following steps to install the option on the oscilloscope:

1. Press the **Utility** button on the front panel to enter the UTILITY function menu.
2. Press the **Next Page** softkey to go to the third page of the UTILITY function menu.
3. Press the **Options** softkey to enter the OPTION function menu.

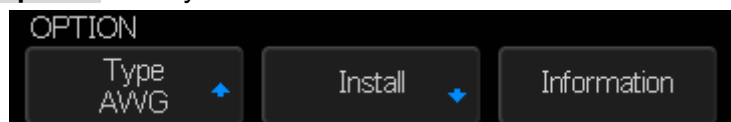

Figure 102 OPTION Function Menu

4. Press the **Type** softkey; then turn the **Universal Knob** to select the module to be installed and push down the knob to confirm.
5. Press the **Install** softkey to enter the LABEL function menu to input the license.

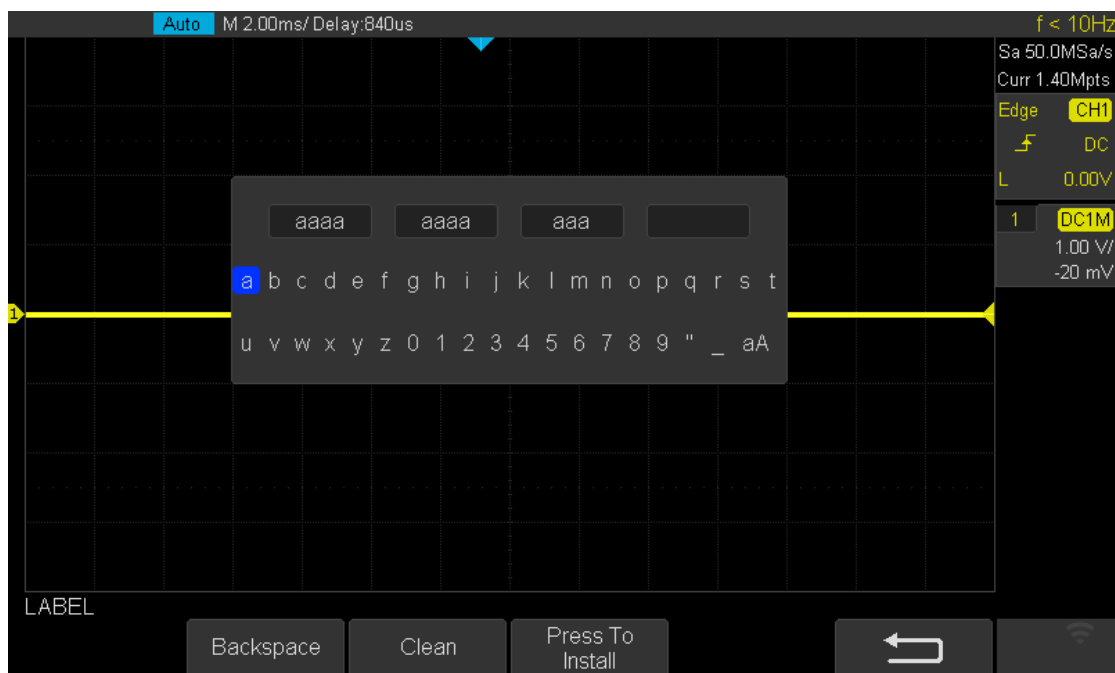

Figure 103 LABEL Function Menu

- Turn the **Universal Knob** to select character
 - Push the **Universal Knob** to confirm the characters
 - Press the **Press To Install** when license key input is complete.
 - Press the **Clean** softkey or the **Backspace** softkey to delete an incorrect character.
6. Press the **Information** softkey to view the option information.

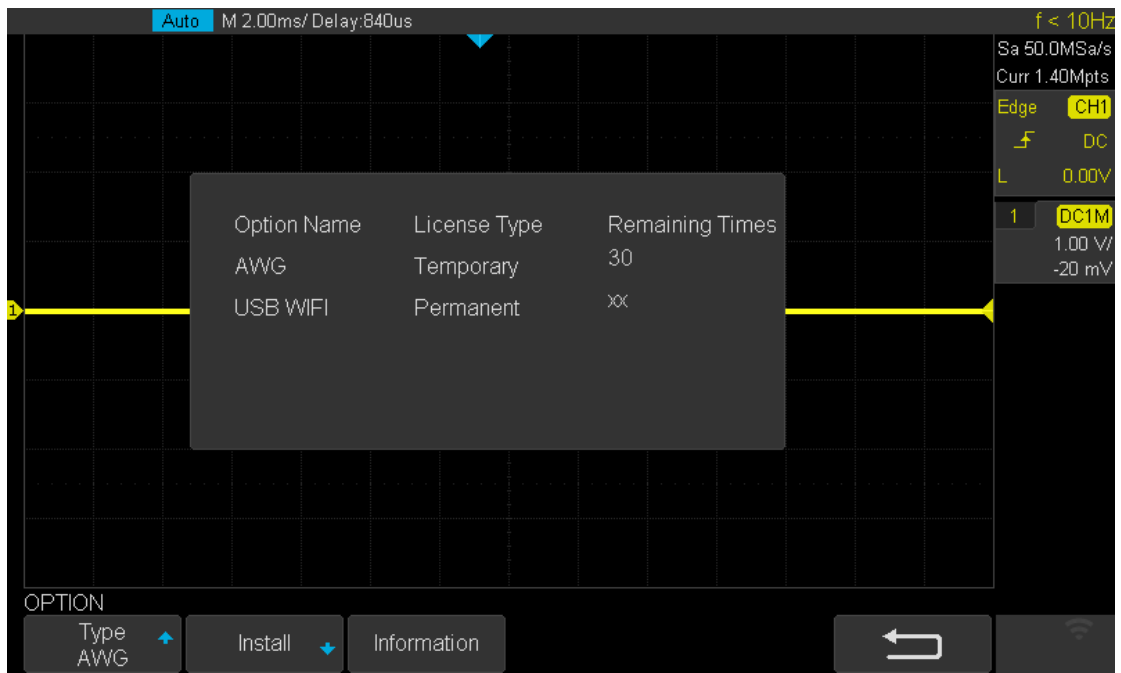

Figure 100 Option Information

Search

The T3DSO1000 series provide a search function. This function can search for the events that users specify in the acquired data. The results are displayed with a white triangle symbol. The maximum search events is 700 in the YT mode or the Roll mode with the acquisition in stopped. In the Roll mode, with acquisition in running, the maximum search events number is unlimited. The waveform can be zoomed when the search function is enabled.

The T3DSO1102 oscilloscope does not have the search function.

Setting

1. Press the **Search** button on the front panel to enter the SEARCH function menu
2. Press the **Mode** softkey and then use the **Universal Knob** to select the desired search type. The T3DSO1000 series provide five search types: Edge, Slope, Pulse, Interval, Runt.



Figure 105 Search menu

3. Press the Setting softkey to enter the SETTING function menu. The setting menu is different according to every search type. The details are shown in the following table.

Search Mode	Setting Menu Description
Edge	Slope includes Rising, Falling, Either.
Slope	Slope includes Rising, Falling Limit Range includes four types: <=, >=, [--,--] and --][-- , Users can select the desired type and then input the time value.
Pulse	Polarity includes Positive and Negative Limit Range includes four types: <=, >=, [--,--] and --][-- , Users can select the desired type and then input the time value.
Interval	Slope includes Rising, Falling Limit Range includes four types: <=, >=, [--,--] and --][-- , Users can select the desired type and then input the time value.
Runt	Polarity includes Positive and Negative Limit Range includes four types: <=, >=, [--,--] and --][-- , Users can select the desired type and then input the time value

4. Press Copy softkey to enter the COPY function menu.
 - Copy from Trig: copy the trigger setup for the selected search type to the search setup.
 - Copy to Trig: copy the setup for the selected search type to set the trigger type.
 - Cancel Copy: undo a copy.
5. Press Thresholds softkey to enter THRESHOLDS function menu, then set the channel search thresholds.

Results

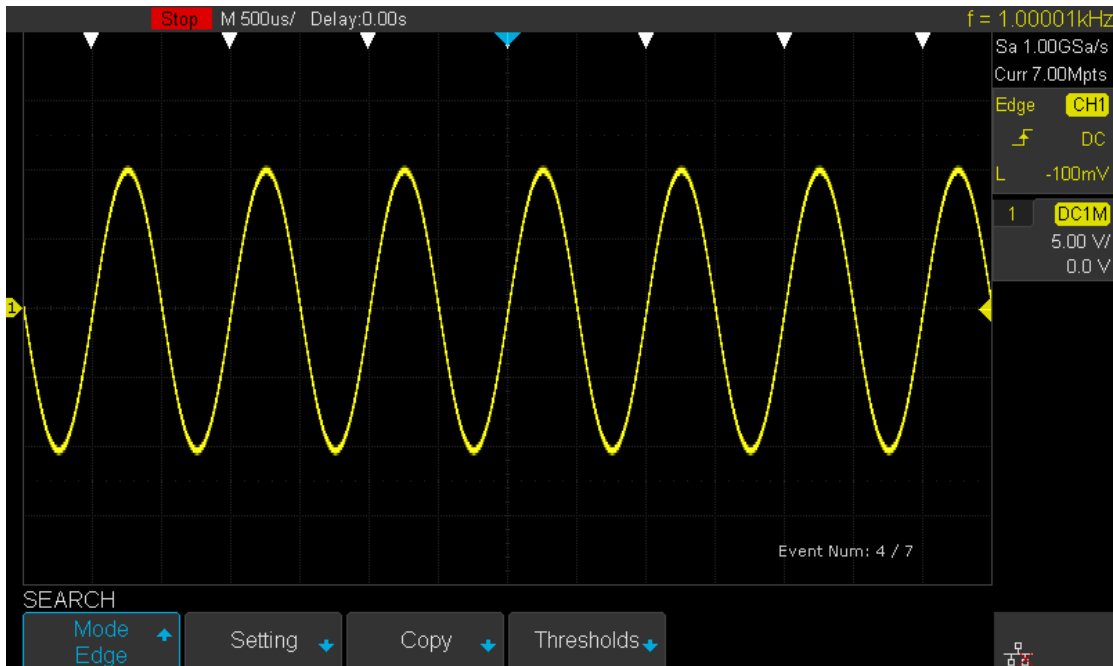

Figure 106 Search When Stopped

For example, when the acquisition is stopped, “EVENT NUM:4/7” means the current event number and total number of events. The current event (number 4) is the closest event to the middle of the screen.

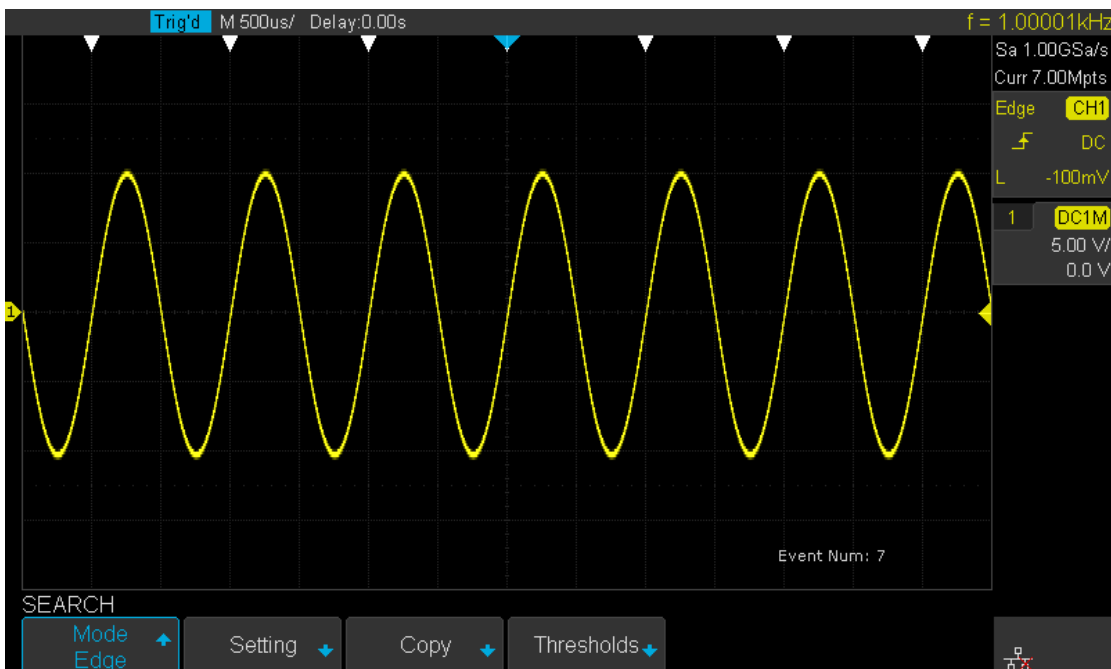

Figure 107 Search When Running.

When the acquisition is running, “EVENT NUM:7” means the total number of events.

Navigate

The T3DSO1000 series provide three navigation types: Search Event, Time, History Frame.

Note: This feature is not available on the T3DSO1102 model.

Time navigate

1. Press **Navigate** on the front panel to enter the NAVIGATE function menu.
2. Press **Type** softkey In the NAVIGATE function menu, then, select **Time**.
3. There are two ways to navigate time.
 - a) Press **Time** softkey, then turn the Universal Knob to select the desired value or press the Universal Knob then enter the value in the pop up keyboard.
 - b) Press the navigation keys **◀■▶** on the front panel to play backward, stop, or play forward in time. You can press the **◀** or **▶** keys multiple times to speed up the playback. There are three speed levels: Low Speed, Medium Speed, High Speed.

History frame navigate

When the History function is enabled, you can use the navigation controls to play through the acquired frames.

1. Press **Navigate** on the front panel to enter the NAVIGATE function menu.
2. Press **Type** In the Navigate Menu, then select **History Frame**.
3. Press **Frame Num** softkey. There are two ways to navigate history frames.
 - a) Turn the Universal Knob to select the desired number or press the Universal Knob then enter the number using the pop up keyboard.
 - b) Press the navigation keys **◀■▶** on the front panel to play backward, stop, or play forward.

Search event navigate

When the Search function is enabled and acquisitions are stopped, you can use the navigation controls to go to the search events.

1. Press **Navigate** on the front panel to enter the NAVIGATE function menu.
2. Press **Type** In the NAVIGATE function menu; then, select **Search Event**.
3. There are two ways to navigate search events.
 - a) Press **Event Num** softkey, then, turn the Universal Knob to select the desired value or press the Universal Knob then enter the value from the pop up keyboard.
 - b) Press the navigation keys ◀ ▶ on the front panel to go to the previous or next search event.

Bode Plot

The bode plot application for the T3DSO1000 series oscilloscopes controls an external arbitrary waveform generator to sweep a sine wave across a range of frequencies while measuring the input to and output from a device under test (DUT). At each frequency, gain and phase are measured and plotted on a Bode chart.

The supported waveform generators of the T3DSO1000 series are the optional T3DSO1000-FGMOD or T3DSO1000-FGMOD-A waveform generators, or the T3AFG40, T3AFG80 or T3AFG120 arbitrary function generators.

The T3DSO1000-FGMOD or T3DSO1000-FGMOD-A waveform generators are options to the T3DSO1000 oscilloscope range.

The T3DSO1000-FGMOD-A is an isolated waveform generator which can be directly connected into a low voltage circuit without the need for an injection transformer due to being isolated. The waveform generator's isolation specification supports a maximum externally applied voltage of 42 Vpk. Any voltage beyond 42 Vpk will damage the T3DSO1000-FGMOD-A. Use an injection transformer if a voltage exceeding 42 Vpk is expected.

The T3DSO1000-FGMOD, T3AFG40, T3AFG80 and T3AFG120 are not isolated and should only be used with an injection transformer when injecting into active feedback circuit applications.

The T3AFG40, T3AFG80 or T3AFG120 can be controlled directly by the T3DSO1000 via an ethernet connection between the T3DSO1000 and the T3AFG40, T3AFG80 or T3AFG120.

Bode Plot, control of the T3DSO1000-FGMOD(-A), T3AFG40, T3AFG80 or T3DSO120 is not supported on the T3DSO1102 oscilloscope.

Perform Bode Plot Application

This section gives an overview of the steps to take when performing a Bode Plot measurement.

1. Press the **Utility** on the front panel to enter the UTILITY function menu; then press the **Next Page** softkey to enter the second page.
2. Press **Bode Plot** softkey to enter the BODEPLOT function menu, only the **Default** button on the front panel can be used.

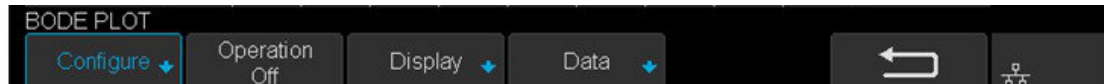

Figure 108 Bode plot menu

3. Configure the parameters (the details see the “**setting**” section).
4. Press **Operate** softkey to perform the test.

Setting

1. Press **Configure** softkey to enter the Configure menu. All the parameters in this menu are used to configure the external AWG.

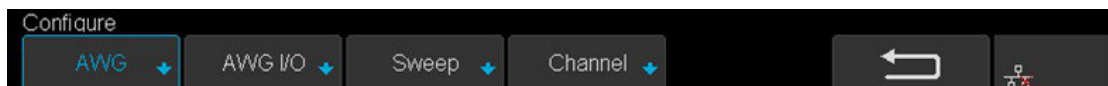

Figure 109 Bode plot configure menu

- (1) Press **AWG** softkey to enter AWG menu.
 - Press the **Amplitude** softkey (**Offset** softkey), then turn the Universal Knob to select the desired value, or press the Universal Knob then enter the value using the pop up keyboard.
 - Press the **Unit** softkey, then turn the Universal Knob to select the desired units. There are six types: Vpp, Vrms, dBV, dBu, dBm, Arbitrary dB. The dBu is only available when the load impedance is specified as 600 ohms.
 - Press the **Load** softkey, then turn the Universal Knob to select the desired value, or press the Universal Knob then enter the value using the pop up keyboard.

- (2) Press **AWG I/O** softkey to enter the AWG I/O menu.
- Press the **Type** softkey, then turn the Universal Knob to select the desired type.

USB	Connect the oscilloscope USB Host to the external AWG's USB Device via a USB cable.
LAN	Connect the oscilloscope and the external AWG to your local area network.

- If the LAN is selected, press the **IP** softkey. A dialog box named "IP" will pop up. Turn the universal knob to enter the IP value. The IP is the external AWG's IP.
 - Press **Test Connection** softkey to check the connection.
- (3) Press the **Sweep** softkey to enter the Sweep menu.
- Linear mode, this mode gives center frequency and span frequency adjustments.
 - Logarithmic mode, this mode gives start frequency and stop frequency adjustments.
 - Press **Resolution** softkey, then turn the universal knob to select the type. There are three resolution levels: Low, Medium, and High.
- (4) Press **Channel** softkey to enter the Channel menu. Press **DUT Input** softkey to choose the oscilloscope's channel which connects to the DUT input (the AWG's output). Press **DUT Output1** softkey to choose the oscilloscope's channel which connects to the DUT output (up to 3 channels).
2. Press **Display** softkey to enter the Display menu. All the parameters in this menu are used to configure the bode chart.



Figure 110 Bode plot display menu

- (1) Press **Amplitude** softkey to enter the Amplitude menu.
- Press **Scale** softkey, then turn the Universal Knob to select the desired value.
 - Press **Ref Level** softkey, then turn the Universal Knob to select the desired value or press the Universal Knob then enter the value using the pop up keyboard.
 - Press **Auto Set** softkey to automatically set the appropriate parameters for the frequency response gain curve.
 - Press **Mode** softkey to set the mode of the frequency response gain curve. Vout/Vin means that the measured gain value of each frequency point is the ratio of DUT input signal amplitude to DUT output signal amplitude. Vout means that the measured gain values of each frequency point is the DUT output signal amplitude.

When Vout/Vin mode is enabled, the Y-Axis can be set to linear or logarithmic by pressing **Axis Type** softkey. When Vout mode is enabled, there are six types unit can be chosen by pressing **Unit** softkey.

- (2) Press **Phase** softkey to enter the Phase menu.
 - Press **Scale** softkey, then turn the Universal Knob to select the desired value.
 - Press **Ref Level** softkey, then turn the Universal Knob to select the desired value or press the Universal Knob then enter the value by the pop keyboard.
 - Press **Unit** softkey to set the unit to deg or rad.
 - Press **Auto Set** softkey to set the appropriate parameters for the frequency response phase curve automatically.
 - (3) Press **Cursors** softkey enter the Cursors menu. Press **Status** softkey in this menu can enable or disable the cursors function. The details of cursors see Chapter “Cursors”.
3. Press **Data** softkey to enter the Data menu. All the parameters in this menu are used to configure the bode chart.



Figure 111 Bode plot data menu

- (1) Press **List** softkey to select “On” or “Off” to turn on or turn off the list table. When the list is on, press Scroll softkey, then turn the Universal Knob to select the frequency point or press the Universal Knob then enter the number of the frequency point by the pop keyboard.

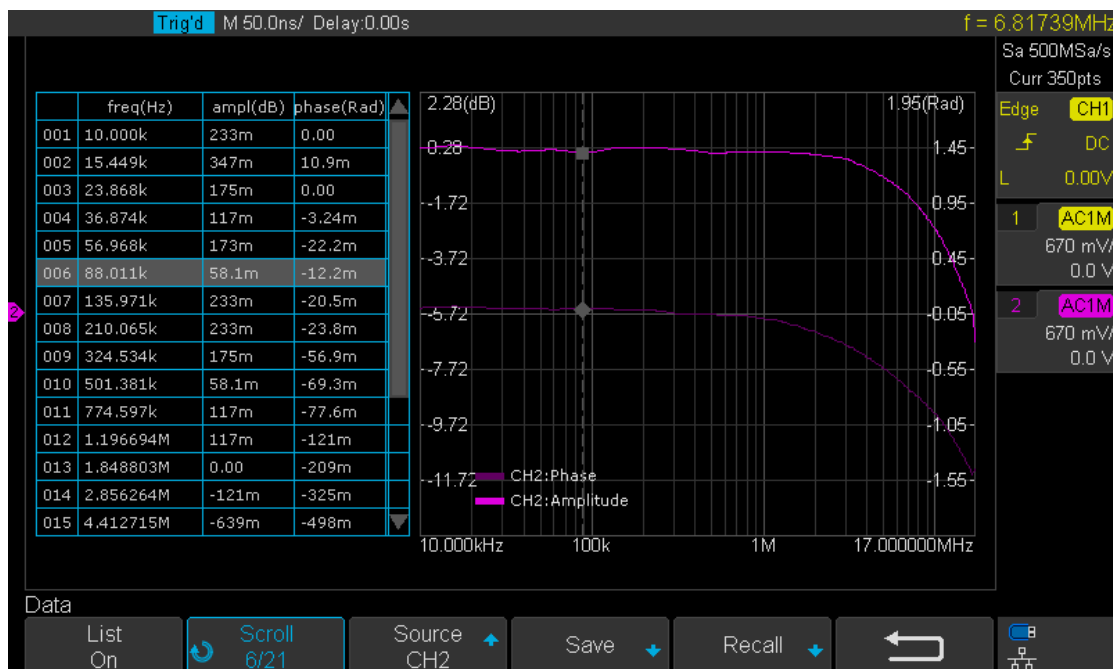

Figure 112 Bode plot list on

- (2) Press **Source** softkey to choose the output DUT channel that you require.
- (3) Press **Save** softkey (**Recall** softkey) to enable the bode plot save (recall) function. For the details of save (recall) see Chapter “Save and Recall”.

The History Function

The history function will continuously record the waveforms of the input channels. The oscilloscope records input waveform continually when running. When the history memory is full (reach the maximal frame) the new acquisitions will replace the old acquisitions and keep the latest acquisitions (FIFO).

To use the History function, the HORIZONTAL **Format** must be set to **YT**.

Do the following steps to record and replay a waveform:

1. Press the **History** button on the front panel to enable the History function.
 - If the oscilloscope is running, it will then stop.
 - If the oscilloscope is stopped it will remain in the stopped state.
 - Press the **History** or **Stop** button to turn off the History function.
2. Press the **List** softkey to turn on or off the list display. The list records the timestamp of every frame. It is accurate to microseconds.

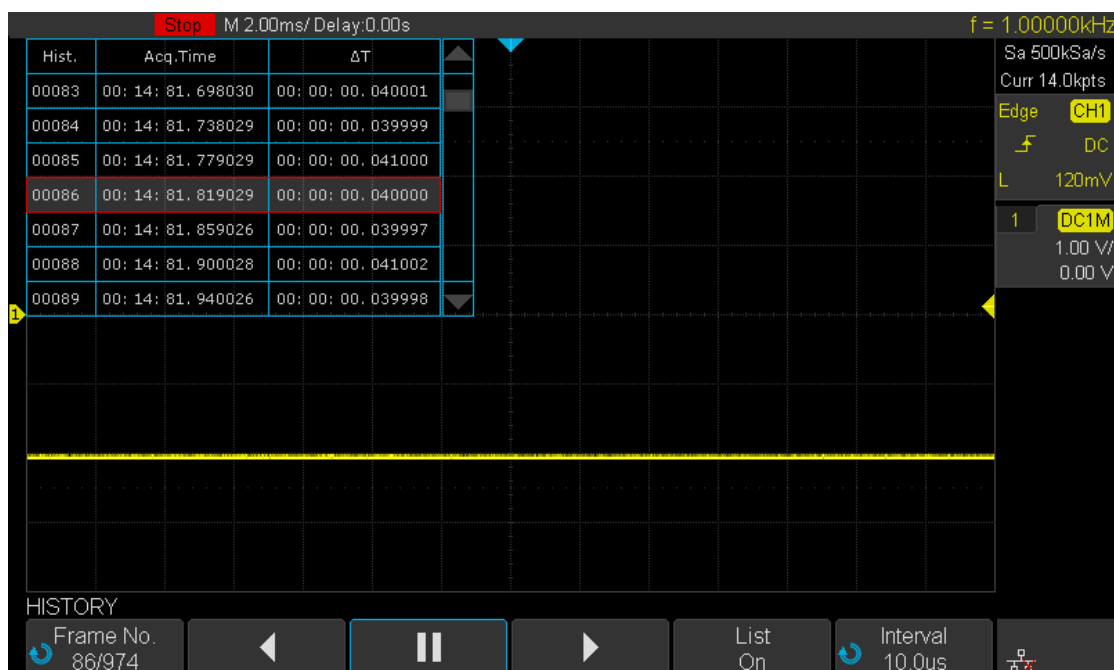





Figure 113 History

3. Press the **Frame** softkey; then turn the **Universal Knob** to select the acquisition to display.
 - The format of the **Frame** is A/B; A is the acquisition number that is displaying on the screen and B is the maximal acquisition number that can be set.

- The maximal acquisition number is determined by the current sampling point (**Curr** value) and sampling rate.
- The History Mode maximum acquisition count can only be reached if enough acquisitions have been acquired, otherwise a smaller number of acquisitions will be shown.

The table below shows the maximal number of acquisition frames according to the sampling rate and current number of sampling points.

Sample Rate	Curr (pts)	Max. Frame	Sample Rate	Curr (pts)	Max. Frame
1GSa/s	≅ 280	80000	500MSa/s	35K	783
	700	57227		70K	391
	1.4K	33528		140K	195
	2.8K	18338		350K	77
	7K	7773		700K	38
	14K	3982		1.4M	18
	28K	1993		3.5M	6
	70K	798		7M	3
	140K	398		14M	1
	280K	198		3.5K	3779
	700K	78		7K	1891
	1.4M	38		14K	945
	2.8M	18		17.5K	757
	7M	7		35K	378
14M	3	70K	188		
500MSa/s	≅ 35	80000	≅ 250MSa/s	140K	93
	70	77026		175K	74
	140	65667		700K	17
	350	45526		1.4M	8
	700	29140		1.8M	6
	1.4K	16945		3.5M	3
	3.5K	7510		7M	1
	7K	3912		14M	1
	14K	1958			



4. Press the  softkey to replay the waveform from the current frame to 1.
5. Press the  softkey to stop replay.
6. Press the  softkey to replay the waveform from the current frame to the last frame.

Factory Setup

Press Save/Recall function key, then press “Save” menu. Select “To Default Key”, set the type to “Factory Setup”. Then press the Default button on the front to set the oscilloscope to the factory setup. Another way is to press Save/Recall function key, then press “Recall” menu. Select “Factory Default” to recall.

The Factory Default details are shown below.

Horizontal	
T/div	1 μ S/div
Delay	0 S
Zoom	Off
Format	Y-T
Vertical	
Channel on/off	CH1
V/div	1 V/div
Offset	0 V
Coupling	DC
BW Limit	Full
Adjust	Coarse
Probe	1X
Impedance	1 M Ω
Unit	V
Invert	Off
Acquire	
Acquisition	Normal
Sinx/x	Sinx
Mem Depth	14 Mpts
Trigger	
Type	Edge
Source	CH1
Slope	Rising
Holdoff	Off
Coupling	DC
Noise Rejest	Off

Mode	Auto
Display	
Type	Vectors
Color	Off
Persist	Off
Grid	
Intensity	50%
Graticule	20%
Transparence	80%
Cursor	
Mode	Off
Type	X1
Source	CH1
X1	-3.5µs
X2	3.5µs
Save/Recall	
Type	Setups
Save To	Internal
Setup	NO.1
Utility	
IO Set	
USB Device	USBTMC
Aux Output	Trig Out
Sound	
Sound	On
Pass/Fail	
Enable Test	Off
Source	CH1
Operate	Off
Mes Display	Off
X Mask	0.2
Y Mask	0.2
Location	Internal
Fail To Stop	Off
Output	
System Setup	

Quick-Cal	Off
Screen Saver	30min
Math	
Operate	Off
+	
Source A	CH1
Source B	CH1
Invert	Off
V/div	1.00 V/div
offset	0V
-	
Source A	CH1
Source B	CH1
Invert	Off
V/div	1.00 V/div
offset	0 V
*	
Source A	CH1
Source B	CH1
Invert	Off
V/div	1.00 V ² /div
offset	0 V ²
/	
Source A	CH1
Source B	CH1
Invert	Off
V/div	1.0/div
offset	0
FFT	
Source	CH1
Window	Hanning
Horizontal	1X
Vertical Scale	20 dBVrms
Display	Split
Horizontal Scale	100MHz
d/dt	
Source	CH1
Vertical Scale	1.00 (MV/S)/div

Vertical Offset	0
dx	0.2 div
∫dt	
Source	CH1
Offset	0
Vertical Scale	1.00 μ V/div
Vertical Offset	0
√	
Source	CH1
Vertical Scale	1.00 $V^{1/2}$ /div
Vertical Offset	0
REF	
Source	CH1
Location	REF A
Display	Off

Troubleshooting

The commonly encountered failures and their solutions are listed below. Please contact **Teledyne Test Tools** if the problem is not listed below and you need further assistance.

1. **The screen has no display after power on:**
 - 1) Check whether the power is correctly connected.
 - 2) Check whether the power switch is on.
 - 3) Check whether the fuse has blown. If the fuse needs to be changed, please use the specified fuse.
 - 4) Restart the instrument after finishing the above checks.
 - 5) If it still does not work correctly, please contact **Teledyne Test Tools**.

2. **The signal is sampled but no waveform is displayed:**
 - 1) Check whether the probe is correctly connected to the DUT waveform.
 - 2) Check whether the probe or BNC cable is correctly connected to the oscilloscope BNC.
 - 3) Check whether the oscilloscope channel is turned on.
 - 4) Check whether there are signals generated from the item to be tested (you can connect the probe compensation signal to the oscilloscope channel to ensure that the scope channel and probe are working correctly).
 - 5) Resample the signal, press Run.

3. **The tested voltage amplitude is greater or lower than the actual value (note that this problem usually occurs when a probe is used):**

Check whether the attenuation coefficient of the channel complies with the attenuation ratio of the probe.

4. **There is an unstable waveform display:**
 - 1) Check that the trigger signal source has a suitable signal to trigger on.
 - 2) Check the trigger type: general signals should use the "Edge" trigger.
 - 3) Change the trigger holdoff setting if the signal is a burst type waveform.

5. **No display after pressing Run/Stop:**

Check whether the trigger mode (TRIGGER) is on "Normal" or "Single" and whether the trigger level exceeds the waveform voltage range. Try setting the trigger level to the middle of the expected waveform voltage range, or set the mode to "Auto".

Note: using **AUTO** will automatically trigger the scope whether there is a waveform present or not.

6. **The display of waveform is ladder-like:**

- 1) The horizontal time base might be too low. Increase the horizontal time base to increase the horizontal resolution and improve the display.
- 2) If the display **Type** is "Vectors", the lines between the sample points may cause ladder-like display. Set **Type** to "Dots" to solve the problem.

7. **Failure to connect to the PC through USB:**

Check the **IO Setting** in **Utility** to make sure that the setting in **USB Device** matches the device currently connected. If changes are made then restart the oscilloscope for the new settings to take effect (cycle the power).

8. **The USB storage device isn't recognized:**

- 1) Check whether the USB storage device is working normally and formatted as FAT32.
- 2) Make sure that the USB interface is work normally. Test is with another USB storage device.
- 3) Make sure that the USB storage device being used is flash storage. This oscilloscope does not support other hardware storage types.
- 4) Restart the instrument and then insert the USB storage device to check it.
- 5) If the USB storage device still cannot be used normally, please contact **Teledyne Test Tools**.

Certifications

Teledyne LeCroy certifies compliance to the following standards as of the time of publication. Please see the EC Declaration of Conformity document shipped with your product for current certifications.

EMC Compliance

EC DECLARATION OF CONFORMITY - EMC

The instrument meets intent of EC Directive 2014/30/EU for Electromagnetic Compatibility. Compliance was demonstrated to the following specifications listed in the Official Journal of the European Communities:

EN 61326-1:2013, EN 61326-2-1:2013 EMC requirements for electrical equipment for measurement, control, and laboratory use.¹

Electromagnetic Emissions:

EN 55011:2016+A1:2017, Radiated and Conducted Emissions Group 1, Class A^{2, 3}

EN 61000-3-2:2014 Harmonic Current Emissions, Class A

EN 61000-3-3:2013 Voltage Fluctuations and Flickers, Pst = 1

Electromagnetic Immunity:

EN 61000-4-2:2009 Electrostatic Discharge, 4 kV contact, 8 kV air, 4 kV vertical/horizontal coupling planes⁴

EN 61000-4-3:2006+ A2:2010 RF Radiated Electromagnetic Field, 3 V/m, 80-1000 MHz; 3 V/m, 1400 MHz - 2 GHz; 1 V/m, 2 GHz - 2.7 GHz

EN 61000-4-4:2012 Electrical Fast Transient/Burst, 1 kV on power supply lines, 0.5 kV on I/O signal data and control lines⁴

EN 61000-4-5:2014+A1:2017 Power Line Surge, 1 kV AC Mains, L-N, L-PE, N-PE⁴

EN 61000-4-6:2014 RF Conducted Electromagnetic Field, 3 Vrms, 0.15 MHz - 80 MHz

EN 61000-4-11:2004+A1:2017 Mains Dips and Interruptions, 0%/1 cycle, 70%/25 cycles, 0%/250 cycles^{4, 5}

¹ To ensure compliance with all applicable EMC standards, use high-quality shielded interface cables.

² Emissions which exceed the levels required by this standard may occur when the instrument is connected to a test object.

³ This product is intended for use in nonresidential areas only. Use in residential areas may cause electromagnetic interference.

⁴ Meets Performance Criteria "B" limits of the respective standard: during the disturbance, product undergoes a temporary degradation or loss of function or performance which is self-recoverable.

⁵ Performance Criteria "C" applied for 70%/25 cycle voltage dips and for 0%/250 cycle voltage interruption test levels per EN61000-4-11.

European Contact:*

Teledyne GmbH, European Division

Im Breitspiel 11c

D-69126 Heidelberg

Germany

Tel: + 49 6221 82700

AUSTRALIA & NEW ZEALAND DECLARATION OF CONFORMITY – EMC

The instrument complies with the EMC provision of the Radio Communications Act per the following standards, in accordance with requirements imposed by Australian Communication and Media Authority (ACMA):

AS/NZS CISPR 11:2015 Radiated and Conducted Emissions, Group 1, Class A.

Australia / New Zealand Contacts:*

RS Components Pty Ltd.	RS Components Ltd.
Suite 326 The Parade West	Units 30 & 31 Warehouse World
Kent Town, South Australia 5067	761 Great South Road
	Penrose, Auckland, New Zealand

* Visit teledynelecroy.com/support/contact for the latest contact information.

Safety Compliance

EC DECLARATION OF CONFORMITY – LOW VOLTAGE

The instrument meets intent of EC Directive 2014/35/EU for Product Safety. Compliance was demonstrated to the following specifications as listed in the Official Journal of the European Communities:

EN 61010-1:2010 Safety requirements for electrical equipment for measurement, control, and laboratory use –

Part 1: General requirements

EN 61010-2:030:2010 Safety requirements for electrical equipment for measurement, control, and laboratory use –

Part 2-030: Particular requirements for testing and measuring circuits

The design of the instrument has been verified to conform to the following limits put forth by these standards:

- Mains Supply Connector: Overvoltage Category II, instrument intended to be supplied from the building wiring at utilization points (socket outlets and similar).
- Measuring Circuit Terminals: No rated measurement category. Terminals not intended to be connected directly to the mains supply.
- Unit: Pollution Degree 2, operating environment where normally only dry, non-conductive pollution occurs. Temporary conductivity caused by condensation should be expected.

THIRD PARTY AGENCY CERTIFICATION

The instrument has been certified by TUV SUD product Services GmbH for all the applicable European Union (EU) safety requirements per IEC 61010-1 and IEC 61010-2-030 standards.

U.S. NATIONALLY RECOGNIZED AGENCY CERTIFICATION

As an accredited National Recognized Testing Laboratory (NRTL), TUV SUD Product Services GmbH has certified the instrument to meet all the applicable US safety standards. The instrument is marked with the TUV SUD NRTL mark for U.S.

CANADIAN CERTIFICATION

The instrument has been certified by TUV SUD Product Services GmbH to meet all the applicable Canadian safety standards and bears the TUV SUD NRTL mark for Canada.

Environmental Compliance

END-OF-LIFE HANDLING



The instrument is marked with this symbol to indicate that it complies with the applicable European Union requirements of Directives 2012/19/EU and 2006/66/EC on Waste Electrical and Electronic Equipment (WEEE) and Batteries.

The instrument is subject to disposal and recycling regulations that vary by country and region. Many countries prohibit the disposal of waste electronic equipment in standard waste receptacles. For more information about proper disposal and recycling of your Teledyne LeCroy product, please visit teledynelecroy.com/recycle.

RESTRICTION OF HAZARDOUS SUBSTANCES (RoHS)

EC DECLARATION OF CONFORMITY – RoHS

Unless otherwise specified, all the materials and processes are compliant with RoHS Directive 2011/65/EU in its entirety, inclusive of any further amendments or modifications of said Directive.

CHINA RoHS 2

Unless otherwise specified, all the materials and processes are compliant with the latest requirements of China RoHS 2. The hazardous substances contained in the instrument are disclosed in accordance with the standards SJ/T 11364-2014 (Marking for the restricted use of hazardous substances in electronic and electrical products) and GB/T 26572-2011 (Requirements on concentration limits for certain restricted substances in electrical and electronic products). The instrument is marked with an appropriate Environmental Friendly Use Period (EFUP) symbol. The packaging materials include the appropriate recycling labels. The below substance disclosure tables (in Chinese and English languages) provide the required compliance information.

部件名称	有毒有害物质和元素					
	铅 (Pb)	汞 (Hg)	镉 (Cd)	六价铬 (Cr6+)	多溴联苯 (PBB)	多溴二苯醚 (PBDE)
PCBAs	X	O	O	O	O	O
机械硬件	O	O	O	O	O	O
金属片	O	O	O	O	O	O
塑料部件	O	O	O	O	O	O
电缆组件	X	O	O	O	O	O
显示器	O	O	O	O	O	O
电源	O	O	O	O	O	O
风扇	O	O	O	O	O	O
电池	O	O	O	O	O	O
电源线	O	O	O	O	O	O
外部电源(如有)	X	O	O	O	O	O
探头(如有)	X	O	O	O	O	O
熔丝(如有)	O	O	O	O	O	O
产品外壳(如有)	O	O	O	O	O	O
适配器/模块(如有)	O	O	O	O	O	O
鼠标(如有)	O	O	O	O	O	O

O: 表明该有毒有害物质在该部件所有均质材料中的含量均在SJ/T11364-2014标准规定的限量要求之下。

X: 表示该有毒有害物质至少在该部件的某一均质材料中的含量超出SJ/T11364-2014标准规定的限量要求。

EFUP (对环境友好的使用时间): 30年。

使用条件：参阅用户手册“环境条件”部分的规定。

探头EFUP: 10年。

Part Name	Toxic or Hazardous Substances and Elements					
	Lead (Pb)	Mercury (Hg)	Cadmium (Cd)	Hexavalent Chromium (Cr6+)	Polybrominated Biphenyls (PBB)	Polybrominated Diphenyl Ethers (PBDE)
PCBAs	X	O	O	O	O	O
Mechanical Hardware	O	O	O	O	O	O
Sheet Metal	O	O	O	O	O	O
Plastic Parts	O	O	O	O	O	O
Cable Assemblies	X	O	O	O	O	O
Display	O	O	O	O	O	O
Power Supply	O	O	O	O	O	O
Fans	O	O	O	O	O	O
Batteries	O	O	O	O	O	O
Power Cord	O	O	O	O	O	O
Ext Power Supply (if present)	X	O	O	O	O	O
Probes (if present)	X	O	O	O	O	O
Fuse (if present)	O	O	O	O	O	O
Product Case (if present)	O	O	O	O	O	O
Adapters/Modules (if present)	O	O	O	O	O	O
Mouse (if present)	O	O	O	O	O	O
O: Indicates that this toxic or hazardous substance contained in all of the homogeneous materials for this part is below the limit requirement specified in SJ/T11364-2014.						
X: Indicates that this toxic or hazardous substance contained in at least one of the homogenous materials used for this part is above the limit requirement specified in SJ/T11364-2014.						

EFUP (Environmental Friendly Use Period): 30 years.

Use Conditions: Refer to the environmental conditions stated in the User Manual.

EFUP for Probes: 10 years.



Company Profile

Teledyne LeCroy is a leading provider of oscilloscopes, protocol analyzers and related test and measurement solutions that enable companies across a wide range of industries to design and test electronic devices of all types. Since our founding in 1964, we have focused on creating products that improve productivity by helping engineers resolve design issues faster and more effectively. Oscilloscopes are tools used by designers and engineers to measure and analyze complex electronic signals in order to develop high-performance systems and to validate electronic designs in order to improve time to market.

The Teledyne Test Tools brand extends the Teledyne LeCroy product portfolio with a comprehensive range of test equipment solutions. This new range of products delivers a broad range of quality test solutions that enable engineers to rapidly validate product and design and reduce time-to-market. Designers, engineers and educators rely on Teledyne Test Tools solutions to meet their most challenging needs for testing, education and electronics validation.

Location and Facilities

Headquartered in Chestnut Ridge, New York, Teledyne Test Tools and Teledyne LeCroy has sales, service and development subsidiaries in the US and throughout Europe and Asia. Teledyne Test Tools and Teledyne LeCroy products are employed across a wide variety of industries, including semiconductor, computer, consumer electronics, education, military/aerospace, automotive/industrial, and telecommunications.

Distributed by:

Teledyne LeCroy (US Headquarters)

700 Chestnut Ridge Road
Chestnut Ridge, NY, USA
10977-6499

Phone: 800-553-2769 or 845-425-2000

Fax Sales: 845-578-5985

Email Sales: contact.corp@teledynelecroy.com

Email Support: support@teledynelecroy.com

(Oscilloscopes, Waveform Generators, Signal Integrity)

Web Site: <http://teledynelecroy.com/>

Phone Support: 1-800-553-2769

Teledyne LeCroy (European Headquarters)

Teledyne LeCroy GmbH Im

Breitspiel 11c

D-69126 Heidelberg, Germany

Phone: + 49 6221 82700

Fax: +49 6221 834655

Fax Sales: +49 6221 834655

Fax Service: +41 22 719 22 99

Email Sales: contact.gmbh@teledynelecroy.com

Email Service: service.gmbh@teledynelecroy.com

Email Support: tlc.t3.appsupport.eu@teledyne.com

Web Site: <http://teledynelecroy.com>

Phone Service: +49 6221 8270 85

Phone Support: +49 6221 8270 28

T3DSO1000 / T3DSO1000A Data Sheet

Oscilloscopes

Debug with Confidence

100 MHz – 350 MHz

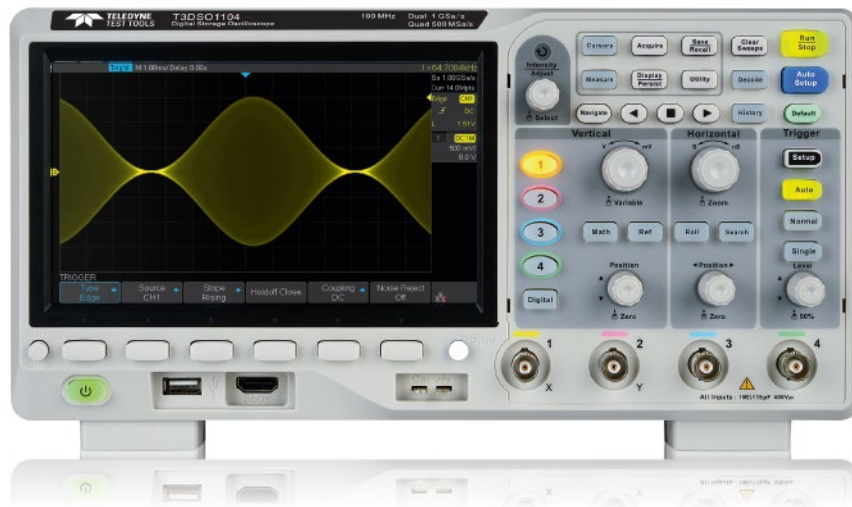

Tools for Improved Debugging

- **Long Capture** – Up to 28 Mpts interleaved.
 ✔ Capture more time and show more waveform detail.
- **Math and Measure** – 7 basic math functions plus FFT and 38 automatic measurement parameters.
 ✔ Extract results from waveforms and measurements.
- **Connectivity** – USB for mass storage, printing and PC control, plus LAN for fast data transfer.
 ✔ Save data for external analysis and screen images for reports.
- **Serial Bus Trigger and Decode** – I2C, SPI, UART, RS232, CAN, LIN.
 ✔ Debug serial buses directly in your Oscilloscope.
- **Waveform Sequence Recorder** – record and play back up to 80,000 waveforms.
 ✔ Replay the changing waveform history.
- **Optional MSO** – 16 Digital Channels (4 channel and A series only).
 ✔ Add mixed signal debugging to your Oscilloscope.

Key Specifications

Bandwidth	100 MHz, 200, 350 MHz
Channels	2 or 4
Memory	up to 14 Mpts/Ch (28 Mpts interleaved)
Sample Rate	up to 1 GS/s / 2 GS/s interleaved
Display	7" Bright TFT LCD (800 x 480)
Connectivity	USB Host, USB Device, LAN

PRODUCT OVERVIEW

T3DSO1102: 2 Channel 100 MHz

T3DSO1104: 4 Channel 100 MHz

T3DSO1202A: 2 Channel 200 MHz

T3DSO1204: 4 Channel 200 MHz

T3DSO1302A: 2 Channel 350 MHz

Teledyne Test Tools new T3DSO1000 Oscilloscopes feature two channel and four channel models. The two channel models are available with 100 MHz, 200 MHz and 350 MHz analog bandwidths, a single ADC with up to 2 GSa/s maximum sample rate, and memory up to 28 Mpts. The four channel scope is available in 100 and 200 MHz models and incorporates two 1 GSa/s ADCs and two 14 Mpts memory modules. When all channels are enabled, each channel has sample rate of 500 MSa/s, or 1 GS/s for the A series, and a standard record length of 7 Mpts, or 14 Mpts for the A Series. When only a single channel per ADC is active, the maximum sample rate and the maximum record length are doubled.

For ease-of-use, the most commonly used functions can be accessed with its user-friendly front panel design.

The T3DSO1000 series employs a new generation of high speed display technology that provides excellent signal clarity, fidelity and performance. The system noise floor is also lower than similar products in the industry. It comes with a minimum vertical input range of 500 uV/div, an innovative digital trigger system with high sensitivity and low jitter, and a waveform capture rate of 400,000 frames/sec (sequence mode). The T3DSO1000 also employs a 256-level intensity grading display function and a color temperature display mode not found in other models in this class. Teledyne Test Tools latest oscilloscope offering supports multiple powerful triggering modes including serial bus triggering. Serial bus decoding for IIC, SPI, UART, CAN, LIN bus types is included. The models also include History waveform recording, and sequential triggering that enable extended waveform recording and analysis.

Another powerful addition is the new 1 million point FFT math function that gives the T3DSO1000 very high frequency resolution when observing signal spectra. The new digital design also includes a hardware co-processor that delivers measurements quickly and accurately without slowing acquisition and front-panel response. The features and performance of Teledyne Test Tools T3DSO1000 family cannot be matched in this price class.

The four channel and A series includes even more functions, including: searching and navigating, on-screen Bode plot, 16 digital channels (Option), an external USB powered 25 MHz AWG module (Option), a USB WIFI adapter (Option), and an embedded application that allows remote control via web browser.

Key Features

- 100 MHz, 200 MHz and 350 MHz bandwidth models
- Two channel series have one ADC, four channel series have two ADCs. When all channels are enabled, each channel has a maximum sample rate of 500 MSa/s (1 Gsa/s for the A series). When a single channel per ADC is active, it has sample rate of 1 GSa/s (2 Gsa/s for the A Series)
- The newest generation of high speed display technology
 - Waveform capture rate up to 100,000 wfm/s (normal mode), and 400,000 wfm/s (sequence mode)
 - Supports 256-level intensity grading and color display modes Record length up to 28 Mpts
 - Digital trigger system
- Intelligent trigger: Edge, Slope, Pulse Width, Window, Runt, Interval, Time out (Dropout), Pattern
- Serial bus triggering and decoding (Standard), supports protocols IIC, SPI, UART, RS232, CAN, LIN
- Video trigger, supports HDTV
- Low background noise with voltage scales from 500 µV/div to 10 V/div
- 10 types of one-button shortcuts, supports Auto Setup, Default, Cursors, Measure, Roll, History, Display/Persist, Clear Sweep, Zoom and Print Segmented acquisition (Sequence) mode, divides the maximum record length into multiple segments (up to 80,000), according to trigger conditions set by the user, with a very small dead time segment to capture the qualifying event.
- History waveform record (History) function, maximum recorded waveform length is 80,000 frames.

Models and key Specification

Model	T3DSO1102 T3DSO1104	T3DSO1204	T3DSO1202A	T3DSO1302A
Bandwidth	100 MHz	200 MHz	200 MHz	350 MHz
SamplingRate (Max.)	Two channel series have a single 1 GSa/s ADC, four channel series have two 1 GSa/s ADCs. When all channels are enabled, each channel has a maximum sample rate of 500 MSa/s. When a single channel per pair is active, that channel has sample rate of 1 GSa/s		The A series has a single 2 GSa/s ADC. When both channels are enabled, each channel has a maximum sample rate of 1 GSa/s. When a single channel is active, that channel has sample rate of 2 GSa/s	
Channels	4, no EXT (T3DSO1104 and T3DSO1204 four channel series) 2+EXT (T3DSO1102, T3DSO1202A and T3DSO1302A two channel series)			
Memory Depth (Max.)	7 Mpts/CH (not interleave mode); 14 Mpts/CH (interleave mode)		14 Mpts/CH (not interleave mode); 28 Mpts/CH (interleave mode)	
Waveform Capture Rate (Max.)	100,000 wfm/s (normal mode), 400,000 wfm/s (sequence mode)			
Trigger Type	Edge, Slope, Pulse Width, Window, Runt, Interval, Dropout, Pattern, Video			
Serial Trigger and decoder (Standard)	IIC, SPI, UART/RS232, CAN, LIN			
16 Digital Channels (Option not available on the T3DSO1102)	Maximum waveform capture rate up to 1 GSa/s, Record length up to 14 Mpts/CH			
USB AWG module (Option not available on the T3DSO1102)	One channel, 25 MHz, sample rate of 125 MHz, wave length of 16 kpts			
Bode plot (Not available on the T3DSO1102)	Minimum start frequency of 10 Hz, minimum scan bandwidth of 500 Hz, maximum scan bandwidth of 120 MHz (dependent on Oscilloscope and AWG bandwidth), 500 maximum scan frequency points			
USB WIFI adapter (Option not available on the T3DSO1102)	802.11b/g/b, WPA-PSK, the adapter must be purchased separately by the scope user (TP-Link TL-WN725N)			
I/O	USB Host, USB Device, LAN, Pass/Fail, Trigger Out, Sbus (Teledyne Test Tools MSO)			
Probe (Std)	2/4 pcs passive probe		2 pcs passive probe	
Display	7 inch TFT-LCD (800 x 480)			
Weight	All models except T3DSO1102: Without package 2.6 Kg; With package 3.8 Kg T3DSO1102: Without package 2.5 Kg; With package 3.5 Kg			

- Automatic measurement function for 38 parameters as well as Measurement Statistics, Zoom, Gating, Math, History and Reference functions
- 1 Mpts FFT
- Math and measurement functions use all sampled data points (up to 28 Mpts)
- Math functions (FFT, addition, subtraction, multiplication, division, integration, differential, square root)
- Preset key can be customized for user settings or factory "defaults"
- Security Erase mode
- High Speed hardware based Pass/ Fail function
- MSO, 16 digital channels¹⁾
- Bode plot¹⁾
- Search and navigate¹⁾
- USB AWG module¹⁾
- USB WIFI adapter¹⁾
- Web Browser based control¹⁾
- Large 7 inch TFT-LCD display with 800 * 480 resolution
- Multiple interface types: USB Host, USB Device (USB-TMC), LAN, Trigger Out
- Supports SCPI remote control commands
- Supports Multi-language display and embedded online help

¹⁾ Not available on the T3DSO1102.

FUNCTION & CHARACTERISTICS

7 inch TFT-LCD display and 10 one-button menus



Front panel of T3DSO1104, T3DSO1202A, T3DSO1204, T3DSO1302A



Front panel of T3DSO1102

- 7-inch TFT-LCD display with 800 * 480 resolution
- Most commonly used functions are accessible using 10 different one-button operation keys: Auto Setup, Default, Cursor, Measure, Roll, History, Persist, Clear
- Sweep, Zoom, Print

Record Length of Up to 28 Mpts depending on model and channels (single channel/pair mode).

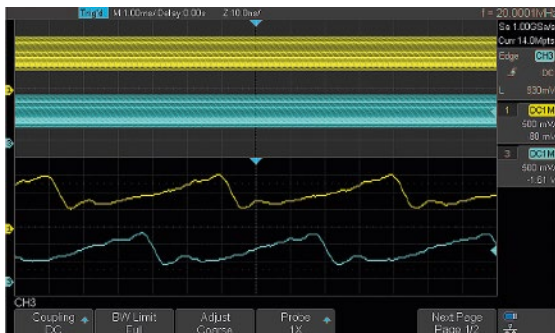

Using hardware-based Zoom technologies and max record length of up to 28 Mpts, users are able to over-sample to capture longer time periods at higher resolution and use the zoom feature to see more details within each signal.

When all channels are enabled, each channel has a maximum sample rate of up to 1 GSa/s (depending on the model)
When a single channel per pair is active, that channel has sample rate of up to 2 GSa/s (depending on the model)

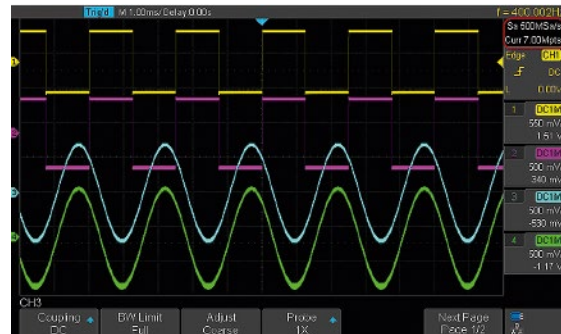
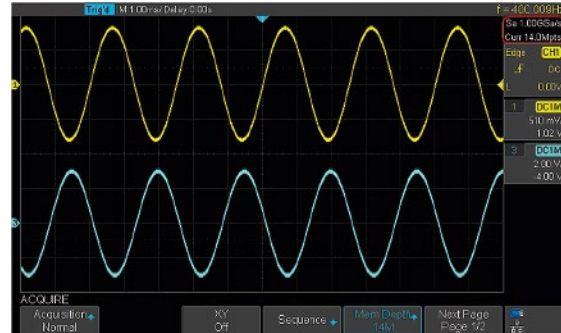

The four channel series has two 1 GSa/s ADC chips (channel 1 and 2 share one, channel 3 and 4 share another), so that each channel can achieve sample rates up to 500 MSa/s and work on bandwidths of 200 MHz when all channels are enabled.

Waveform Capture Rate Up to 400,000 wfms/s

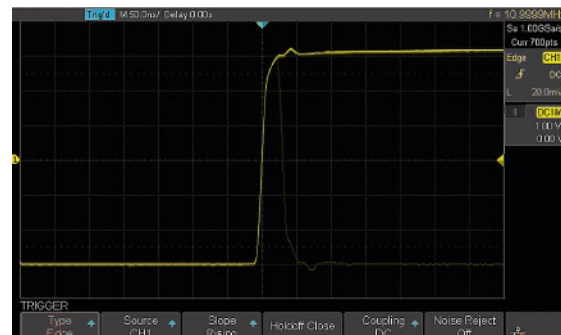

With a waveform capture rate of up to 400,000 wfms/s (sequence mode), the oscilloscope can easily capture the unusual or low-probability events.

256-Level Intensity Grading and Color Temperature Display

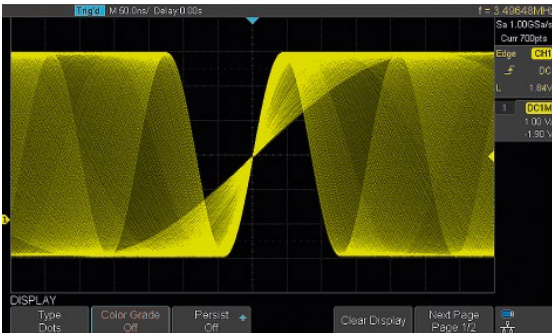

New display technology provides for fast refresh rates. The resulting intensity-graded trace is brighter for events that occur with more frequency and dims when the events occur with less frequency.

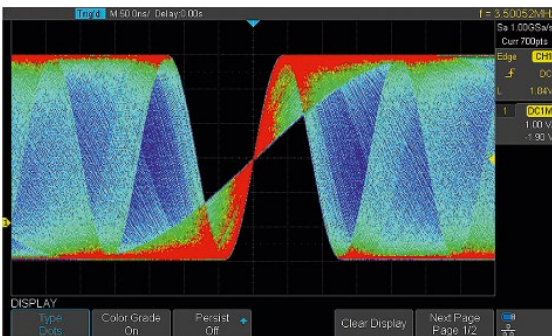

The color temperature display is similar to the intensity-graded trace function, but the trace occurrence is represented by different colors (color "temperature") as opposed to changes in the intensity of one color. Red colors represents the more frequent events, while blue is used to mark points that occur least frequently.

Serial Bus Decoding Function (Standard)

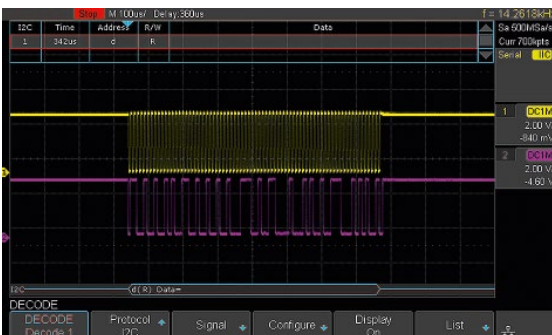

T3DSO1000 displays the decoding through the events list. Bus protocol information can be quickly and intuitively displayed in a tabular format.

History Waveforms (History) Mode and Segmented Acquisition (Sequence)

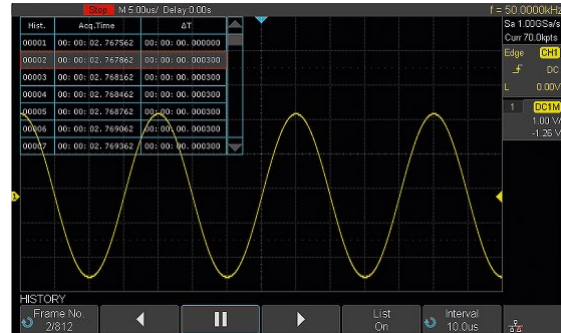

Playback the latest triggered events using the history function. Segmented memory collection will store trigger events into multiple (Up to 80,000) memory segments, each segment will store triggered waveforms and timestamp each frame.

True measurement to 14 M points or 28 M points depending on the model

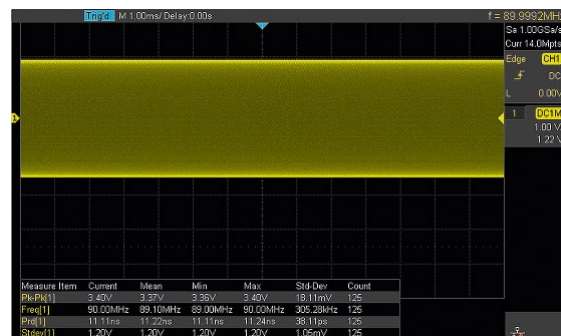

At any one timebase, T3DSO1000 can measure using all acquired sample points. This ensures the accuracy of measurements while the math coprocessor decreases measurement time and increases ease-of-use.

Gate and Zoom Measurement



Through Gate and Zoom measurement, the user can specify an arbitrary interval of waveform data analysis and statistics. This helps avoid measurement errors that can be caused by invalid or extraneous data, greatly enhancing the measurements' validity and flexibility.

FUNCTION & CHARACTERISTICS

1 M points FFT

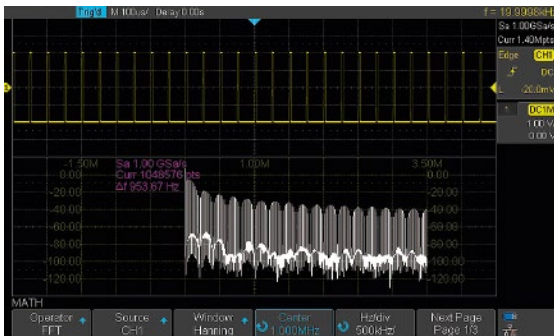

The math co-processor enables FFT analysis of incoming signals using up to 1 M samples per waveform. This provides high frequency resolution with a fast refresh rate. The FFT function also supports a variety of window functions so that it can adapt to different spectrum measurement needs.

Hardware-Based High Speed Pass/Fail function

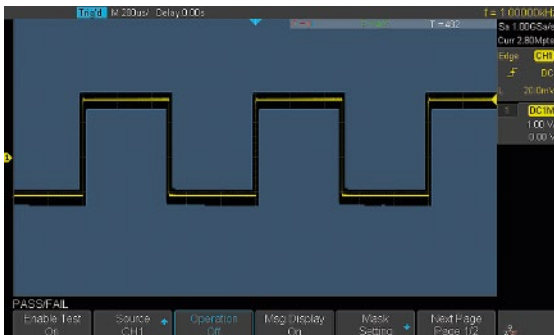

The T3DS01000 utilizes a hardware-based Pass/Fail function, performing up to 40,000 Pass/Fail decisions each second. Easily generate user defined test templates provide trace mask comparison making it suitable for long-term signal monitoring or automated production line testing.

Customizable Default Key

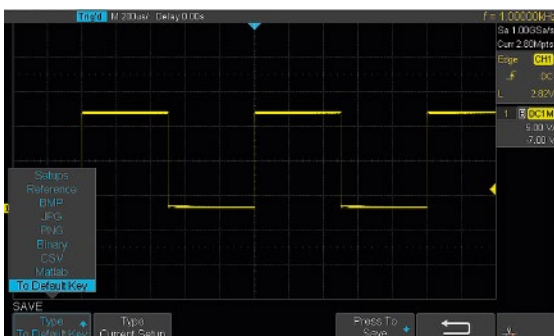

The current parameters of the oscilloscope can be preset to Default Key through the Save menu.

16 Digital Channels/MSO (Option not available on the T3DS01102)

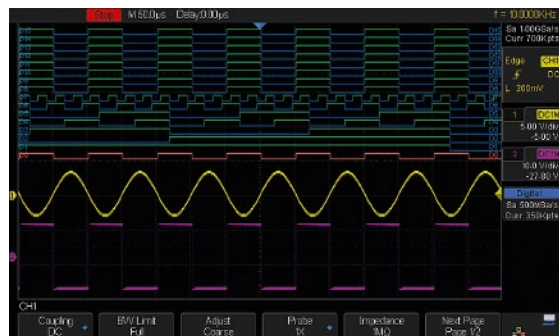

16 digital channels enables users to acquire and trigger on the waveforms then analyze the pattern, simultaneously with one instrument. Color coded logic levels clearly differentiate high and low states.

Search and Navigate (not available on the T3DS01102)

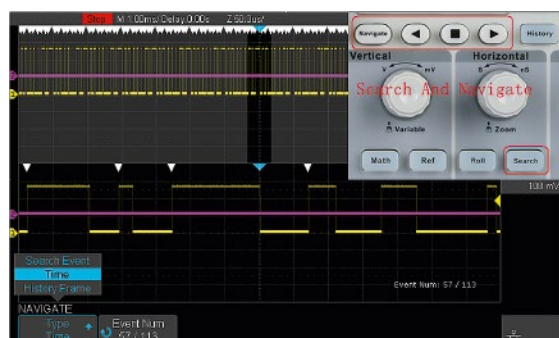
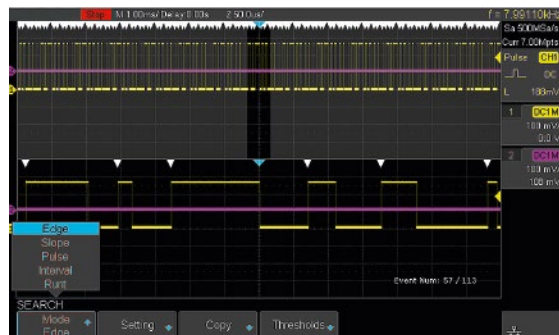

The T3DS01000 series can search events specified by the user in a frame. It can also navigate by time (delay position) and historical frames. Search and Navigate is not available on the T3DS01102.

Bode Plot (not available on the T3DSO1102)

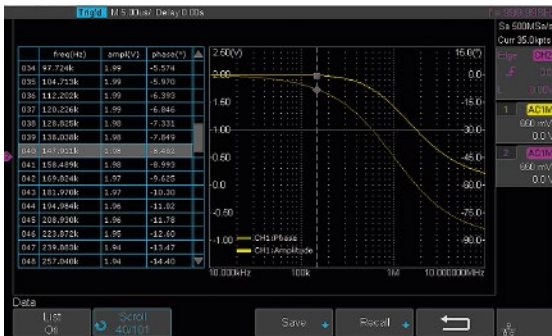
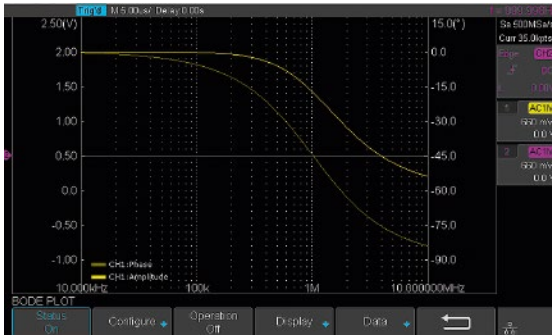

T3DSO1000 can control the USB AWG module, control an independent Teledyne Test Tools T3AFG instrument, scan an object's amplitude and phase frequency response, and display the data as a Bode Plot. It can also show the result lists, and export the data to a USB disk. Not available for the T3DSO1102.

USB WiFi Adapter (Option not available on the T3DSO1102)

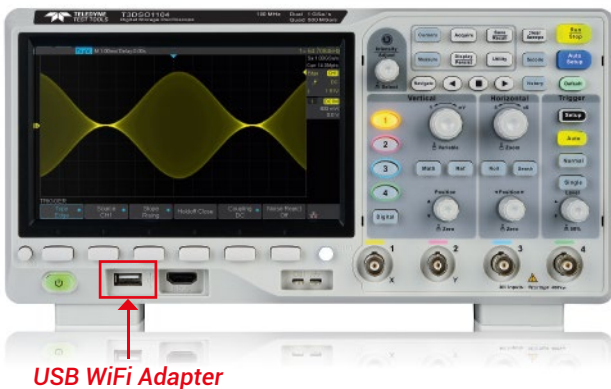

WiFi control of instrumentation can provide a convenient and safe method of configuring and collecting data. This new feature works with a Teledyne Test Tools approved WiFi adapter to provide wireless control and communications with Teledyne Test Tools 4 channel scopes. Option not available for the T3DSO1102. The approved adapter is the TP-Link TL-WN725N (not supplied).

USB 25 MHz AWG Module (Option not available on the T3DSO1102)



The T3DSO1000 series supports an optional USB 25 MHz function/arbitrary waveform generator that is operated from the USB host connection. Functions include Sine, Square, Ramp, Pulse, Noise, DC and 45 built-in waveforms. The arbitrary waveforms can be accessed and edited by the Teledyne Test Tools PC software. Option not available for the T3DSO1102.

Complete Connectivity



Back panel of T3DSO1104, T3DSO1202A, T3DSO1204, T3DSO1302A



Back panel of T3DSO1102

T3DSO1000 supports USB Host, USB Device (USB-TMC), LAN(VXI-11), Pass/Fail and Trigger Out.

Web control (not available on the T3DSO1102)



With the new embedded web server, users can control the Oscilloscopes from a simple web page. This provides remote troubleshooting and monitoring capabilities.

SPECIFICATIONS

Model	T3DSO1102, T3DSO1104, T3DSO1204	T3DSO1202A, T3DSO1302A
-------	---------------------------------	------------------------

Acquire System

Sampling Rate	1 GSa/s (single channel/pair), 500 MSa/s (two channels/pair)	2 GSa/s (single channel), 1 GSa/s (two channels)
Memory Depth	Max 14 Mpts/Ch (single channel/pair), 7 Mpts/Ch (two channels/pair)	Max 28 Mpts/Ch (single channel), 14 Mpts/Ch (two channels)
Peak Detect	2 nsec (Four channel series) 4 nsec (Two channel series)	1 nsec
Average	Averages: 4, 16, 32, 64, 128, 256, 512, 1024	
Eres	Enhance bits: 0.5, 1.5, 2, 2.5, 3; Selectable	
Waveform interpolation	Sin(x)/x, Linear	

Input

Channels	4, no EXT (four channel series) 2+EXT (two channel series)	2+EXT
Coupling	DC, AC, GND	
Impedance	DC: (1 M Ω \pm 2 %) (15 pF \pm 2 pF) (Four channel series) DC: (1 M Ω \pm 2 %) (18 pF \pm 2 pF) (Two channel series)	DC: (1 M Ω \pm 2 %) (18 pF \pm 2 pF) DC: (50 Ω \pm 2 %)
Max. Input voltage	1 M Ω \leq 400 Vpk (DC + Peak AC \leq 10 kHz)	1 M Ω \leq 400 Vpk (DC + Peak AC \leq 10 kHz) DC: 50 Ω : $<$ 5V rms
CH to CH Isolation	DC-Max BW $>$ 40 dB	
Probe attenuation	0.1X, 0.2X, 0.5X, 1X, 2X, 5X, 10X.....1000X, 2000X, 5000X, 10000X	

Vertical System

Bandwidth (-3 dB)	200 MHz (T3DSO1204) / T3DSO1202A 350 MHz (T3DSO1302A) 100 MHz (T3DSO1102 / T3DSO1104)	
Vertical Resolution	8-bit	
Vertical Scale (Probe 1X)	500 μ V/div – 10 V/div (1-2-5 sequence)	
Offset Range (Probe 1X)	500 μ V – 118 mV: \pm 2 V 120 mV – 1.18 V: \pm 20 V 1.2 V – 10 V: \pm 200 V	500 μ V – 100 mV: \pm 2 V 102 mV – 1 V: \pm 20 V 1.02 V – 10 V: \pm 200 V
Bandwidth Limit	20 MHz \pm 40 %	
Bandwidth Flatness	DC – 10 % (BW): \pm 1 dB 10 % – 50 % (BW): \pm 2 dB 50 % – 100 % (BW): \pm 2 dB/ -3 dB	DC – 60 % (BW): \pm 1 dB 60 % – 100 % (BW): \pm 1 dB/ -3 dB
Low Frequency Response (AC -3 dB)	\leq 10 Hz (at input BNC)	
Noise	ST-DEV \leq 0.5 division ($<$ 1 mV/div) ST-DEV \leq 0.2 division ($<$ 2 mV/div) ST-DEV \leq 0.1 division (\geq 2 mV/div)	
SFDR including harmonics	\geq 35 dB	
DC Gain Accuracy	\leq \pm 3.0%: 5 mV/div – 10 V/div \leq \pm 4.0%: \leq 2 mV/div	
Offset Accuracy	\pm (1 % * Offset + 1.5 % * 8 * div + 2 mV): \geq 2 mV/div \pm (1 % * Offset + 1.5 % * 8 * div + 500 μ V): \leq 1 mV/div	
Risetime	Typical 1.0 ns (T3DSO1302A) Typical 1.8 ns (T3DSO1202A / T3DSO1204) Typical 3.5 ns (T3DSO1102 / T3DSO1104)	
Overshoot (500 ps Pulse)	$<$ 10 %	

Horizontal System

Timebase Scale	1.0 ns/div – 100 s/div	500 ps/div – 100 s/div
Channel Skew	$<$ 100 ps	
Waveform Capture Rate	Up to 100,000 wfm/s (normal mode), 400,000 wfm/s (sequence mode)	
Intensity grading	256 Levels	
Display Format	Y-T, X-Y, Roll	
Timebase Accuracy	\pm 25 ppm	
Roll Mode	50 ms/div – 100 s/div (1-2-5 step)	

Model	T3DSO1102, T3DSO1104, T3DSO1204	T3DSO1202A, T3DSO1302A
--------------	--	-------------------------------

Trigger System

Trigger Mode	Auto, Normal, Single	
Trigger Level	Internal: ± 4.5 div from the center of the screen EXT: ± 0.6 V (Two channel series) EXT/5: ± 3 V (Two channel series)	
Holdoff Range	80 ns – 1.5 s	
Trigger Coupling	AC DC LFRJ HFRJ Noise RJ	
Coupling Frequency Response	DC: Passes all components of the signal AC: Blocks DC components and attenuates signals below 8 Hz LFRJ: Blocks the DC component and attenuates the low-frequency components below 2 MHz HFRJ: Attenuates the high-frequency components above 1.2 MHz	
Coupling Frequency Response (EXT)	DC: Passes all components of the signal AC: Blocks DC components and attenuates signals below 20 Hz LFRJ: Blocks the DC component and attenuates the low-frequency components below 7 KHz HFRJ: Attenuates the high-frequency components above 160 KHz	DC: Passes all components of the signal AC: Blocks DC components and attenuates signals below 10 Hz LFRJ: Blocks the DC component and attenuates the low-frequency components below 6 KHz HFRJ: Attenuates the high-frequency components above 200 KHz
Trigger Accuracy (Typical)	Internal: ± 0.2 div EXT (Two channel series): ± 0.4 div	
Trigger Sensitivity	DC – Max BW 0.6 div EXT (Two channel series): 200 mVpp DC – 10 MHz 300 mVpp 10 MHz – BW frequency EXT/5 (Two channel series): 1 Vpp DC – 10 MHz 1.5 Vpp 10 MHz – BW frequency	
Trigger Jitter	< 100 ps	
Trigger Displacement	Pre-Trigger: 0 – 100 % Memory Delay Trigger: 0 to 10,000 div	

Edge Trigger

Slope	Rising, Falling, Rising & Falling
Source	All channels/ EXT/ (EXT/5)/ AC Line (Two channel series) All channels/ AC Line (Four channel series)

Slope Trigger

Slope	Rising, Falling
LimitRange	< , > , < > , > <
Source	All channels
TimeRange	2 ns – 4.2 s
Resolution	1 ns

Pulse Trigger

Polarity	+wid , -wid
Limit Range	< , > , < > , > <
Source	All channels
Pulse Range	2 ns ~ 4.2 s
Resolution	1 ns

Video Trigger

Signal Standard	NTSC, PAL, 720p/50, 720p/60, 1080p/50, 1080p/60, 1080i/50, 1080i/60, Custom
Source	All channels
Sync	Any, Select
Trigger condition	Line, Field

SPECIFICATIONS

Window Trigger

Window Type	Absolute, Relative
Source	All channels

Interval Trigger

Slope	Rising, Falling
Limit Range	<, >, <>, ><
Source	All channels
Time Range	2 ns ~ 4.2 s
Resolution	1 ns

Dropout Trigger

Timeout Type	Edge, State
Source	All channels
Slope	Rising, Falling
Time Range	2 ns ~ 4.2 s
Resolution	1 ns

Runt Trigger

Polarity	+wid, -wid
Limit Range	<, >, <>, ><
Source	All channels
Time Range	2 ns ~ 4.2 s
Resolution	1 ns

Pattern Trigger

Pattern Setting	Invalid, Low, High
Logic	AND, OR, NAND, NOR
Source	All channels
Limit Range	<, >, <>, ><
Time Range	2 ns ~ 4.2 s
Resolution	1 ns

Serial Trigger

I2C Trigger

Condition	Start, Stop, Restart, No Ack, EEPROM, 7 bits Address & Data, 10 bits Address & Data, Data Length
Source (SDA/SCL)	All channels
Data format	Hex
Limit Range	EEPROM: =, >, <
Data Length	EEPROM: 1 byte Addr & Data: 1 ~ 2 byte Data Length: 1 ~ 12 byte
R/W bit	Addr & Data: Read, Write, Don't care

SPI Trigger

Condition	Data
Source (CS/CL/Data)	All channels
Data format	Binary
Data Length	4 ~ 96 bit
Bit Value	0, 1, X
Bit Order	LSB, MSB

UART / RS232 Trigger	
Condition	Start, Stop, Data, Parity Error
Source (RX/TX)	All channels
Data format	Hex
Limit Range	=, >, <
Data Length	1 byte
Data Width	5 bit, 6 bit, 7 bit, 8 bit
Parity Check	None, Odd, Even
Stop Bit	1 bit, 1.5 bit, 2 bit
Idle Level	High, Low
Baud (Selectable) (Custom)	600/1200/2400/4800/9600/19200/38400/57600/115200 bit/s 300 bit/s ~ 5,000,000 bit/s
CAN Trigger	
Condition	Start, Remote, ID, ID + Data, Error
Source	All channels
ID	STD (11 bit), EXT (29 bit)
Data Format	Hex
Data Length	1~2 byte
Baud Rate (Selectable)	5 k/10 k/20 k/50 k/100 k/125 k/250 k/500 k/800 k/1 M bit/s
LIN Trigger	
Condition	Break, Frame ID, ID+Data, Error
Source	All channels
ID	1 byte
Data Format	Hex
Data Length	1 ~ 2 byte
Baud Rate (Selectable)	600/1200/2400/4800/9600/19200 bit/s
Baud Rate (Custom)	300 bit/s ~ 20 kbit/s

Serial Decoder

I2C Decoder	
Signal	SCL, SDA
Address	7 bits, 10 bits
Threshold	-4.5 ~ 4.5 div
List	1 ~ 7 lines
SPI Decoder	
Signal	SCL, MISO, MOSI, CS * NOTE 2 channel scopes can only use 2 signal identifiers
Edge Select	Rising, Falling
Idle Level	Low, High
Bit Order	MSB, LSB
Threshold	-4.5 ~ 4.5 div
List	1 ~ 7 lines
UART / RS232 Decoder	
Signal	RX, TX
Data Width	5 bit, 6 bit, 7 bit, 8 bit
Parity Check	None, Odd, Even
Stop Bit	1 bit, 1.5 bit, 2 bit
Idle Level	Low, High
Threshold	-4.5 ~ 4.5 div
List	1 ~ 7 lines
CAN Decoder	
Signal	CAN_H, CAN_L
Source	CAN_H, CAN_L, CAN_H-CAN_L
Threshold	-4.5 ~ 4.5 div
List	1 ~ 7 lines
LIN Decoder	
LIN Specification Package Revision	Ver1.3, Ver2.0
Threshold	-4.5 ~ 4.5 div
List	1 ~ 7 lines

SPECIFICATIONS

Measurement

Source	All channels, All channels in Zoom, Math, All References, History		
Number of Measurements	Display 5 measurements at the same time		
Measurement Range	Screen region, Gate region		
Measurement Parameters (38 Types)			
Vertical (Voltage)	Max	Highest value in input waveform	
	Min	Lowest value in input waveform	
	Pk-Pk	Difference between maximum and minimum data values	
	Ampl	Difference between top and base in a bimodal signal, or between max and min in a unimodal signal	
	Top	Value of most probable higher state in a bimodal waveform	
	Base	Value of most probable lower state in a bimodal waveform	
	Mean	Average of all data values	
	Cmean	Average of data values in the first cycle	
	Stdev	Standard deviation of all data values	
	Cstd	Standard deviation of all data values in the first cycle	
	VRMS	Root mean square of all data values	
	Crms	Root mean square of all data values in the first cycle	
	FOV	Overshoot after a falling edge; (base-min)/Amplitude	
	FPRE	Overshoot before a falling edge; (max-top)/Amplitude	
	ROV	Overshoot after a rising edge; (max-top)/Amplitude	
	RPRE	Overshoot before a rising edge; (base-min)/Amplitude	
Level@X	the voltage value of the trigger point		
Horizontal(Time)	Period	Period for every cycle in waveform at the 50 % level, and positive slope	
	Freq	Frequency for every cycle in waveform at the 50 % level, and positive slope	
	+Wid	Width measured at 50 % level and positive slope	
	-Wid	Width measured at 50 % level and negative slope	
	Rise Time	Duration of rising edge from 10 – 90 %	
	Fall Time	Duration of falling edge from 90 – 10 %	
	Bwid	Time from the first rising edge to the last falling edge, or the first falling edge to the last rising edge at the 50 % crossing	
	+Dut	Ratio of positive width to period	
	-Dut	Ratio of negative width to period	
	Delay	Time from the trigger to the first transition at the 50 % crossing	
	Time@Level	Time from the trigger to each rising edge at the 50 % crossing. When Statistics is Off, it shows the time from the trigger to the last rising edge at the 50 % crossing. When Statistics is On, it shows the Current, Mean, Min, Max, Standard Deviation of time from the trigger to each rising edge at the 50 % crossing in multiple frames (number = Count).	
	Delay	Phase	Calculate the phase difference between two edges
		FRR	Time between the first rising edges of the two channels
FRF		Time from the first rising edge of channel A to the first falling edge of channel B	
FFR		Time from the first falling edge of channel A to the first rising edge of channel B	
FFF		Time from the first falling edge of channel A to the first falling edge of channel B	
LRR		Time from the first rising edge of channel A to the last rising edge of channel B	
LRF		Time from the first rising edge of channel A to the last falling edge of channel B	
LFR		Time from the first falling edge of channel A to the last rising edge of channel B	
LFF		Time from the first falling edge of channel A to the last falling edge of channel B	
Skew		Time of source A edge minus time of nearest source B edge	
Cursors		Manual : Time X1, X2, (X1-X2), (1/ΔT) Voltage Y1, Y2, (Y1-Y2) Track: Time X1, X2, (X1-X2)	
Statistics	Current, Mean, Min, Max, Stdev, Count		
Counter	Hardware 6 bit counter(channels are selectable)		

Math Function

Operation	+ , - , * , / , FFT , d/dt , fdt , √
FFT window	Rectangular, Blackman, Hanning, Hamming, Flattop
FFT display	Full Screen, Split, Exclusive
Number of Decoders	2

USB AWG Module (Not available on the T3DSO1102)

Channel	1
Max. Output Frequency	25 MHz
Sampling Rate	125 MSa/s
Frequency Resolution	1 μHz
Frequency Accuracy	± 50 ppm
Vertical Resolution	14-bits
Amplitude Range	-1.5 ~ +1.5 V (50 Ω) -3 ~ +3 V (High-Z)
Waveform Type	Sine, Square, Ramp, pulse, Noise, DC and 45 built-in waveforms
Output impedance	50 Ω ± 2 %
Protection	Over-Voltage Protection, Current-Limiting Protection

Sine

Frequency	1 μHz ~ 25 MHz
Offset Accuracy (10 kHz)	± (1 % * Offset Setting Value + 1 mVpp)
Amplitude flatness (10 kHz, 5 Vpp)	± 0.3 dB
SFDR	DC ~ 1 MHz -60 dBc 1 MHz ~ 5 MHz -55 dBc 5 MHz ~ 25 MHz -50 dBc
HD	DC ~ 5 MHz -50 dBc 5 MHz ~ 25 MHz -45 dBc

Square/Pulse

Frequency	1 μHz ~ 10 MHz
Duty Cycle	1 % ~ 99 %
Rise/Fall time	< 24 ns (10 % ~ 90 %)
Overshoot (1 kHz, 1 Vpp, Typical)	< 3 % (typical 1 kHz, 1 Vpp)
Pulse Width	> 50 ns
Jitter	< 500 ps + 10 ppm

Ramp

Frequency	1 μHz ~ 300 kHz
Linearity (Typical)	< 0.1 % of Pk-Pk (Typical, 1 kHz, 1 Vpp, 100 % Symmetry)
Symmetry	0 % ~ 100 % (Adjustable)

DC

Offset range	± 1.5 V (50 Ω) ± 3 V (High-Z)
Accuracy	± (offset * 1 % + 3 mV)

Noise

Bandwidth	> 25 MHz (-3 dB)
-----------	------------------

Arbitrary Wave

Frequency	1 μHz ~ 5 MHz
Wave Length	16 kpts
Sampling Rate	125 MSa/s
Waveform Entry	EasyScope and USB-Stick

SPECIFICATIONS

Digital Channels (Not available on the T3DSO1102)

No. of Channels	16
Max. Sampling Rate	1 GSa/s
Memory Depth	14 Mpts/CH
Min. Detectable Pulse Width	4 ns
Level Group	D0~D7, D8~D15
Level Range	-8 V ~ 8 V
Logic Type	TTL, CMOS, LVCMOS3.3, LVCMOS2.5, custom
Skew[2]	D0~D15: ± 1 sampling interval Analog To Digital: $\pm (1 \text{ sampling interval} + 1 \text{ ns})$

I/O

Standard	USB Host, USB Device, LAN, Pass/Fail, Trigger Out
Pass/Fail	3.3 V TTL Output

Display (Screen)

Display Type	7-inch TFT LCD
Display Resolution	800 × 480
Display Color	24 bit
Contrast (Typical)	500:1
Backlight	300 nit
Range	8 x 14 divisions

Display (Waveform)

Display Mode	Dot, Vector
Persist Time	Off, 1 Sec, 5 Sec, 10 Sec, 30 Sec, Infinite
Color Display	Normal, Color
Screen Saver	1 min, 5 min, 10 min, 30 min, 1 hour, Off
Language	Simplified Chinese, Traditional Chinese, English, French, Japanese, Korean, German, Russian, Italian, Portuguese

Environments

Temperature	Operating: 10 ~ +40 Non-operating: -20 ~ +60
Humidity	Operating: 85 % RH, 40 Deg C, 24 hours Non-operating: 85 % RH, 65 Deg C, 24 hours
Height	Operating: $\leq 3000 \text{ m}$ Non-operating: $\leq 15,266 \text{ m}$
Electromagnetic Compatibility	2004/108/EC Execution Standard EN 61326-1:2006 EN 61000-3-2:2006 + A2:2009, EN 61000-3-3:2008
Safety	2006/95/EC Execution Standard EN 61010-1:2010 / EN 61010-2-030:2010

Power Supply

Input Voltage	100 ~ 240 VAC, CAT II, Auto selection
Frequency	50/60/400 Hz
Power	50 W Max

Mechanical (T3DSO1104, T3DSO1204, T3DSO1202A, T3DSO1302A)



Dimensions	Length: 312 mm / Width: 132.6 mm / Height: 151 mm
Weight	N.W: 2.6 kg; G.W: 3.8 kg

Mechanical (T3DSO1102)

Dimensions	Length: 312 mm / Width: 134 mm / Height: 150 mm
Weight	N.W: 2.5 Kg; G.W: 3.5 Kg

All T3DSO1000 Series Oscilloscopes come with a 3 year return to Teledyne LeCroy warranty.

Probes and Accessories

Probe	Model	Picture	Description
Passive Probes (T3DSO1102, T3DSO1104, T3DSO1202A, T3DSO1204)	T3PP300		Passive Probe, Bandwidth: 300 MHz
Passive Probes (T3DSO1302A)	T3PP350		Passive Probe, Bandwidth: 350 MHz
USB AWG Module	T3DSO1000- FGMOD		Output Sine, Square, Ramp, pulse, Noise, DC and 45 built-in waveforms. The arbitrary waveforms can be accessed and edited by the EasyScope PC software

Ordering information

Product Name	T3DSO1102 100 MHz Two Channels	
	T3DSO1104 100 MHz Four Channels	
	T3DSO1202A 200 MHz Two Channels	
	T3DSO1204 200 MHz Four Channels	
	T3DSO1302A 350 MHz Two Channels	
Standard Accessories	USB Cable -1	
	Quick Start -1	
	Passive Probe -4 / 2	
	Certification -1	
	Power Cord -1	
Optional Accessories	16 Channel MSO Software (Not available for T3DSO1102)	T3DSO1000-MSO or T3DSO1000A-MSO
	16 Channel Logic Analyzer Lead (Not available for T3DSO1102)	T3DSO1000-LS (Requires T3DSO1000-MSO or T3DSO1000A-MSO Software)
	AWG Software (Not available for T3DSO1102)	T3DSO1000-FG or T3DSO1000A-FG
	USB AWG Module Hardware (Not available for T3DSO1102)	T3DSO1000-FGMOD (Requires T3DSO1000-FG or T3DSO1000A-FG)
	WIFI Software (Not available for T3DSO1102) Does not include the TP-Link TL-WN725N, see below	T3DSO1000-WIFI or T3DSO1000A-WIFI

For Wi-Fi support the T3DSO1000-WIFI/T3DSO1000A-WIFI option is required and the TP-Link TL-WN725N. The TP-Link TL-WN725N is NOT supplied as part of the T3DSO1000-WIFI/T3DSO1000A-WIFI option. The TP-Link TL-WN725N is not available through Teledyne Test Tools and should be purchased separately.

ABOUT TELEDYNE TEST TOOLS



Company Profile

Teledyne LeCroy is a leading provider of oscilloscopes, protocol analyzers and related test and measurement solutions that enable companies across a wide range of industries to design and test electronic devices of all types. Since our founding in 1964, we have focused on creating products that improve productivity by helping engineers resolve design issues faster and more effectively. Oscilloscopes are tools used by designers and engineers to measure and analyze complex electronic signals in order to develop high-performance systems and to validate electronic designs in order to improve time to market.

The Teledyne Test Tools brand extends the Teledyne LeCroy product portfolio with a comprehensive range of test equipment solutions. This new range of products delivers a broad range of quality test solutions that enable engineers to rapidly validate product and design and reduce time-to-market. Designers, engineers and educators rely on Teledyne Test Tools solutions to meet their most challenging needs for testing, education and electronics validation.

Location and Facilities

Headquartered in Chestnut Ridge, New York, Teledyne Test Tools and Teledyne LeCroy has sales, service and development subsidiaries in the US and throughout Europe and Asia. Teledyne Test Tools and Teledyne LeCroy products are employed across a wide variety of industries, including semiconductor, computer, consumer electronics, education, military/aerospace, automotive/industrial, and telecommunications.

Distributed by:

Teledyne LeCroy (US Headquarters)

700 Chestnut Ridge Road
Chestnut Ridge, NY. USA 10977-6499

Phone: 800-553-2769 or 845-425-2000
Fax Sales: 845-578-5985
Phone Support: 1-800-553-2769
Email Sales: contact.corp@teledynelecroy.com
Email Support: support@teledynelecroy.com
Web Site: <http://teledynelecroy.com/>

World wide support contacts can be found at:
<https://teledynelecroy.com/support/contact>

World wide instrument service can be found at:
<https://teledynelecroy.com/support/service.aspx>

RoHS and WEEE information can be found at:
<https://teledynelecroy.com/support/rohs.aspx>

Teledyne LeCroy (European Headquarters)

Teledyne LeCroy GmbH
Im Breitenspiel 11c
D-69126 Heidelberg, Germany

Phone: +49 6221 82700
Fax: +49 6221 834655
Phone Service: +49 6221 8270 85
Phone Support: +49 6221 8270 28
Email Sales: contact.gmbh@teledynelecroy.com
Email Service: service.gmbh@teledynelecroy.com
Email Support: tlc.t3.appsupport.eu@teledyne.com
Web Site: <http://teledynelecroy.com/>

teledynelecroy.com

