

General Warranty

OWON warrants that the product will be free from defects in materials and workmanship for a period of 3 years (1 year for accessories) from the date of purchase of the product by the original purchaser from the OWON Company. This warranty only applies to the original purchaser and is not transferable to the third party.

If the product proves defective during the warranty period, OWON either will repair the defective product without charge for parts and labor, or will provide a replacement in exchange for the defective product. Parts, modules and replacement products used by OWON for warranty work may be new or reconditioned like new performance. All replaced parts, modules and products become the property of OWON.

In order to obtain service under this warranty, customer must notify OWON of the defect before the expiration of the warranty period. Customer shall be responsible for packaging and shipping the defective product to the service center designated by OWON, and with a copy of customer proof of purchase.

This warranty shall not apply to any defect, failure or damage caused by improper use or improper or inadequate maintenance and care. OWON shall not be obligated to furnish service under this warranty a) to repair damage resulting from attempts by personnel other than OWON representatives to install, repair or service the product; b) to repair damage resulting from improper use or connection to incompatible equipment; c) to repair any damage or malfunction caused by the use of non-OWON supplies; or d) to service a product that has been modified or integrated with other products when the effect of such modification or integration increases the time or difficulty of servicing the product.

Please contact the nearest OWON's Sales and Service Offices for services.

For better after-sales service, please visit www.owon.com and register the purchased product online.

Excepting the after-sales services provided in this summary or the applicable warranty statements, OWON will not offer any guarantee for maintenance definitely declared or hinted, including but not limited to the implied guarantee for marketability and special-purpose acceptability. OWON should not take any responsibilities for any indirect, special or consequent damages.

For more details, please refer to the user manual on the supplied CD, it can also be downloaded at www.owon.com.

Table of Contents

1.General Safety Requirement	1
2.Safety Terms and Symbols.....	2
3.General Inspection.....	3
4.Quick Start	4
Front panel overview	4
Rear Panel Overview	6
Power on	7
User Interface	8
Use build-in Help.....	9
Set the channel	9
Set basic waveform	9
Output the build-in waveform (including DC)	11
Edit the arbitrary waveform.....	11
Generate the Modulated Waveform.....	12
Generate Sweep.....	13
Generate Burst	13
Counter	14
File Store System.....	15
Save the current arbitrary wave	15
Bring up arbitrary wave files in internal/external memory	16
Erase waveforms from memory	16
Save/recall instrument setup.....	17
Utility Setting	17
5.Communicate with PC.....	19
Using USB Port.....	19
Using LAN Port	19
Connect Directly.....	19
Connect through a Router.....	20
6.Appendix.....	22
Appendix A: Accessories	22
Appendix B: General Care and Cleaning.....	22

1. General Safety Requirement

Before any operations, please read the following safety precautions to avoid any possible bodily injury and prevent this product or any other products connected from damage. In order to avoid any contingent danger, this product is only used within the range specified.

Use Proper Power Cord. Use only the power cord supplied with the product and certified to use in your country.

Product Grounded. This instrument is grounded through the power cord grounding conductor. To avoid electric shock, the grounding conductor must be grounded. The product must be grounded properly before any connection with its input or output terminal.

Limit operation to the specified measurement category, voltage, or amperage ratings.

Check all Terminal Ratings. To avoid instrument damage and the risk of electric shock, check all the Measurement Limits and markers of this product. Refer to the user's manual for the Measurement Limits before connecting to the instrument. Do not exceed any of the Measurement Limits defined in the following section.

Do not operate without covers. Do not operate the instrument with covers or panels removed.

Use Proper Fuse. Use only the specified type and rating fuse for this instrument.

Avoid exposed circuit. Do not touch exposed junctions and components when the instrument is powered.

Do not operate if in any doubt. If you suspect damage occurs to the instrument, have it inspected by qualified service personnel before further operations.

Use your instrument in a well-ventilated area. Inadequate ventilation may cause increasing of temperature or damages to the device. Please keep well ventilated and inspect the intake regularly.

Do not operate in wet conditions. In order to avoid short circuiting to the interior of the device or electric shock, please do not operate in a humid environment.

Do not operate in an explosive atmosphere.

Keep product surfaces clean and dry.

Only the qualified technicians can implement the maintenance.

2. Safety Terms and Symbols

Terms in this Manual. The following terms may appear in this manual:

Warning: Warning indicates the conditions or practices that could result in injury or loss of life.

Caution: Caution indicates the conditions or practices that could result in damage to this product or other property.

Terms on the Product. The following terms may appear on this product:

Danger: It indicates an injury or hazard may immediately happen.

Warning: It indicates an injury or hazard may be accessible potentially.

Caution: It indicates a potential damage to the instrument or other property might occur.

Safety Symbols

Symbols on the Product. The following symbol may appear on the product:



Hazardous Voltage



Refer to Manual



Protective Earth Terminal



Chassis Ground



Test Ground

3. General Inspection

After you get a new multimeter, it is recommended that you should make a check on the instrument according to the following steps:

1. Check whether there is any damage caused by transportation.

If it is found that the packaging carton or the foamed plastic protection cushion has suffered serious damage, do not throw it away first till the complete device and its accessories succeed in the electrical and mechanical property tests.

2. Check the Accessories

The supplied accessories have been already described in the Appendix A: Enclosure of this Manual. You can check whether there is any loss of accessories with reference to this description. If it is found that there is any accessory lost or damaged, please get in touch with the distributor of OWON responsible for this service or the OWON's local offices.

3. Check the Complete Instrument

If it is found that there is damage to the appearance of the instrument, or the instrument can not work normally, or fails in the performance test, please get in touch with the OWON's distributor responsible for this business or the OWON's local offices. If there is damage to the instrument caused by the transportation, please keep the package. With the transportation department or the OWON's distributor responsible for this business informed about it, a repairing or replacement of the instrument will be arranged by the OWON.

4. Quick Start

Front panel overview

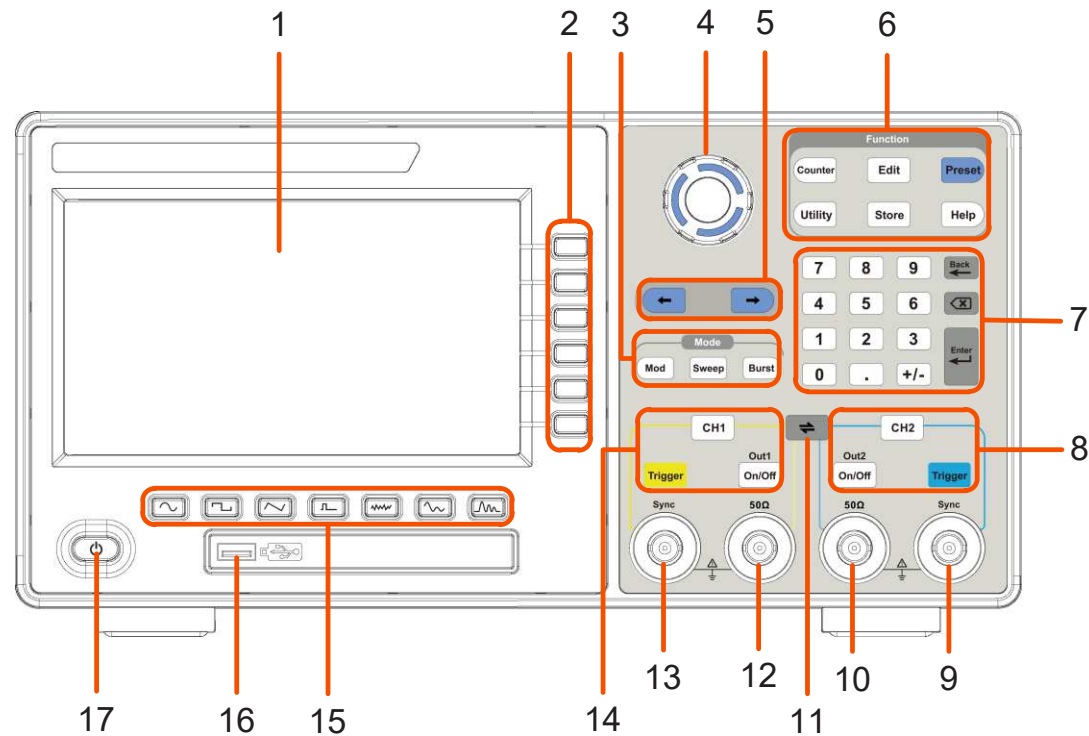









Figure 4-1 Front Panel overview

1	LCD	Display the user interface
2	Menu selection keys	Includes 6 keys to activate the corresponding menu
3	Mode keys	Mod: output the modulated waveform Sweep: scan the sine, square, ramp or arbitrary waveforms Burst: generate the sine, square, ramp, pulse or arbitrary burst
4	Knob	Change the currently selected value, also used to select the character in the soft keyboard when the file location or file name is entered. When inserting a USB flash drive, press the knob to save the current display screen to the folder of the USB flash drive in BMP image format.
5	Direction key	Move the cursor of the selected parameter

6	Operation keys	Counter: enter the counter interface
		Edit: enter the waveform edit interface
		Preset: enter the preset menu, set the reset parameter or power-on parameter; save or load the setting file.
		Utility: set the utility function
		Store: save/load arbitrary waveform or instrument setup
		Help: To get contextual help for any front panel button or menu softkey, press the button and then press the button for which you need help.
7	Number keypad	Input the parameter
8	CH2 Function keys	CH2 button: After entering the waveform interface and selecting the CH2 channel (the backlight of the button is on), the waveform and parameters of CH2 can be set after selection.
		Blue Trigger button: CH2 manual trigger button. In sweep or burst mode, when the trigger source is selected as “Manual”, each press of this button will initiate a trigger.
		On/Off button: Turns the output of the CH2 channel on or off. When the output is turned on, the backlight of the button lights up.
9	CH2 Sync	When Utility → CH1/2 Set → CH2 Sync turned on, this terminal outputs a synchronization message that matches the current configuration of CH2.
10	CH2 Out	Output CH2 signal
11	CH1⇌CH2 button	Display the channel copy menu
12	CH1 Out	Output CH1 signal
13	CH1 Sync	When Utility → CH1/2 Set → CH1 Sync turned on, this terminal outputs a synchronization message that matches the current configuration of CH1.
14	CH1 Function keys	CH1 button: After entering the waveform interface and selecting the CH1 channel (the backlight of the button is on), the waveform and parameters of CH1 can be set after selection.

Yellow Trigger button: CH1 manual trigger button. In sweep or burst mode, when the trigger source is selected as “Manual”, each press of this button will initiate a trigger.

On/Off button: Turns the output of the CH1 channel on or off. When the output is turned on, the backlight of the button lights up.

15 **Waveform Selection area** Includes: Sine , Square , Ramp , Pulse , Noise , Arb Wave , Harmonic Wave . When a waveform is selected, the corresponding backlight is lit.

16 **USB interface** Connect with external USB devices, e.g. U disk.

17 **Power button** Turn on/off the waveform generator.

Rear Panel Overview

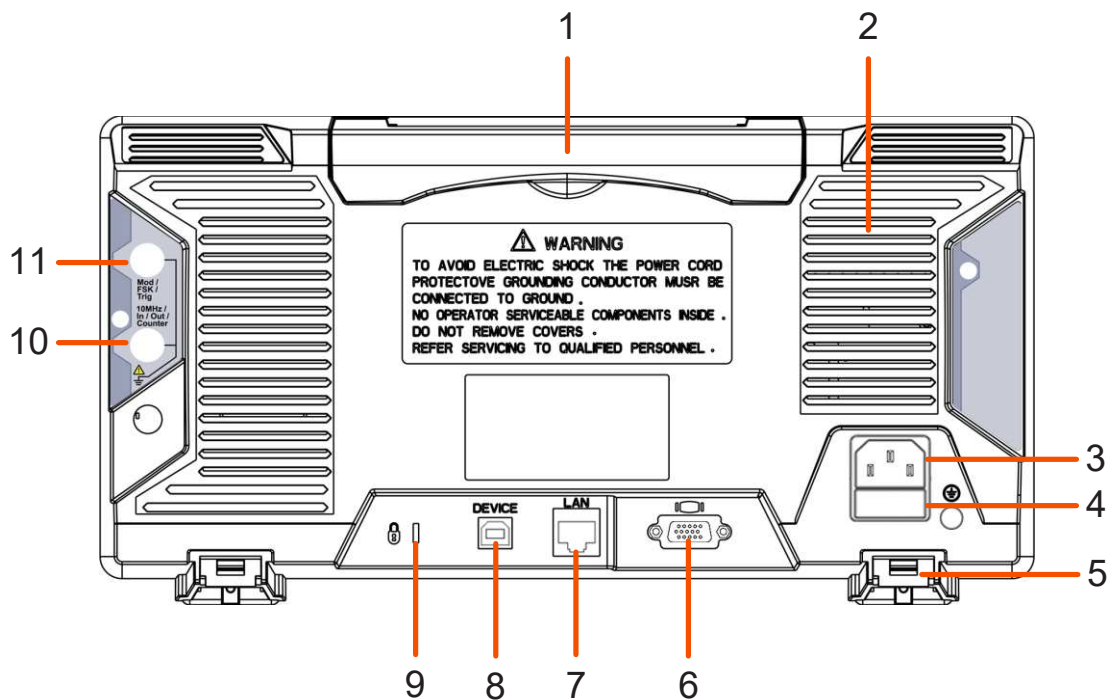

Figure 4-2 Rear Panel Overview

1 **Retractable handle**

2 **Air vents**

3 **AC input connector** AC input connector

4 **Fuse Container** The place to install the fuse

5	Foot Stool	Tilt the signal generator for easy operation.
6	COM interface (optional)	This interface can be used to connect with PC.
7	LAN interface	The network port which can be used to connect with PC.
8	USB Device interface	Used to connect a USB type B controller. Can be connected with PC, the signal generator can be controlled by the host computer software.
9	Lock Hole	You can lock the device to a fixed location using the security lock (please buy it yourself) to secure the device.
10	10MHz/In/Out/Counter (refer to clock input/output/counter input) connector	It is default to receive the frequency meter input signal. Used to receive a 10MHz clock signal when the instrument is set to an internal clock source and Utility → System → CLK Output is turned on; it is used to receive an external 10MHz clock signal when the instrument is set to an external clock source.
11	Mod/FSK/Trig (modulation/trigger input) connector	When modulating the waveform, outputting the sweep frequency, and outputting the burst, the signal accessed here can be used as an external source. Note: If one channel turns on AM, FM, PM, PWM or OSK, and the other channel turns on ASK, FSK, PSK, sweep or burst, and both channels are set to external trigger, then the channel that sets the trigger source can be accessed to external trigger, the other channel automatically cancels the external trigger because of the different external modulation signal types.

Power on

- (1) Connect the instrument to an AC power source using the power cord supplied with the accessory.



Warning:

To prevent electric shock, make sure the instrument is properly grounded.

(2) Press the **power button** on the front panel. The startup screen will display.

User Interface

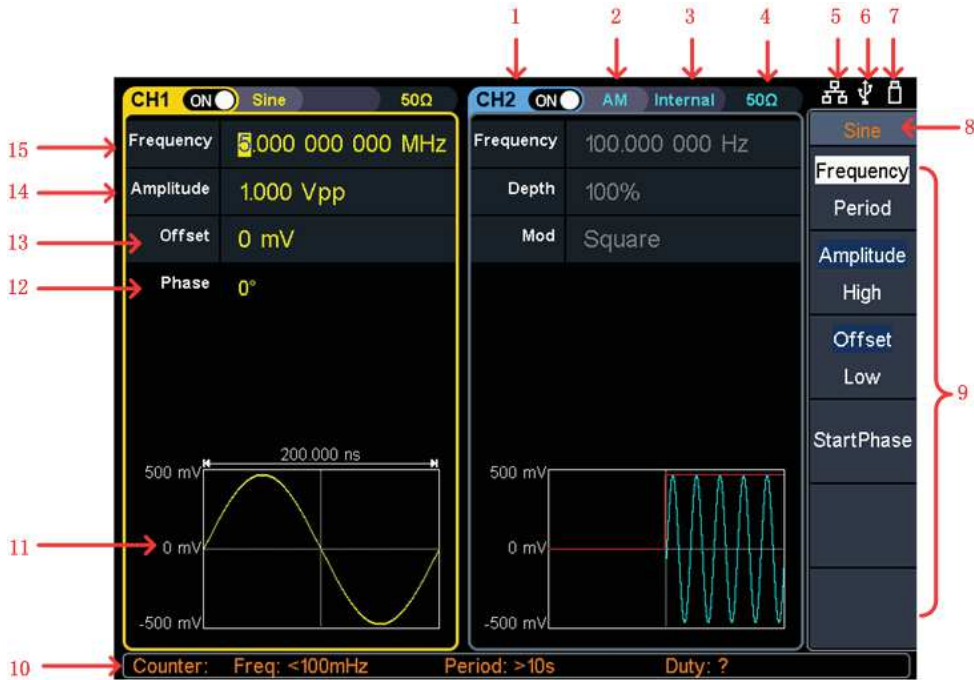

Figure 4-3 User Interface

- | | |
|----|---|
| 1 | Display channel name and channel switch status |
| 2 | Current waveform or current mode |
| 3 | Trigger source
Internal: Internal modulation or internal trigger source
External: External modulation or external trigger source
Manual: Manual trigger source |
| 4 | Load, High Z indicates high resistance |
| 5 | This indicator is lit when the network is connected through the LAN interface. |
| 6 | Lights up the indicator when connected to the USB Host via the USB DEVICE interface. |
| 7 | When the instrument detects the USB flash drive, it lights up the indicator. |
| 8 | Current menu name |
| 9 | Current waveform or mode setting menu |
| 10 | Counter brief information showing frequency value, period value |
| 11 | Display current waveform |

12	Start phase
13	Offset / low level, depending on the right highlighted menu item
14	Amplitude / high level, depending on the right highlighted menu
15	Frequency/cycle, depending on the highlighted menu item on the right

Use build-in Help

- (1) To get help on any front panel button or menu softkey, first press the front panel **Help** function button, then press the button you need help with.
- (2) Press the **Help** function key again to exit the help interface.

Set the channel

- **Select the channel for configuration**

Before configuring waveform parameters, you must first select the channel you want to configure. Press **CH1** or **CH2** to select the corresponding channel, and the corresponding channel area in the user interface will light up.







- **Turn on/off channel output**

Press CH1 **On/Off** or CH2 **On/Off** on the front panel to turn on/off the corresponding channel output. The channel will light up when it is set to output.

- **Channel copy**

- (1) Press the front panel **CH1⇌CH2** button to display the channel copy menu.
- (2) Select **CH2 To_CH1** or **CH1 To_CH2** to copy the channel.

Set basic waveform

Can set and output the Sine, Square, Ramp, Pulse, Noise, Arbitrary or Harmonic waveform. Press the waveform selection button on the front panel of the instrument: sine , square , ramp , pulse , noise , arbitrary , harmonic , and enter the corresponding waveform setting interface. The waveform is different and the parameters that can be set are different.

Example: Press the  key and press the **Frequency/Period** soft key. The selected menu item is highlighted on white, and the cursor will display on

corresponding parameter item in the user interface. Press the **Frequency/Period** softkey to switch the frequency/period.

There are two ways to change the selected parameter value:

- Turn the **Knob** to increase or decrease the value at the cursor. Press the arrow keys to move the cursor left or right.
- Press a **number key** on the numeric keypad directly, the screen will pop out of the data input box, continue to input the desired value. Press the **←** key to delete the last digit. Press the right menu soft key to select the unit of the parameter. Press the **Cancel** softkey to cancel the current entry.

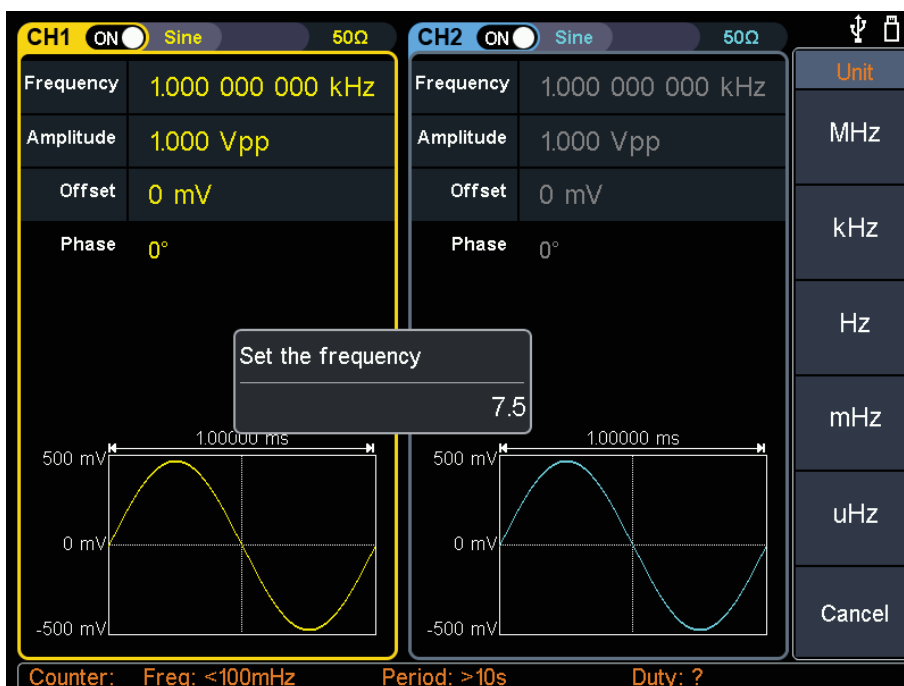



Figure 4-4: Use numeric keypad to set the frequency

Parameters of waveforms

Waveform	Menu Items
Sine	Frequency/Period, Amplitude/High, Offset/Low, StartPhase
Square	Frequency/Period, Amplitude/High, Offset/Low, StartPhase
Ramp	Frequency/Period, Amplitude/High, Offset/Low, StartPhase, Symmetry
Pulse	Frequency/Period, Amplitude/High, Offset/Low, StartPhase, Width/DutyCyc, Rising/Falling
Noise	Amplitude/High, Offset/Low
Arbitrary	Frequency/Period, Amplitude/High, Offset/Low, StartPhase, Bult-in
Harmonic	Frequency/Period, Amplitude/High, Offset/Low, StartPhase, Type, Order, SN, Amplitude, Phase

Output the build-in waveform (including DC)

- (1) Press the  arbitrary wave button to enter the arbitrary wave menu and configure the waveform parameters.
- (2) Press the **Built-in** softkey, the build-in waveform type menu will show.
- (3) Press the **Common**, **Medical treatment**, **Standard**, **Maths**, **Trigonometric**, **Window function**, **Engineering**, **Seg Mod** softkeys to enter a detailed list of categories.
- (4) Rotate the **knob** and select the file in the list, and press the **OK** softkey.

Note: DC is a type of built-in waveform, located in the "Common" category, named "DC".

Edit the arbitrary waveform

Press the **Edit** on front panel to enter the arbitrary edit interface.

- (1) **Set the wave points:** Press the **Points** softkey, turn the **knob** to adjust the value, or use the numeric keypad and press unit softkey. Range between 2 to 100,000.
- (2) **Select the template:**
Press the **Basic Template** softkey to select Blank, Sine wave, Square wave, Ramp wave, and Noise.
Press the **Arb Template** softkey to select a built-in waveform as template.
- (3) **Edit the wave points:** Press **Edit Points** to enter the wave points menu.
 - Select **Points**, input the number of point to be edited.
 - Select **Voltage**, input the voltage of the point.
 - Repeat this step to set all the points.
 - Press **Write** to enter the file system interface.

If you want to save the waveform to the internal memory, select INTER and press **Enter** softkey. Turn the knob to select one of the USER files (EditMemory cannot be selected) and press the **Save** softkey. (The file size is displayed on the right side of the USER file. If 0B is displayed, it means the file is empty.)

Description: EditMemory is a temporary data space created, saved, edited or recalled by any arbitrary wave. Saving the waveform is to save the data of this space to the user-specified location (EditMemory is in the memory and never empty). The data in this space is changed

after an arbitrary waveform is called, a new waveform is created, or a related programming command is received.

- If you want to save to a USB storage device, you need to plug the USB storage device into the front panel USB port. Turn the knob to select USBDEVICE. Press the **Enter** softkey and the instrument will list the directories of the folders and files in the USB storage device. You can turn the knob to select a folder or file. Press the **Enter** softkey to enter the currently selected folder. To return to the parent directory, press the **Back** softkey. After selecting the storage path, press the **SaveAs** softkey and the input keyboard appears on the screen. Turn the knob to select a character. Press the **ABC/abc** softkey to toggle the case of keyboard characters. Press the **Select** softkey to enter the current character. Press the **Delete** softkey to delete the last character that has been entered. Press the **Done** softkey to finish editing and the waveform will be saved in the bin file format under the current path.

Generate the Modulated Waveform

Supported modulation types include: AM (Amplitude Modulation), FM (Frequency Modulation), PM (Phase Modulation), PWM (Pulse Width Modulation), ASK (Amplitude Shift Keying), PSK (Phase Shift Keying), FSK (Frequency Shift Keying), 3FSK (ternary frequency shift keying), 4FSK (quadrature frequency shift keying), BPSK (biphase phase shift keying), QPSK (quadri phase shift keying), OSK (oscillating keying), SUM (Sum Modulation), DSB_AM (Double-Sideband Amplitude Modulation).

Press the **Mod** function key, press the **Type** softkey, turn the knob to select the modulation type, and press the **OK** softkey to enter the setup menu. To turn off the modulation, press the **Mod** function button again.

Parameters of modulated waveforms:

Type	Parameters	
AM	Internal source	Shape, AM Frequency, Depth
	External source	None
FM	Internal source	Shape, FM Frequency, Deviation
	External source	Deviation
PM	Internal source	Shape, PM Frequency, Phase Deviation
	External source	Phase Deviation
PWM	Internal source	Shape, PWM Frequency, Duty Deviation
	External source	Duty Deviation

ASK	Internal source	ASK Rate, Amplitude
	External source	Slope, Amplitude
PSK	Internal source	PSK Rate, Phase Deviation
	External source	Slope, Phase Deviation
FSK	Internal source	FSK Rate, Hop Frequency
	External source	Slope, Hop Frequency
3FSK	FSK Rate, Hop Frequency 1, Hop Frequency 2	
4FSK	FSK Rate, Hop Frequency 1, Hop Frequency 2, Hop Frequency 3	
BPSK	Bit Rate, Phase Deviation, Data Source	
QPSK	Rate,Phase1, Phase2, Phase3	
OSK	Internal source	OSK Rate, Oscillating Time
SUM	Internal source	Shape, AM Frequency, Depth
	External source	None
DSB_	Internal source	Shape, AM Frequency
AM	External source	None

Generate Sweep

In the frequency sweep mode, the generator "steps" from the start frequency to the stop frequency at the sweep rate you specify. Sweep can be generated by Sine, Square, Ramp or Arbitrary waveforms.

When the output signal is Sine, Square, Ramp or Arbitrary waveform, press the front panel **Sweep** key to enter the sweep mode (the backlight of the button lights up). The parameters allowed to be set are: Sweep Time, Linear/Log, Start Frequency/Center Frequency, Stop Frequency/Frequency Span, Trigger Source.

Generate Burst

Press the **Burst** key on the front panel to generate versatile waveforms in burst. Burst can last for certain times of waveform cycle (N-Cycle Burst), or to be controlled by external gated signals (Gated Burst). Bust can apply to Sine, Square, Ramp, Pulse and Arbitrary waveforms (Noise can not be used).

Parameters as Burst Period, Cycles/Infinite and Trigger source are allowed to be set in N-Cycle mode.

Polarity is available in Gated mode.

Counter

The frequency counter measures signals in the frequency range from 100 mHz to 200 MHz. The **[10MHz In/Out/Counter]** connector on the rear panel is used by default to receive the frequency counter input signal. The frequency meter works from the start, unless the connector is set to an external clock input or clock output.

- (1) Press the front panel **Counter** function key to enter the frequency counter interface.
- (2) Connect the signal to be tested to the **[10MHz In/Out/Counter]** connector on the rear panel.
- (3) Set the frequency counter:
 - Press the **Coupling** softkey to switch between AC and DC, to set the coupling mode of the input signal.
 - Press the **Sensitivity** softkey to toggle between Low, Middle or High. For small amplitude signals, the sensitivity is selected to be middle or high. For low frequency large signals or signals with slow rising edges, low sensitivity is selected and the measurement results are more accurate.
 - Press the **HFR** softkey to toggle On or Off high frequency rejection. High-frequency rejection can be used to filter high-frequency factors when measuring low-frequency signals, improving measurement accuracy. When measuring low frequency signals with a frequency less than 1 kHz, turn on high frequency rejection to filter out high frequency noise interference; turn off high frequency rejection when measuring high frequency signals with frequencies greater than 1 kHz.
 - Press the **Trigger Level** softkey. Turn the **knob** to change the current cursor position value, press the arrow keys to move the cursor left or right; or use the **numeric keypad** to enter a value and then select the desired unit from the right menu. The trigger level ranges from -2.5 V to 2.5 V.

After the setting is completed, the frequency counter will measure the signal to be tested at the current setting. If the reading is unstable, repeat the above adjustment until the display is stable.

- (4) The frequency, period, duty cycle, positive pulse width, and negative pulse width can be viewed on the frequency meter interface. If it is not currently in frequency counter interface, the frequency, period and duty cycle can be

viewed in the frequency counter bar at the bottom of the screen.

File Store System

The storage location is divided into the internal storage (INTER) and the USB device storage (USBDEVICE). When a USB device is connected, the main interface will show "USBDEVICE" and "INTER". Otherwise, the main interface will show "INTER" only.

The internal memory can store 32 arbitrary waveform data.

Press the front panel **Store** function key to enter the file system.

Save the current arbitrary wave

- (1) Press the  Arbitrary Wave button to enter the Arbitrary Wave menu and configure the waveform parameters.
- (2) Press the front panel **Store** function key to enter the file system.
 - If you want to save the current arbitrary waveform to the internal memory, select **INTER** and press the **Arb file** softkey. Turn the knob to select one of the USER files (EditMemory cannot be selected) and press the **Save** softkey. (The file size is displayed on the right side of the USER file. If 0B is displayed, it means the file is empty.)

Description: EditMemory is a temporary data space created, saved, edited or recalled by any arbitrary wave. Saving the waveform is to save the data of this space to the user-specified location (EditMemory is in the memory and never empty). The data in this space is changed after an arbitrary waveform is called, a new waveform is created, or a related programming command is received.

- If you want to save to a USB storage device, you need to plug the USB storage device into the front panel USB interface. Turn the knob to select **USBDEVICE**. Press the **Arb file** softkey and the instrument will list the directories of the folders and files in the USB storage device. You can turn the knob to select a folder or file. Press the **Enter** softkey to enter the currently selected folder. To return to the parent directory, press the **Back** softkey. After selecting the storage path, press the **SaveAs** softkey and the input keyboard appears on the screen. Turn

the knob to select a character. Press the **ABC/abc** softkey to toggle the case of keyboard characters. Press the **Select** softkey to enter the current character. Press the **Delete** softkey to delete the last character that has been entered. Press the **Done** softkey to finish editing and the waveform will be saved in the bin file format under the current path.

Bring up arbitrary wave files in internal/external memory

Press the front panel **Store** function key to enter the file system.

- To call up the waveform file in the internal memory, select **INTER** under the memory selection interface and press the **Arb file** softkey. Turn the knob to select a file and press the **CallOut** softkey. If the reading is successful, the screen will prompt “File Read Successful”.
- **Description:** The file size is displayed on the right side of the file. If 0B is displayed, the file is empty.
- To recall the waveform file in the USB storage device, turn the knob to select **USBDEVICE** in the memory selection interface. Press the **Arb file** softkey and the instrument will list the directories of the folders and files in the USB storage device. Turn the knob to select a folder or file. Select the file with the suffix of bin and press the **CallOut** softkey. If the reading is successful, the screen will prompt “File Read Successful”.

To copy the waveform file from the USB storage device to internal memory:

- After the waveform file in the USB storage device is called up according to the previous step, press the **Back** softkey to return to the upper directory. After returning to the memory selection interface, turn the knob to select **INTER** and press the **Arb file** softkey. Turn the knob to select a **USER** file and press the **Save** softkey to copy the waveform file to the internal memory.

Description: In the arbitrary waveform interface, Shape displays the storage location or waveform name of the current arbitrary waveform. **USER** indicates the internal memory, **External** indicates the USB storage device, and if it is a built-in waveform, the built-in waveform name is displayed.

Erase waveforms from memory

To erase all waveforms from the instrument internal memory:

- (1) Press the front panel **Store** function key to enter the file system.
- (2) Select **INTER** under the memory selection interface, and then press the **Arb file** softkey.

- (3) Press the **Secure** softkey, the screen pops up, and then press the **OK** softkey to erase all waveforms stored in internal memory.

Save/recall instrument setup

The instrument settings can be saved as files in internal memory. Up to 16 instrument settings can be saved in the instrument internal memory. The saved settings can be restored from files in the internal memory.

Operation Step:

Press the front panel **Store** function key to enter the file system.

- If you want to save the settings to the internal memory, select **INTER** and press the **Set File** softkey. Turn the knob to select a Setup file and press the **Save** softkey. (The file size is displayed on the right side of the Setup file. If 0B is displayed, it means the file is empty.)
- Note: Press the **Secure** softkey, and then press the **OK** softkey to clear all the settings in the internal memory.
- To recall a setup, select the desired setup, and press the **CallOut** softkey.

Utility Setting

Press the front panel **Utility** function key to enter the system options menu. The user can set the display parameters of the signal generator, CH1/2 parameters, interface parameters and system parameters. Press **Utility** again to exit the system options menu.

Utility system menu

Menu	Description
Display Setting	
Backlight	Set the parameter value of the screen brightness
Screen saver	Screen saver time range between 1 to 999 minutes
Separator	Set the separator for the screen display data
Date	Set the current date and time of the system
CH1/2 Setting	
CH1 Sync	Enable/disable front panel CH1 sync output terminal to output sync signal
CH2 Sync	Enable/disable front panel CH2 sync output terminal to output sync signal
CH1 Load	It is convenient for the user to match the display voltage with the desired load.

4.Quick Start

CH2 Load	The range is from 1 Ω to 10 k Ω
I/O Setting	
USB Device	<p>Set the communication protocol type of the USB Device interface on the rear panel.</p> <p>PC: This is the internal communication protocol. Select this option when connecting to the Waveform Editor software running on computer via the USB Device interface.</p> <p>USBTMC: Select this when you need to use the USBTMC communication protocol standard.</p>
Network	Network parameters while communicating with a computer using a LAN interface
System Setting	
Language	Select instrument interface language
Beeper	If On, it makes sounds when prompted
CLK Ref	Internal or External
CLK Output	When the instrument is set to the internal clock reference, it can be switched On or Off. When the selection is On, the rear panel [10MHz In/Out/Counter] connector outputs a 10MHz clock signal.
Update Firmware	The instrument firmware can be updated using a USB storage device through the front panel USB interface.

5. Communicate with PC

Supports communication with a computer via a USB port or a LAN port. Using the Waveform Editor software installed on the computer, the signal generator can be operated on the computer to control the output of the signal generator.

Here's how to connect to a computer. First, install the Waveform Editor software on the CD-ROM on your computer. Then, there are several connection options to choose from.

Using USB Port

- (1) **Set the USB device protocol type of the signal generator:** Press **Utility** → **I/O Setup** → **USBDEV**, switch to PC.
- (2) **Connection:** Connect the USB Device interface on the rear panel of the signal generator to the **USB interface** of the computer with a USB cable.
- (3) **Install the driver:** Run Waveform Editor software on the computer, press F1 to view the built-in help documentation. Follow the instructions to install the driver. The path of the driver is the USBDRV folder in the directory where the Waveform Editor communication software is located, such as "C:\Program Files (x86)\DS_Wave\Waveform Editor\USBDRV".
- (4) **Host computer communication port setting:** Open the Waveform Editor software, click "Communications" in the menu bar, select "Ports-Settings", in the setting dialog box, select the communication port as "USB". After the connection is successful, the connection status prompt in the lower right corner of the software interface turns green.

Using LAN Port

Connect Directly

- (1) **Connection.** Plug one end of the network cable into the LAN connector on the rear panel of the signal generator; the other end is plugged into the LAN interface of the computer.
- (2) **Set the network parameters of the computer.** Since the signal generator does not support automatic IP address acquisition, you need to specify the IP yourself. Here we set the IP address to 192.168.1.71.
- (3) **Set the network parameters of the host computer.** Run Waveform Editor software on the computer. In the "Communications" menu, under "Ports-Settings", select the communication port as "LAN", the IP is set to be the same as the first three fields of the computer's network IP in step (2), and the

last field has a different IP address. It is "192.168.1.99"; the port can be set to any value from 0 to 4000. However, since ports below 2000 are often occupied, it is recommended to set it to 2000 or higher. Here, it is set to "3000".

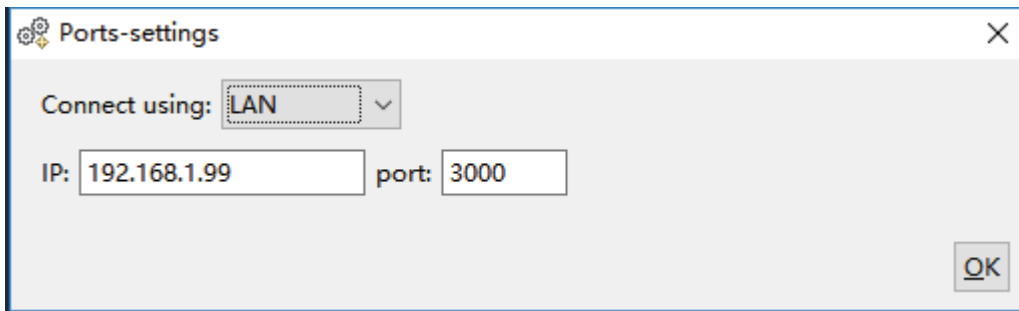

Figure 5-1: Setting the network parameters of the host computer

- (4) **Set the network parameters of the signal generator.** In the signal generator, press **Utility** → **I/O Setup** → **Network setting** to enter the submenu. Set the IP address and port to the IP and port in the PC software port settings in step (3). After the shutdown and restart, if the data can be obtained normally in the PC software, the connection is successful.

Connect through a Router

- (1) **Connection.** Connect the LAN interface on the rear panel of the signal generator to the router with a network cable. The computer is also connected to the router.
- (2) **Set the network parameters of the computer.** Since the signal generator does not support automatic IP address acquisition, you need to specify the IP yourself. The default gateway and subnet mask settings must match the settings of the router. For example, the IP address is set to 192.168.1.71, the subnet mask is set to 255.255.255.0, and the default gateway is set to 192.168.1.1.
- (3) **Set the network parameters of the host computer.** Run Waveform Editor software on the computer. In the "Communications" menu, under "Ports-Settings", select the communication port as "LAN", the IP is set to be the same as the first three fields of the computer's network IP in step (2), and the last field has a different IP address. It is "192.168.1.99"; the port can be set to any value from 0 to 4000. However, since ports below 2000 are often occupied, it is recommended to set it to 2000 or higher. Here, it is set to "3000".

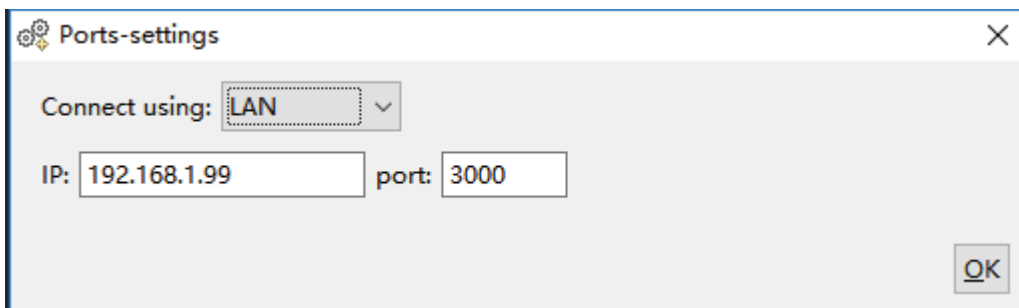

Figure 5-1: Set the network parameters of the host computer

- (4) **Set the network parameters of the signal generator.** In the signal generator, press **Utility** → **I/O Setup** → **Network setting** to enter the submenu. Set the IP address and port to the IP and port in the PC software port settings in step (3). The gateway settings need to be the same as the gateway settings of the router. After the shutdown and restart, if the data can be obtained normally in the PC software, the connection is successful.

For the specific operation method of Waveform Editor software, please press F1 to view the built-in help documentation.

6. Appendix

Appendix A: Accessories

- 1 × power cord that meets the standards of the country where you are located
- 1 × USB communication cable
- 1 × CD with communication software
- 1 × Quick Guide
- 2 × BNC/Q9 cable

Appendix B: General Care and Cleaning

General Maintenance

Do not store or leave the instrument where the liquid crystal display will be exposed to direct sunlight for long periods of time.

Caution: To avoid any damage to the instrument or probe, do not exposed it to any sprays, liquids, or solvents.

Cleaning

Inspect the instrument and probes as often as operating conditions require. To clean the instrument exterior, perform the following steps:

1. Wipe the dust from the instrument and probe surface with a soft cloth. Do not make any scuffing on the transparent LCD protection screen when clean the LCD screen.
2. Disconnect power before cleaning your instrument. Clean the instrument with a wet soft cloth not dripping water. It is recommended to scrub with soft detergent or fresh water. To avoid damage to the instrument or probe, do not use any corrosive chemical cleaning agent



Warning: Before power on again for operation, it is required to confirm that the instrument has already been dried completely, avoiding any electrical short circuit or bodily injury resulting from the moisture.



**XDG2000 Series Dual-Channel
Arbitrary Waveform Generator
User Manual**

www.owon.com

July 2020 Edition V1.1.0

Copyright © LILLIPUT Company. All rights reserved.

The LILLIPUT's products are under the protection of the patent rights, including ones which have already obtained the patent rights and those which are applied for. The information in this manual will replace all materials published.

The information in this manual was correct at the time of printing. However, LILLIPUT will continue to improve products and reserves the rights to change specification at any time without notice.

owon[®] is the registered trademark of the LILLIPUT Company.

Fujian LILLIPUT Optoelectronics Technology Co., Ltd.

No. 19, Heming Road

Lantian Industrial Zone, Zhangzhou 363005 P.R. China

Tel: +86-596-2130430

Fax: +86-596-2109272

Web: www.owon.com

E-mail: info@owon.com.cn

General Warranty

We warrant that the product will be free from defects in materials and workmanship for a period of 3 years from the date of purchase of the product by the original purchaser from our company. The warranty period for accessories such as probes, battery is 12 months. This warranty only applies to the original purchaser and is not transferable to a third party.

If the product proves defective during the warranty period, we will either repair the defective product without charge for parts and labour, or will provide a replacement in exchange for the defective product. Parts, modules and replacement products used by our company for warranty work may be new or reconditioned like new. All replaced parts, modules and products become the property of our company.

In order to obtain service under this warranty, the customer must notify our company of the defect before the expiration of the warranty period. Customer shall be responsible for packaging and shipping the defective product to the designated service centre, a copy of the customers proof of purchase is also required.

This warranty shall not apply to any defect, failure or damage caused by improper use or improper or inadequate maintenance and care. We shall not be obligated to furnish service under this warranty a) to repair damage resulting from attempts by personnel other than our company representatives to install, repair or service the product; b) to repair damage resulting from improper use or connection to incompatible equipment; c) to repair any damage or malfunction caused by the use of not our supplies; or d) to service a product that has been modified or integrated with other products when the effect of such modification or integration increases the time or difficulty of servicing the product.

Please contact the nearest Sales and Service Offices for services.

Excepting the after-sales services provided in this summary or the applicable warranty statements, we will not offer any guarantee for maintenance definitely declared or hinted, including but not limited to the implied guarantee for marketability and special-purpose acceptability. We should not take any responsibilities for any indirect, special or consequent damages.

Table of Contents

1.General Safety Requirement	1
2.Safety Terms and Symbols.....	2
3.General Inspection.....	3
4.Quick Start	4
Front Panel Overview	4
Rear Panel Overview	6
Foot Stool Adjustment	7
Power On.....	7
User Interface.....	8
Touchscreen Controls (Touchscreen is optional)	9
Operate the Menu through Touchscreen.....	9
Touch screen operation	9
5.Panel Operation	13
Channel Setting	13
Select the channel for configuration	13
Turn on/off channel output.....	13
Inter-channel.....	13
Waveform Setting.....	14
Output Sine Wave	14
Set the frequency/period.....	15
Set the amplitude.....	16
Set the offset.....	16
Set the high level.....	16
Set the low level.....	17
Set the start phase	17
Output Square Wave	17
Output Ramp Wave	17
Set the symmetry	18
Output Pulse Wave.....	19
Set the pulse width/duty cycle.....	19
Set the rising/falling time.....	22
Output Noise Wave	22
Output Arbitrary Wave.....	22
Select build-in wave (including DC).....	23
Output Harmonic Wave.....	28
Harmonic wave function overview	28
Set the Fundamental Wave Parameters.....	29

Select the harmonic type	29
Set the harmonic order	29
Set the harmonic amplitude of each order	30
Set the harmonic phase of each order	30
Output the Modulated Waves.....	30
AM (Amplitude Modulation).....	31
DSB-AM (Double-Sideband AM)	32
FM (Frequency Modulation)	33
PM (Phase Modulation)	35
PWM (Pulse Width Modulation).....	36
ASK (Amplitude Shift Keying)	37
FSK (Frequency Shift Keying).....	39
PSK (Phase Shift Keying).....	40
3FSK (3 Frequency Shift Keying)	41
4FSK (4 Frequency Shift Keying)	43
BPSK (Binary Phase Shift Keying).....	44
QPSK (Quadrature Phase Shift Keying).....	45
OSK (Oscillation Shift Keying).....	46
SUM (Sum Modulation).....	47
Generate Sweep (Sweep)	49
Generate Burst (Burst)	50
Set N-Cycle Burst.....	51
Set Gated Burst	52
Counter	54
Utility Function Setting	54
Display Settings	55
Brightness Control.....	55
Screen Saver	55
Separator.....	55
Date	55
Contrast.....	56
CH1/2 Settings.....	56
Sync	56
Load.....	57
I/O Setup	57
USB Device Type.....	57
Network Setting	58
System Settings	58
Language	58
Beeper	58
Clock Source.....	59
Clock Output.....	59
Firmware Update	59
Edit the Arbitrary Wave (Edit).....	60

File Store System (Store).....	61
Save the current arbitrary wave.....	61
Bring up arbitrary wave files in internal/external memory.....	62
Erase waveforms from memory.....	63
Save/recall Instrument Settings.....	63
Preset Settings (Preset).....	63
Restore to the factory setting.....	63
Restore to the user setting.....	67
Power-on setting.....	68
Use Build-in Help (Help).....	68
6.Communicate with PC.....	69
Using USB Port.....	69
Using LAN Port.....	69
Connect Directly.....	69
Connect through a Router.....	70
7.Troubleshooting.....	72
8.Specification.....	73
Waveforms.....	73
Frequency Characteristics.....	73
Amplitude Characteristics.....	74
Signal Characteristics.....	74
Modulation Characteristics.....	76
Sweep Characteristics.....	78
Burst Characteristics.....	79
Counter Specifications.....	79
Input/Output Characteristics.....	79
General Specifications.....	80
9.Appendix.....	81
Appendix A: Accessories.....	81
Appendix B: General Care and Cleaning.....	81

1. General Safety Requirement

Before any operations, please read the following safety precautions to avoid any possible bodily injury and prevent this product or any other products connected from damage. In order to avoid any contingent danger, this product is only used within the range specified.

Only the qualified technicians can implement the maintenance.

To avoid Fire or Personal Injury:

Use Proper Power Cord. Use only the power cord supplied with the product and certified to use in your country.

Product Grounded. This instrument is grounded through the power cord grounding conductor. To avoid electric shock, the grounding conductor must be grounded. The product must be grounded properly before any connection with its input or output terminal.

Limit operation to the specified measurement category, voltage, or amperage ratings.

Check all Terminal Ratings. To avoid fire or shock hazard, check all ratings and markers on the instrument. Refer to the user's manual for more information about ratings before connecting the instrument. Do not exceed any of ratings defined in the following section.

Do not operate without covers. Do not operate the instrument with covers or panels removed.

Use Proper Fuse. Use only the specified type and rating fuse for this instrument.

Avoid exposed circuit. Do not touch exposed junctions and components when the instrument is powered.

Do not operate if in any doubt. If you suspect damage occurs to the instrument, have it inspected by qualified service personnel before further operations.

Use your instrument in a well-ventilated area. Inadequate ventilation may cause an increasing of temperature or damages to the instrument. Please keep the instrument well ventilated, and inspect the air outlet and the fan regularly.

Do not operate in wet conditions. To avoid short circuit inside the instrument or electric shock, never operate the instrument in a humid environment.

Do not operate in an explosive atmosphere.

Keep instrument surfaces clean and dry.

2. Safety Terms and Symbols

Safety Terms

Terms in this Manual. The following terms may appear in this manual:



Warning: Warning indicates the conditions or practices that could result in injury or loss of life.



Caution: Caution indicates the conditions or practices that could result in damage to this product or other property.

Terms on the Product. The following terms may appear on this product:

Danger: It indicates an injury or hazard may immediately happen.

Warning: It indicates an injury or hazard may be accessible potentially.

Caution: It indicates a potential damage to the instrument or other property might occur.

Safety Symbols

Symbols on the Product. The following symbol may appear on the product:



Hazardous Voltage



Refer to Manual



Protective Earth Terminal



Chassis Ground



Test Ground

3. General Inspection

After you get a new generator, it is recommended that you should make a check on the instrument according to the following steps:

1. Check whether there is any damage caused by transportation.

If it is found that the packaging carton or the foamed plastic protection cushion has suffered serious damage, do not throw it away first till the complete device and its accessories succeed in the electrical and mechanical property tests.

2. Check the Accessories

The supplied accessories have been already described in *Appendix A: Accessories* of this manual. You can check whether there is any loss of accessories with reference to this description. If it is found that there is any accessory lost or damaged, please get in touch with our distributor responsible for this service or our local offices.

3. Check the Complete Instrument

If it is found that there is damage to the appearance of the instrument, or the instrument can not work normally, or fails in the performance test, please get in touch with our distributor responsible for this business or our local offices. If there is damage to the instrument caused by the transportation, please keep the package. With the transportation department or our distributor responsible for this business informed about it, a repairing or replacement of the instrument will be arranged by us.

4. Quick Start

Front Panel Overview

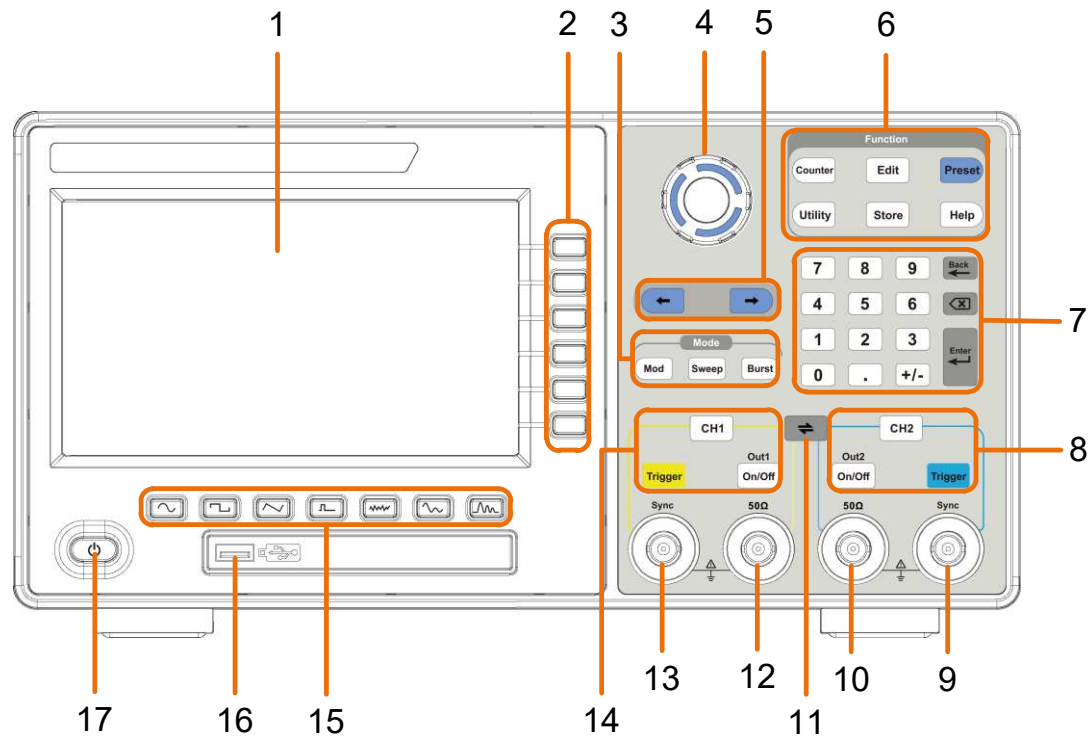









Figure 4-1: Front Panel overview

1	LCD	Display the user interface
2	Menu selection keys	Includes 6 keys to activate the corresponding menu
3	Mode keys	<p>Mod: Output the modulated waveform</p> <p>Sweep: Scan the sine, square, ramp or arbitrary waveforms</p> <p>Burst: Generate the sine, square, ramp, pulse or arbitrary burst</p>
4	Knob	<p>Change the currently selected value, also used to select the character in the soft keyboard when the file location or file name is entered.</p> <p>When inserting a USB flash drive, press the knob to save the current display screen to the folder of the USB flash drive in BMP image format.</p>
5	Direction key	Move the cursor of the selected parameter
6	Operation keys	<p>Counter: Enter the counter interface</p> <p>Edit: Enter the wavform edit interface</p> <p>Preset: Enter the preset menu, set the reset parameter or power-on parameter.</p>

4.Quick Start

	Utility: Set the utility function
	Store: Save/load arbitrary waveform or instrument setup
	Help: To get contextual help for any front panel button or menu softkey, press the button and then press the button for which you need help.
7	Number keypad Input the parameter
8	CH2 Function keys CH2 button: After entering the waveform interface and selecting the CH2 (the backlight of the button is on), the waveform and parameters of CH2 can be set after selection. Blue Trigger button: CH2 manual trigger button. In sweep or burst mode, when the trigger source is selected as “Manual”, each press of this button will initiate a trigger. On/Off button: Turns the output of the CH2 channel on or off. When the output is turned on, the backlight of the button lights up.
9	CH2 Sync When Utility → CH1/2 Set → CH2 Sync turned on, this terminal outputs a synchronization message that matches the current configuration of CH2.
10	CH2 Out Output CH2 signal
11	⇌ button Display the inter-channel menu. You can copy the parameters of one channel to the other, synchronize the frequency or amplitude, and align the phase of two channel signals.
12	CH1 Out Output CH1 signal
13	CH1 Sync When Utility → CH1/2 Set → CH1 Sync turned on, this terminal outputs a synchronization message that matches the current configuration of CH1.
14	CH1 Function keys CH1 button: After entering the waveform interface and selecting the CH1 (the backlight of the button is on), the waveform and parameters of CH1 can be set after selection. Yellow Trigger button: CH1 manual trigger button. In sweep or burst mode, when the trigger source is selected as “Manual”, each press of this button will initiate a trigger. On/Off button: Turns the output of the CH1 channel on or off. When the output is turned on, the backlight of the button lights up.
15	Waveform Selection area Includes: Sine  , Square  , Ramp  , Pulse  , Noise  , Arb Wave  , Harmonic Wave  . When a waveform is selected, the corresponding backlight is lit.

-
- | | | |
|----|----------------------|---|
| 16 | USB interface | Connect with external USB devices, e.g. U disk. |
| 17 | Power button | Turn on/off the waveform generator. |
-

Rear Panel Overview

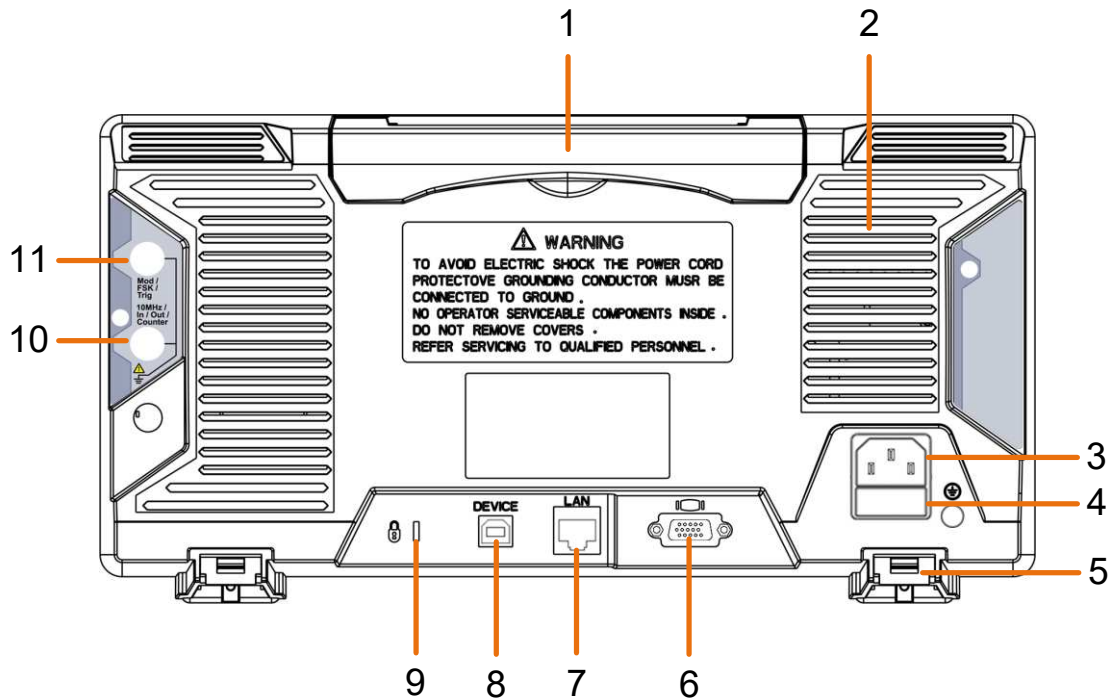

Figure 4-2: Rear Panel Overview

1	Retractable handle	
2	Air vents	
3	AC input connector	AC input connector
4	Fuse Container	The place to install the fuse
5	Foot Stool	Tilt the signal generator for easy operation.
6	COM interface (optional)	This interface can be used to connect with PC.
7	LAN interface	The network port which can be used to connect with PC.
8	USB Device interface	Used to connect a USB type B controller. Can be connected with PC, the signal generator can be controlled by the host computer software.

9 Lock Hole	You can lock the device to a fixed location using the security lock (please buy it yourself) to secure the device.
10 10MHz/In/Out/Counter (refer to clock input/output/counter input) connector	It is default to receive the frequency meter input signal. Used to output a 10MHz clock signal when the instrument is set to an internal clock source and Utility → System → CLK Output is turned on; it is used to receive an external 10MHz clock signal when the instrument is set to an external clock source.
11 Mod/FSK/Trig (modulation/trigger input) connector	<p>When modulating the waveform, outputting the sweep frequency, and outputting the burst, the signal accessed here can be used as an external source.</p> <p>Note: If one channel turns on AM, FM, PM, PWM or OSK, and the other channel turns on ASK, FSK, PSK, sweep or burst, and both channels are set to external trigger, then the channel that sets the trigger source can be accessed to external trigger, the other channel automatically cancels the external trigger because of the different external modulation signal types.</p>

Foot Stool Adjustment

Unfold the foot stools on the bottom of the generator, as **5 Foot Stool** in *Figure 4-2*.

Power On

- (1) Connect the instrument to an AC power source using the power cord supplied with the accessory.



Warning:

To prevent electric shock, make sure the instrument is properly grounded.

- (2) Press the **power button** on the front panel. The startup screen will display.

User Interface



Figure 4-3: User Interface

- | | |
|----|---|
| 1 | Display channel name and channel switch status |
| 2 | Current waveform or current mode |
| 3 | Trigger source
Internal: Internal modulation or internal trigger source
External: External modulation or external trigger source
Manual: Manual trigger source |
| 4 | Load, High Z indicates high resistance |
| 5 | This indicator is lit when the network is connected through the LAN interface. |
| 6 | Lights up the indicator when connected to the USB Host via the USB DEVICE interface. |
| 7 | When the instrument detects the USB flash drive, it lights up the indicator. |
| 8 | Current menu name |
| 9 | Current waveform or mode setting menu |
| 10 | Counter brief information showing frequency value, period value and |
| 11 | Display current waveform |
| 12 | Start phase |
| 13 | Offset / low level, depending on the right highlighted menu item |
| 14 | Amplitude / high level, depending on the right highlighted menu item |
| 15 | Frequency/cycle, depending on the highlighted menu item on the right |

Touchscreen Controls (Touchscreen is optional)

If the LCD is touchscreen, the signal generator can be controlled by touch.

The instruction of touchscreen controls is as below. You can also use the buttons / knobs enclosed in brackets to do the same thing.

Operate the Menu through Touchscreen

- **Touchable menu pane:** Click the  icon at the bottom right of the display area, a menu pane will be shown, see Figure 4-4: **Touchable menu pane**. Clicking the menu item is same as pushing the corresponding button.
- **Select or switch menu items:** Touch the menu items in the right menu, see Figure 4-4: **Touchable menu pane**. If there are options that can be switched in the menu, you can repeatedly touch the area of the menu item to switch, or push the corresponding button to switch.

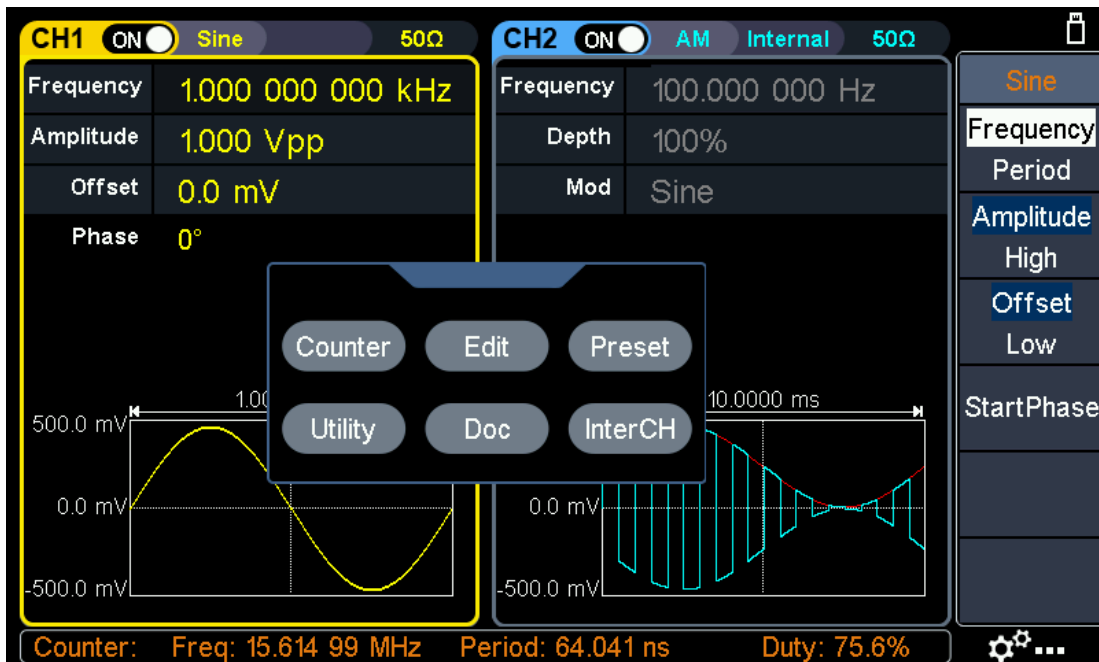

Figure 4-4: Touchable menu pane

Touch screen operation

- **Select a channel (CH1 or CH2 button):** Touch the blank area of the corresponding channel to make the channel selected.
- **Turn on or off a channel (On/Off key):** Click the ON/OFF switch at the top of the screen to turn on or off the channel.

4.Quick Start

- **Channel copy** (shortcut): Slide left or right on any channel waveform to another channel, the following dialog appears, click "OK" to complete the copy channel operation. This operation is equivalent to pressing \Leftrightarrow and selecting **CH2 To_CH1** or **CH1 To_CH2**.

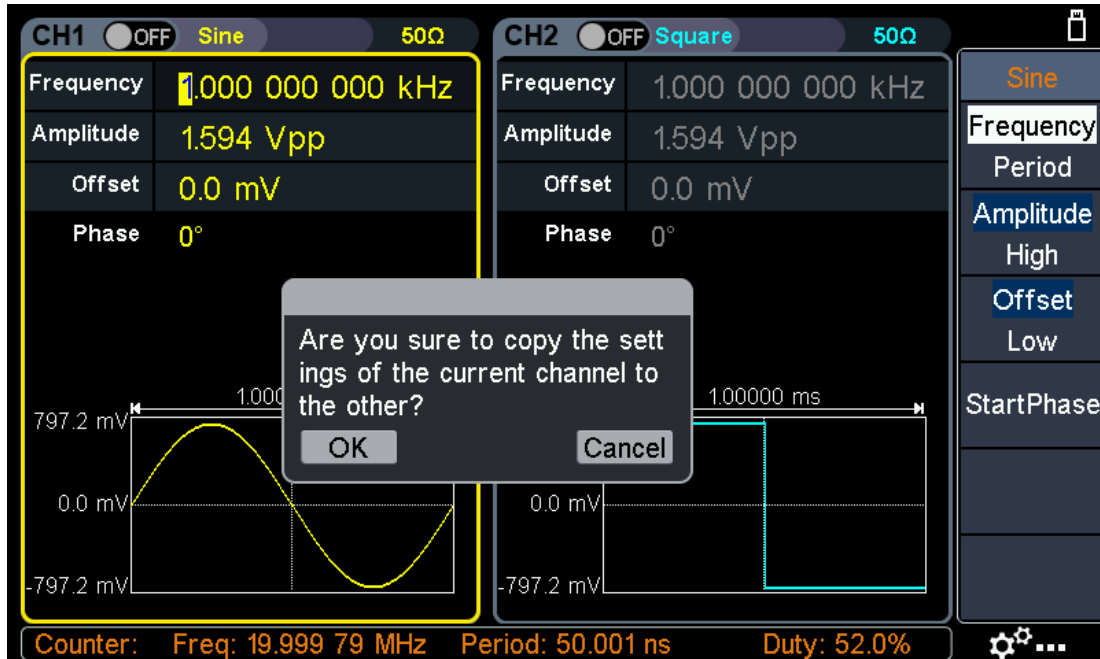

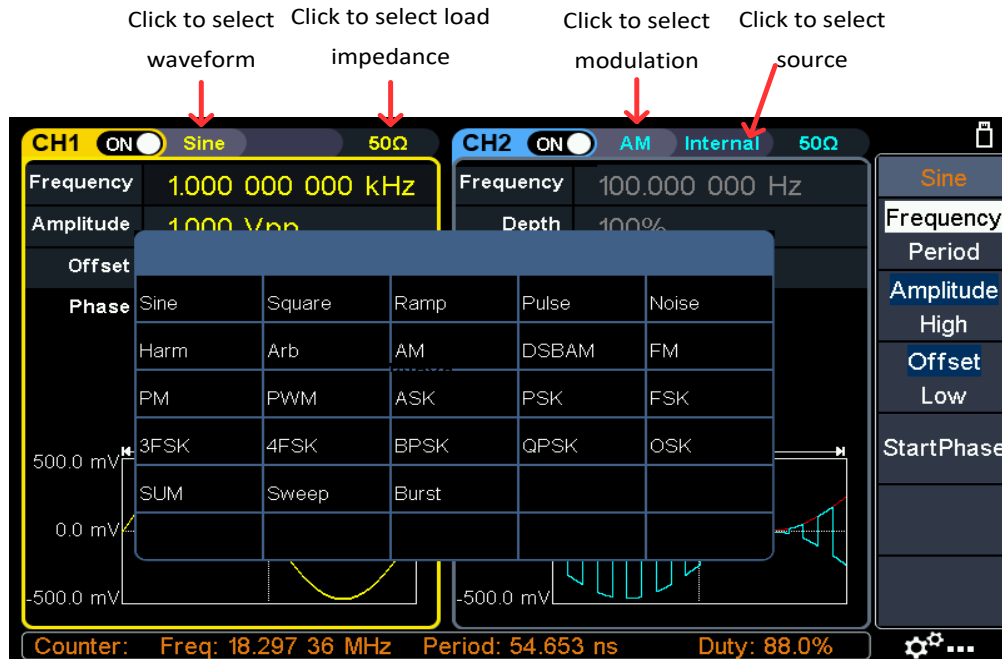

- **Select the waveform or modulation type** (the waveform keys \sim , \square , m , w , m , **Mod** on the front panel): See the figure below for details. Click the desired waveform or modulation to enter the corresponding waveform or modulation setting interface. Different waveforms or modulations have different parameters that can be set.

4.Quick Start



- **Parameter setting:** Click on the value area of the parameter to be set, the screen will pop out the setting box, input the desired value, and select the unit or symbol on the right side of the setting box, as shown in the figure below:



- **Waveform zoom:** Click the waveform display area at the bottom of the screen to enter the waveform zoom screen. As shown in the figure below, pinch and spread horizontally or vertically to change the frequency or amplitude of the channel. Click  to make the waveform fit the screen. Click  to return to the main interface, the frequency or amplitude also changes accordingly.

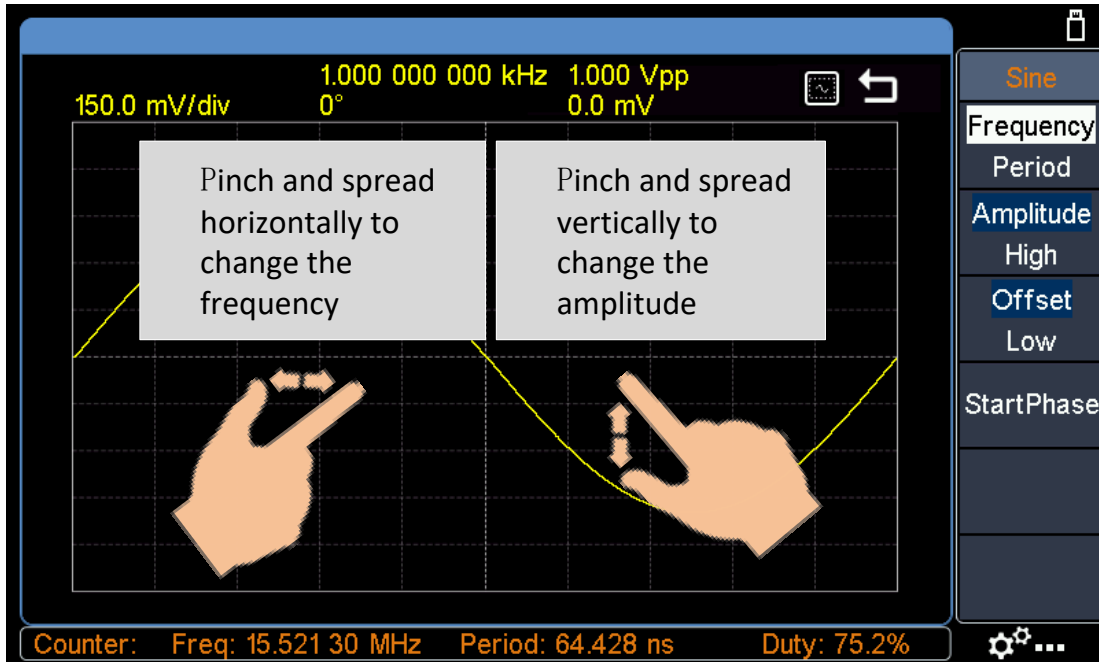



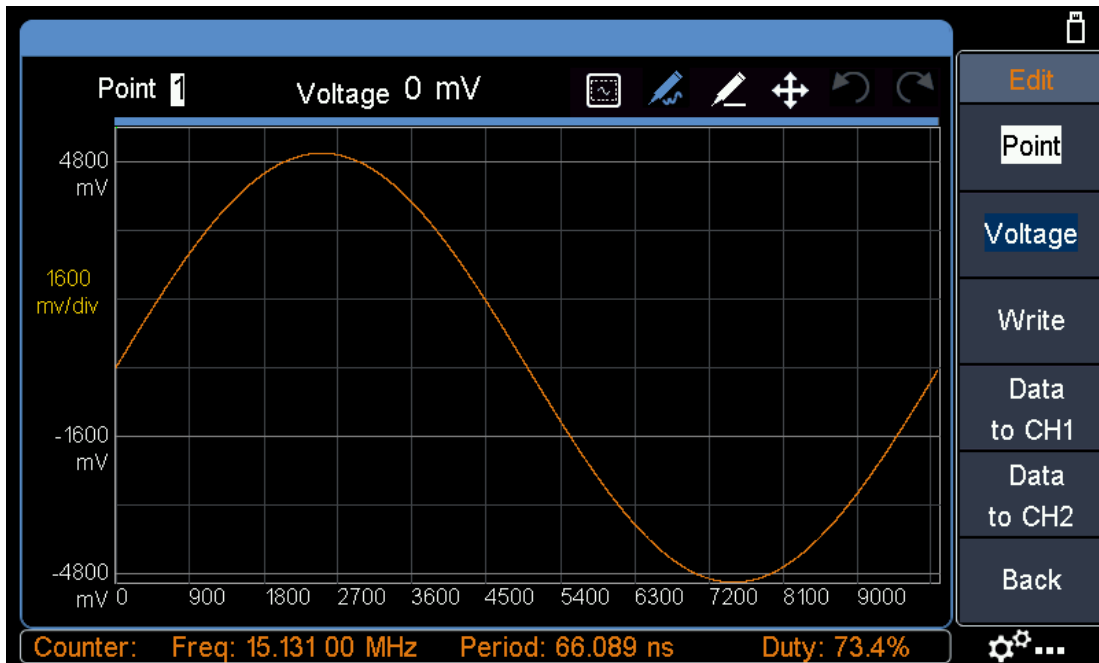



- **Edit waveform point:** Click the  icon at the bottom right of the display area, the touchable menu pane appears on the screen. Click "Waveform Edit", click "Edit Points" in the right menu, and enter the following interface. You can edit the desired point by clicking the relevant menu and icon.



Icon description

Icon	Function Description
------	----------------------

	Adaptive to the screen. After clicking this icon, the waveform can be displayed to adapt to the screen ratio.
	Edit the wave curve. Select this icon, then you can drag and draw a curve, and there can only be one point in the same X coordinate.
	Edit the waveform line. Select this icon, then you can drag to draw a straight line. The Y coordinate of the entire line is the Y coordinate of the first touch point.
	Move the graph. When the waveform display range is larger than the screen range, select this icon, then you can drag the graph, and the waveform will not change.
	Undo. You can undo the last operation (Note: only applicable to undo after waveform editing).
	Cancel undo. Used to cancel the last undo operation.

5. Panel Operation

Channel Setting

Select the channel for configuration

Before configuring waveform parameters, you must select the channel you want to configure. Press **CH1** or **CH2** to select the corresponding channel, and the corresponding channel area in the user interface will light up.

Turn on/off channel output

Press CH1 **On/Off** or CH2 **On/Off** button on the front panel to turn on/off output of the corresponding channel. The backlight of the button will be lighted when the corresponding channel is tuned on.

Inter-channel







The instrument can copy the parameters of one channel to the other. If frequency or

amplitude of both channels are synchronized, when you change the parameter of either channel, the parameter of the other channel is set to the same value.

- (1) Press  on the front panel to display the inter-channel menu.
- (2) Press **CH2 To_CH1** to copy parameters of CH2 to CH1.
- (3) Press **CH1 To_CH2** to copy parameters of CH1 to CH2.
- (4) Press **FreqSync** to toggle between **On** and **Off**. At on status, the frequency of the two channels can be adjusted synchronously.
- (5) Press **AmpSync** to toggle between **On** and **Off**. At on status, the amplitude of the two channels can be adjusted synchronously.
- (6) Press **AlignPhase** to align the phase of two channel signals.

Waveform Setting

Sine, square, ramp, pulse, noise, arbitrary or harmonic waves can be set and output.

Press the waveform selection button on the front panel: sine , square , ramp , pulse , noise , arbitrary wave , harmonic , and enter the corresponding waveform setting interface. The waveform is different and the parameters that can be set are different.

Note: The following setting waveform uses CH1 channel as an example. If you need to set CH2 channel, please refer to CH1 channel specific operation.

Output Sine Wave

Press , the screen displays the user interface of the sine wave. The Sine waveform parameters can be set by operating the Sine setting menu on the right.

The sine wave menu includes: **Frequency/Period**, **Amplitude/High Level**, **Offset/Low Level**, and **Start Phase**. The menu can be operated by the menu selection button on the right.

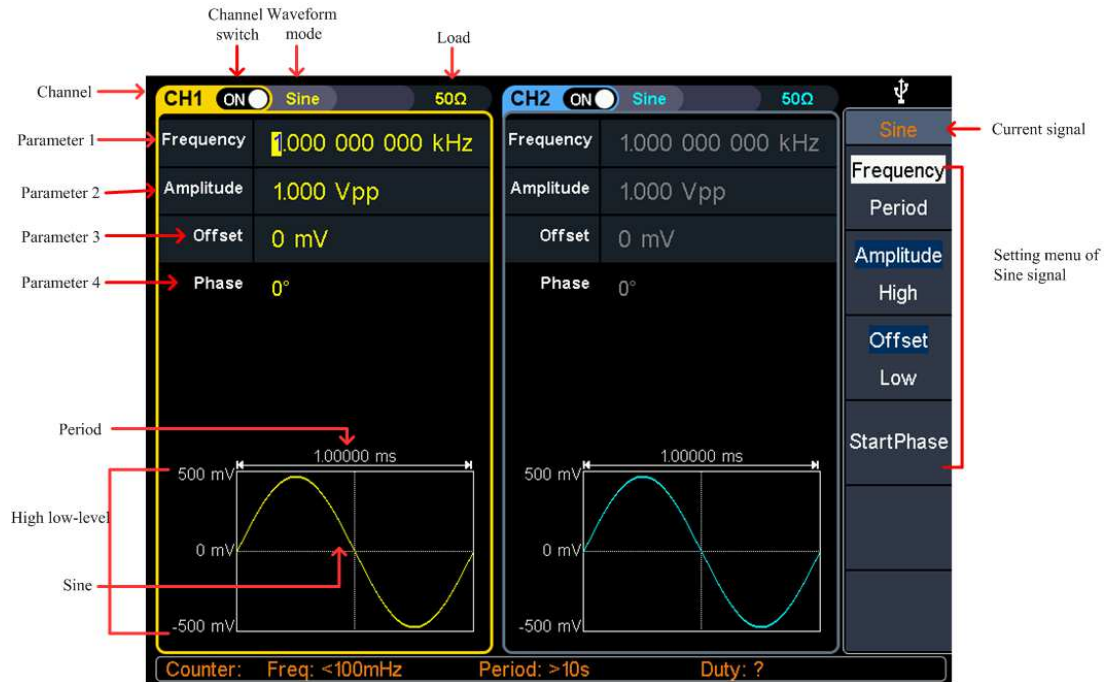

Figure 5-1: Sine wave user interface

Set the frequency/period

- Press **CH1**, all currently selected CH1 menu items are highlighted.
- Press the **Frequency/Period** softkey, the selected menu item is highlighted in white, and a cursor will display on the corresponding parameter item in **Parameter 1**. Press the **Frequency/Period** softkey to switch the frequency and period.

There are two ways to change the selected parameter value:

- Turn the **knob** to increase or decrease the value at the cursor. Press the **←/→** arrow key to move the cursor left or right.
- Press a number key on the **numeric keypad** directly, the screen will pop out the data input box, input the desired value. Press the **X** key on the **numeric keypad** to delete the last digit, press the **←** **Back** key to cancel the input, and press the **Enter** key to confirm the input in default unit. Press the **MHz**, **kHz**, **Hz**, **mHz**, **uHz** softkeys to select the unit of the parameter. Press the **Cancel** softkey to cancel the current input parameter value.

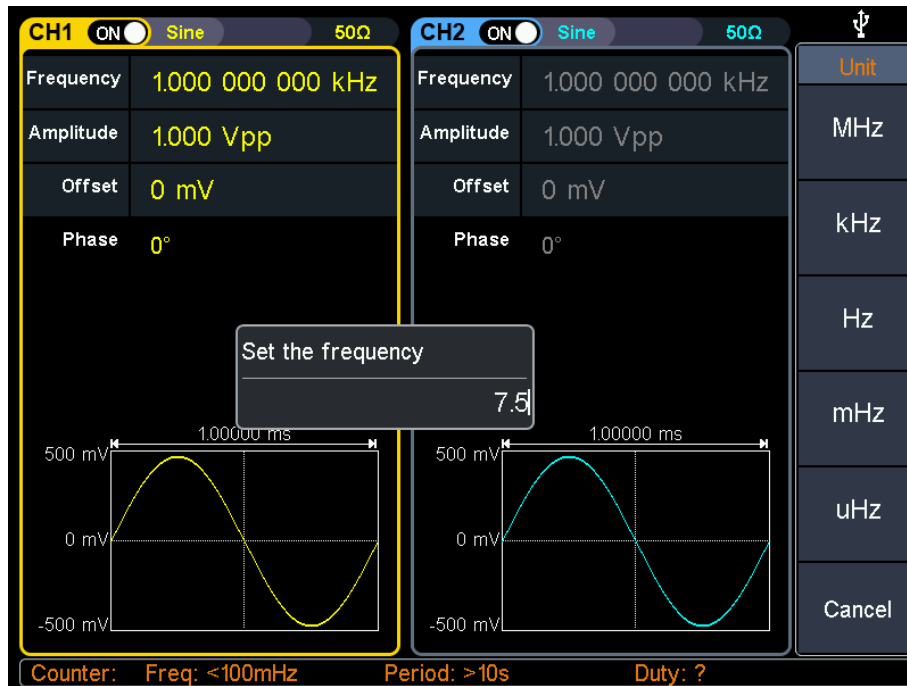

Figure 5-2: Use the numeric keypad to set the frequency

Set the amplitude

Press the **Amplitude/High** softkey to confirm whether the **Amplitude** menu item is highlighted; if not, press the **Amplitude/High** softkey to switch to **Amplitude**. In **Parameter 2** of Figure 5-1, a blinking cursor appears in the parameter value of amplitude. Turn the **knob** to change the value directly, or use the **numeric keypad** to input the desired value and choose the unit.

Set the offset

Press the **Offset/Low** softkey to confirm whether the **Offset** menu item is highlighted; if not, press the **Offset/Low** softkey to switch to **Offset**. In **Parameter 3** of Figure 5-1, a blinking cursor appears in the parameter value of offset. Turn the **knob** to change the value directly, or use the **numeric keypad** to input the desired value and choose the unit.

Set the high level

Press the **Amplitude/High** softkey to confirm whether the **High** menu item is highlighted; if not, press the **Amplitude/High** softkey to switch to **High**. In **Parameter 2** of Figure 5-1, a blinking cursor appears in the parameter value of high level. Turn the **knob** to change the value directly, or use the **numeric keypad** to input the desired value and choose the unit.

Set the low level

Press the **Offset/Low** softkey to confirm whether the **Low** menu item is highlighted; if not, press the **Offset/Low** softkey to switch to **Low**. In **Parameter 3** of Figure 5-1, a blinking cursor appears in the parameter value of low level. Turn the **knob** to change the value directly, or use the **numeric keypad** to input the desired value and choose the unit.

Set the start phase

Press the **Start Phase** softkey, the **Start Phase** menu item is highlighted. In **Parameter 4** of Figure 5-1, a blinking cursor appears in the parameter value of start phase. Turn the **knob** to change the value directly, or use the **numeric keypad** to input the desired value and choose the unit.

Output Square Wave

Press , the screen displays the user interface of the square wave. The Square waveform parameters can be set by operating the Square setting menu on the right. The square wave menu includes: **Frequency/Period**, **Amplitude/High Level**, **Offset/Low Level**, and **Start Phase**.

To set the Frequency/Period, Amplitude/High Level, Offset/Low Level, Start Phase, please refer to *Output Sine Wave* on page 14.

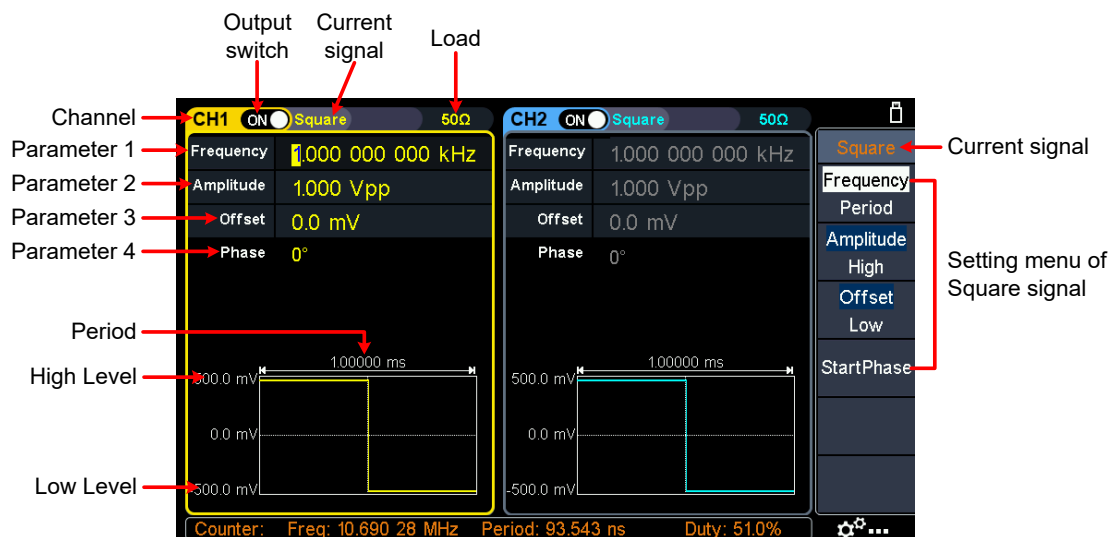



Figure 5-3: Square wave user interface

Output Ramp Wave

Press , the screen displays the user interface of the ramp wave. The Ramp waveform parameters can be set by operating the Ramp setting menu on the right.

The ramp menu includes: **Frequency/Period**, **Amplitude/High Level**, **Offset/Low Level**, **Start Phase**, and **Symmetry**.

To set the Frequency/Period, Amplitude/High Level, Offset/Low Level, Start Phase, please refer to *Output Sine Wave* on page 14.

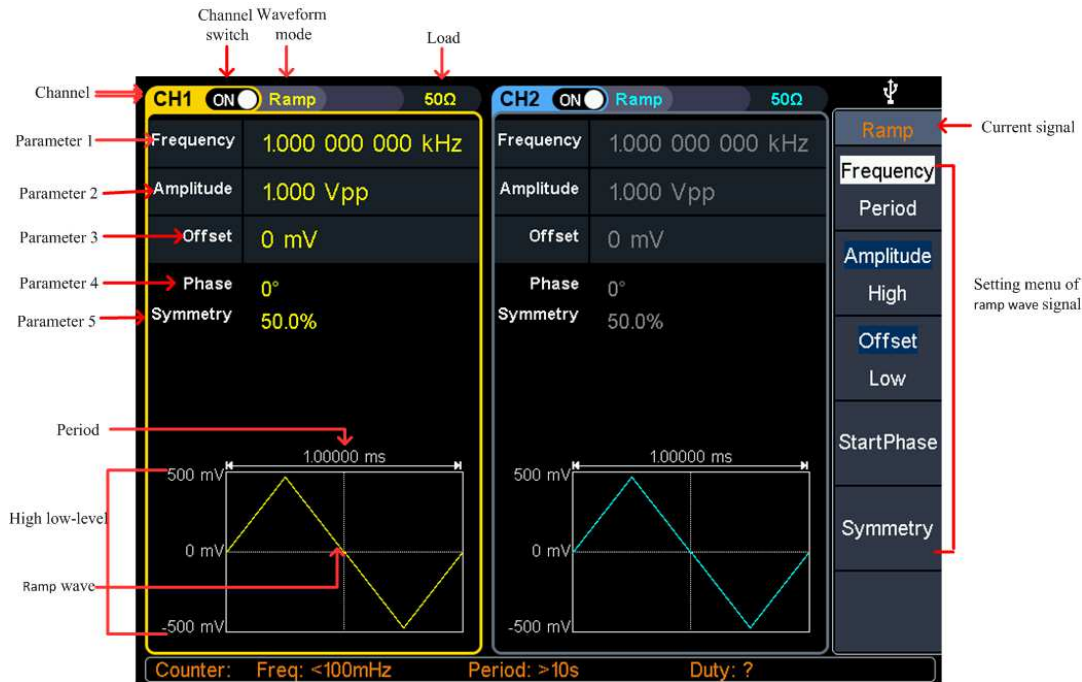

Figure 5-4: Ramp wave user interface

Set the symmetry

Press the **Symmetry** softkey, the **Symmetry** menu item is highlighted. In **Parameter 5** of Figure 5-4, a blinking cursor appears in the parameter value of symmetry. Turn the **knob** to change the value directly, or use the **numeric keypad** to input the desired value and choose the unit.

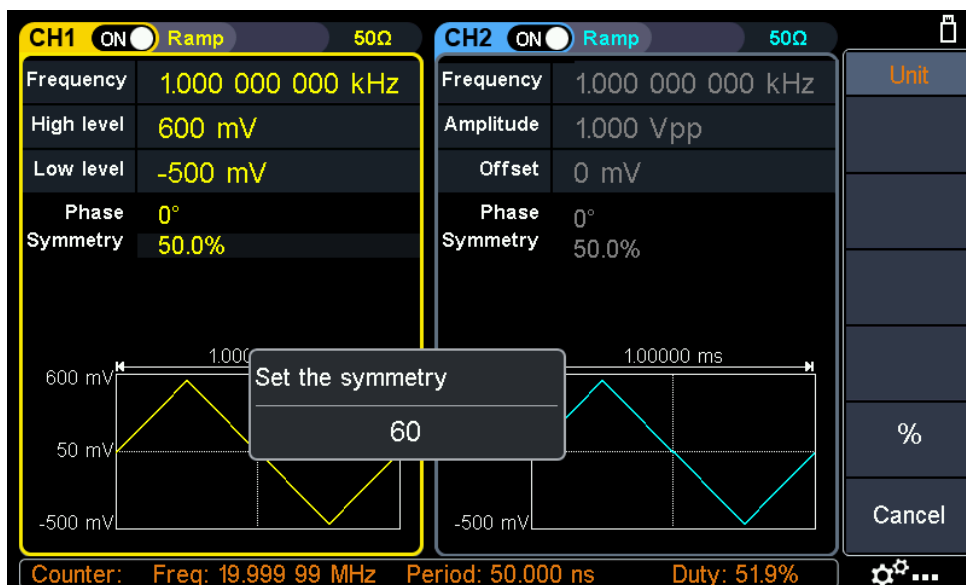



Figure 5-5: Set the symmetry of ramp wave

Glossary

Symmetry: Sets the percentage of the period during which the ramp waveform is rising.

Output Pulse Wave

Press , the screen displays the user interface of the pulse wave. The Pulse waveform parameters can be set by operating the Pulse setting menu on the right. The pulse wave menu includes: **Frequency/Period**, **Amplitude/High Level**, **Offset/Low Level**, **Start Phase**, **Pulse Width/Duty Cycle**, and **Rising Time/Falling Time**.

To set the Frequency/Period, Amplitude/High Level, Offset/Low Level, Start Phase, please refer to *Output Sine Wave* on page 14.

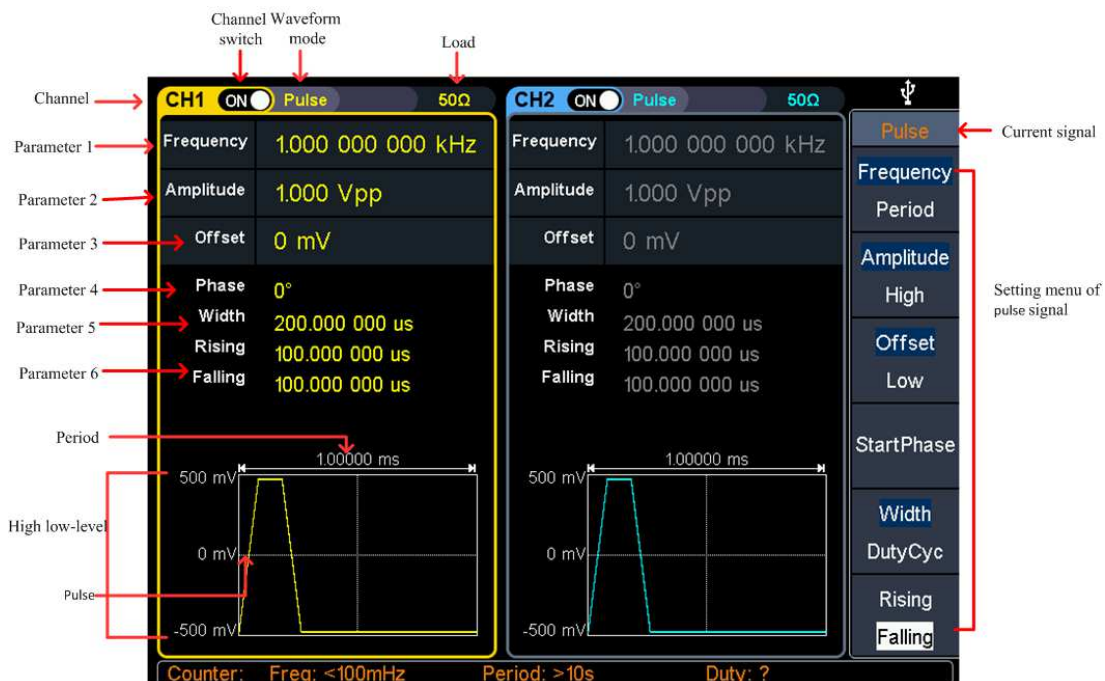

Figure 5-6: Pulse wave user interface

Set the pulse width/duty cycle

Press the **Width/DutyCyc** softkey, the chosen menu item is highlighted. Press the **Width/DutyCyc** softkey to switch between Pulse Width and Duty Cycle. In **Parameter 5** of Figure 5-6, a blinking cursor appears in the parameter value. Turn the **knob** to change the value directly, or use the **numeric keypad** to input the desired value and choose the unit.

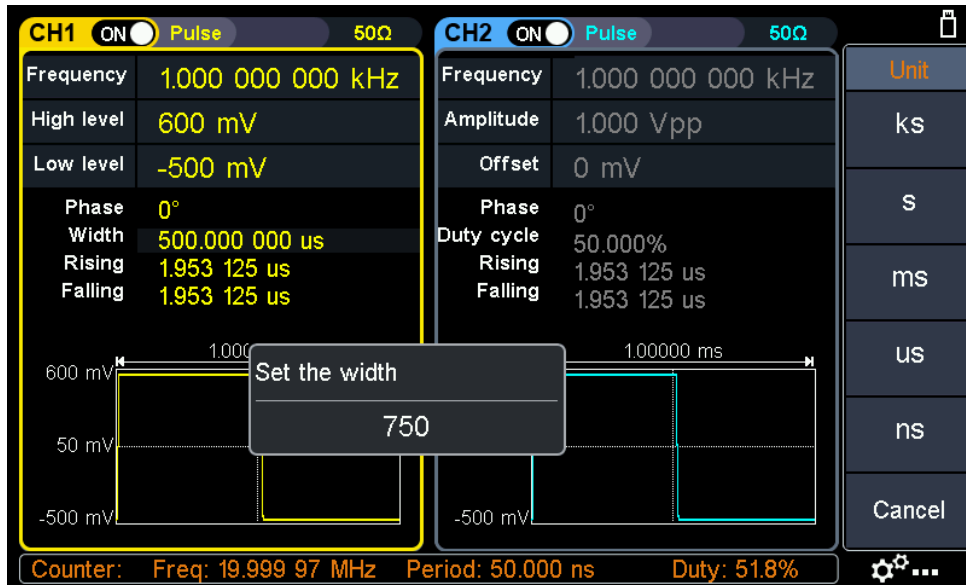

Figure 5-7: Set the pulse width

Glossary

Pulse Width

PW is an abbreviation for pulse width and is divided into positive pulse width and negative pulse width.

The positive pulse width is the time interval from 50% of the rising edge to 50% of the adjacent falling edge.

The negative pulse width is the time interval from 50% of the falling edge to 50% of the adjacent rising edge.

The pulse width is determined by the period and duty cycle of the signal. The calculation formula is pulse width = period * duty cycle.

Duty Cycle

In a series of ideal pulse sequences (such as a square wave), the ratio of the duration of the positive pulse to the total pulse period.

Pulse/Duty Cycle

The pulse width is defined as the time interval from the 50% threshold of the amplitude of the rising edge of the pulse to the 50% threshold of the amplitude of the next falling edge, as shown in the following figure.

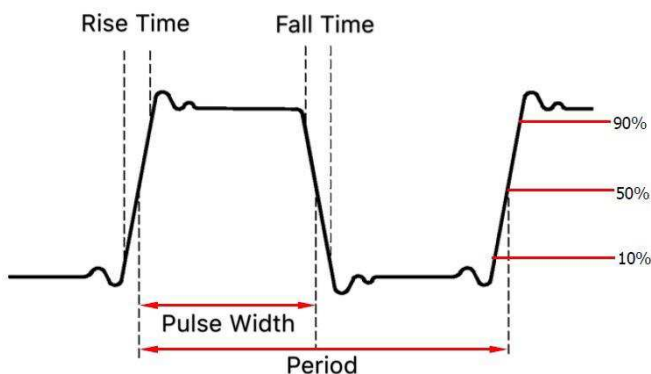

- The settable range of pulse width is limited by the "minimum pulse width" and "pulse period"
 $\text{Pulse width} \geq \text{minimum pulse width}$
 $\text{Pulse width} \leq \text{pulse period} - \text{minimum pulse width}$
- The pulse duty cycle is defined as the pulse width as a percentage of the pulse period.
- The pulse duty cycle is associated with the pulse width, and modifying one of the parameters will automatically modify the other parameter. The pulse duty cycle is limited by the "minimum pulse width" and "pulse period".
 $\text{Pulse duty cycle} \geq \text{minimum pulse width} \div \text{pulse period} \times 100\%$
 $\text{Pulse duty cycle} \leq (1 - 2 \times \text{minimum pulse width} \div \text{pulse period}) \times 100\%$

Set the rising/falling time

Press the **Rising/Falling** softkey, the chosen menu item is highlighted. Press the **Rising/Falling** softkey to switch between Rising Time and Falling Time. In **Parameter 6** of Figure 5-6, a blinking cursor appears in the parameter value. Turn the **knob** to change the value directly, or use the **numeric keypad** to input the desired value and choose the unit.

Output Noise Wave

The noise wave which the generator output is white noise. Press , the screen displays the user interface of the noise wave. The Noise waveform parameters can be set by operating the Noise setting menu on the right.

The noise wave has no frequency and periodic parameters.

The noise wave menu includes: **Amplitude/High Level, Offset/Low Level**.

To set the Amplitude/High Level, Offset/Low Level, please refer to *Output Sine Wave* on page 14.



Figure 5-8: Noise wave user interface

Output Arbitrary Wave

Press , the screen displays the user interface of the arbitrary wave. The Arbitrary waveform parameters can be set by operating the Arbitrary setting menu on the right.

The arbitrary wave menu includes: **Frequency/Period, Amplitude/High Level, Offset/Low Level, Start Phase,** and **Built-in Waveform.**

To set the Frequency/Period, Amplitude/High Level, Offset/Low Level, Start Phase, please refer to *Output Sine Wave* on page 14.

The Arbitrary signal consists of two types: the system built-in waveform and the user-definable waveform.

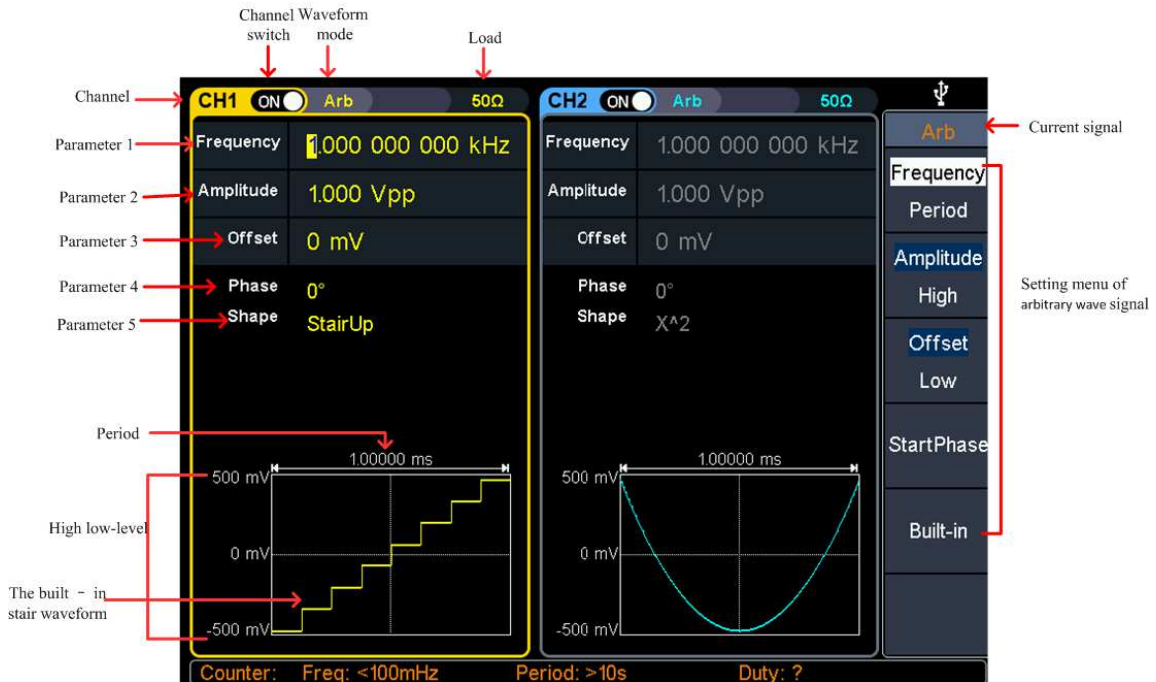



Figure 5-9: Arbitrary wave user interface

Select build-in wave (including DC)

There are 152 types of waveforms built in the generator, the number of waveform points is 8192 points, and the highest upper limit frequency is 15MHz. To select a built-in waveform, the steps are as follows:

- (1) Press the  **Arb** wave button, then press the **Built-in** softkey to enter the built-in wave menu.
- (2) Press **Common**, **Medical treatment**, **Standard**, **Maths** softkeys to select the built-in wave type. Press **NextPage** softkey to enter the next page, select the built-in wave type: **Trigonometric**, **Window function**, **Engineering**, and **Seg Mod** (Segmentation Modulation). Press **NextPage** softkey to enter the next page, select the built-in wave type **Fan test**.

For example, select **Common** to enter the interface shown below.

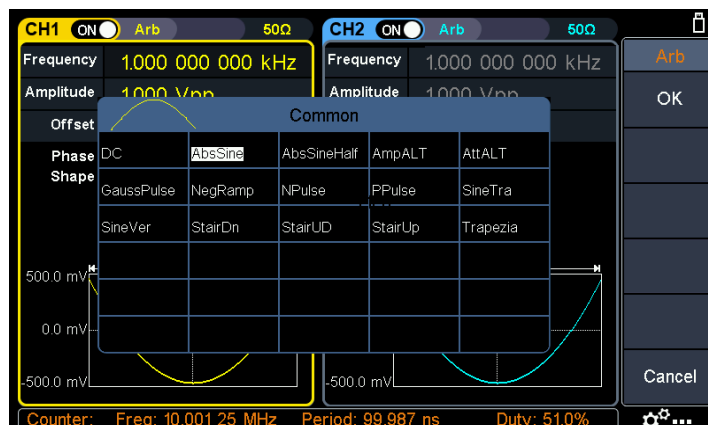

(3) Turn the **knob** to select the desired waveform, for example, select **AbsSine**. Press the **OK** softkey to enter the Airy function.

Note: DC is a type of built-in waveform, located in the **Common** type, named "DC".

Built-in wave list

Name	Description
Common	
DC	Direct current
AbsSine	Absolute sine
AbsSineHalf	Absolute half-sine
AmpALT	Gain oscillation curve
AttALT	Attenuation oscillation curve
GaussPulse	Gauss pulse
NegRamp	Negative ramp
NPulse	Negative pluse
PPulse	Positive pluse
SineTra	Sine-Tra wave
SineVer	Sine-Ver wave
StairDn	Stair downward
StairUD	Stair upward/downward
StairUp	Stair upward
Trapezia	Trapezia
Medical treatment	
Heart	Heart
Cardiac	Cardiac
LFPulse	Low frequency pulse electrotherapy waveform
Tens1	Neuroelectric stimulation therapy waveform 1
Tens2	Neuroelectric stimulation therapy waveform 2
Tens3	Neuroelectric stimulation therapy waveform 3
EOG	Electrooculogram
EEG	electroencephalogram
Pulseilogram	Ordinary pulse curve

5. Panel Operation

ResSpeed	Ordinary expiratory flow rate curve
Standard	
Ignition	Automobile internal combustion engine ignition waveform
TP2A	Automotive transients due to inductance in the wiring
ISP	Automobile starting profile with oscillation
VR	Working voltage profile of the car when resetting
TP1	Automotive transients due to power cuts
TP2B	Car transients due to startup switching off
TP4	Car working profile during start-up
TP5A	Car transients due to the power cut of battery
TP5B	Car transients due to the power cut of battery
SCR	Sintering temperature release map
Surge	Surge signal
Maths	
Airy	Airy function
Besselj	Type I Bessel function
Bessely	Type II Bessel function
Cauchy	Cauchy distribution
X^3	Cubic function
Erf	Error function
Erfc	Remnant error function
ErfcInv	Anti-complement error function
ErfInv	Inverse error function
Dirichlet	Dirichlet function
ExpFall	Exponential decline function
ExpRise	Exponential rise function
Laguerre	Four Laguerre polynomials
Laplace	Laplace distribution
Legend	Five Legendre polynomials
Gauss	Gaussian distribution, also known as the normal distribution
HaverSine	Semi-positive function
Log	Base 10 logarithmic function
LogNormal	Lognormal distribution
Lorentz	Lorentz function
Maxwell	Maxwell distribution
Rayleigh	Rayleigh distribution
Versiera	Tongue line
Weibull	Weber distribution
Ln(x)	Natural logarithmic waveform
X^2	Square function
Round	Round wave
Chirp	Linear frequency modulation
Rhombus	Diamond wave

5. Panel Operation

Trigonometric function	
CosH	Hyperbolic cosine
Cot	Cotangent function
CotH	Hyperbolic cotangent
CotHCon	Concave hyperbolic cotangent
CotHPro	Raised hyperbolic cotangent
CscCon	Recessed cosecant
Csc	Cosecant
CscPro	Raised cosecant
Csch	Hyperbolic cosecant
CschCon	Depressed hyperbolic cosecant
CschPro	Raised hyperbolic cosecant
RecipCon	Reciprocal of the depression
RecipPro	Raised countdown
SecCon	Depression secant
SecPro	Raised secant
SecH	Hyperbolic secant
Sinc	Sinc function
SinH	Hyperbolic sine
Sqrt	Square root function
Tan	Tangent function
TanH	Hyperbolic tangent
ACos	Inverse cosine function
ACosH	Inverse hyperbolic cosine function
ACot	Anti-cotangent function
ACotCon	Inverse cotangent function
ACotPro	Raised inverse cotangent function
ACotH	Inverse hyperbolic cotangent function
ACotHCon	Inverse hyperbolic cotangent function
ACotHPro	Raised inverse hyperbolic cotangent function
Acsc	Anti-cosecting function
ACscCon	Concave inverse cosecting function
ACscPro	Raised anti-cosecting function
AcscH	Anti-hyperbolic cosecant
ACscHCon	Inverse hyperbolic cotangent function
ACscHPro	Raised inverse hyperbolic cosecant function
Asec	Inverse cut function
ASecCon	Inverse tangent function
ASecPro	Raised arctangent function
ASecH	Inverse hyperbolic secant function
ASin	Inverse sine function
ASinH	Inverse hyperbolic sine function
ATan	Arc tangent function

5. Panel Operation

ATanH	Inverse hyperbolic tangent function
Window function	
Bartlett	Bartlett window
BarthannWin	Modified Bartlett window
Blackman	Blackman window
BlackmanH	BlackmanH window
BohmanWin	BohmanWin window
Boxcar	Rectangular window
ChebWin	Chebyshev window
FlattopWin	Flat top window
Hamming	Hamming window
Hanning	Hanning window
Kaiser	Kaiser window
NuttallWin	The smallest four Blackman-Harris windows
ParzenWin	Parzen window
TaylorWin	Taylor window
Triang	Triangle window, also call Fejer window
TukeyWin	Tukey window
Engineering Window	
Butterworth	Butterworth filter
Combin	Combined function
CPulse	C-Pulse signal
CWPulse	CW pulse signal
RoundHalf	Half-round wave
BandLimited	Band limited signal
BlaseiWave	Blasting vibration "time-vibration speed" curve
Chebyshev1	Type I Chebyshev filter
Chebyshev2	Type II Chebyshev filter
DampedOsc	Damped oscillation "time-displacement" curve
DualTone	Dual audio signal
Gamma	Gamma signal
GateVibar	Gate self-vibration signal
LFMPulse	Chirp signal
MCNoise	Mechanical construction noise
Discharge	NiMH battery discharge curve
Quake	Seismic wave
Radar	Radar signal
Ripple	Ripple
RoundsPM	RoundsPM wave
StepResp	Step response signal
SwingOsc	Swing oscillation kinetic energy-time curve
TV	TV signal
Voice	Voice signal

Segement Modulation	
AM	Sinusoidal segmented AM wave
FM	Sinusoidal segmented FM wave
PM	Sinusoidal segmented PM wave
PWM	Pulse width segmented PWM wave
Fan test	
64n/1024	Order adjustment (n is an integer, the range is 0 - 16)

Output Harmonic Wave

Press the  **Harmonic** wave button, the screen displays the user interface of the harmonic wave. The Harmonic waveform parameters can be set by operating the Harmonic setting menu on the right.

The harmonic wave menu includes: **Frequency/Period, Amplitude/High Level, Offset/Low Level, Start Phase, Harmonic Type, Harmonic Order, Sequence Number, Harmonic Amplitude, Harmonic Phase.**

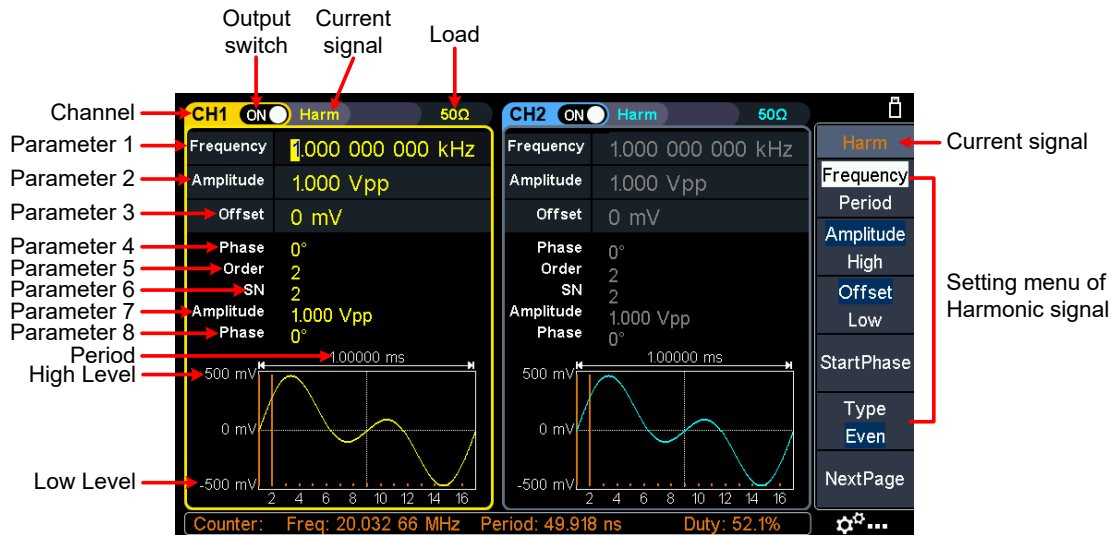

Figure 5-10: Harmonic wave user interface

Harmonic wave function overview

According to Fourier transform theory, time domain waveform is the superposition of a series of sine waveforms, expressed by the following equation:

$$f(t) = A_1 \sin(2\pi f_1 t + \varphi_1) + A_2 \sin(2\pi f_2 t + \varphi_2) + A_3 \sin(2\pi f_3 t + \varphi_3) + \dots$$

Generally, the component of frequency f_1 is called the fundamental wave, f_1 is the fundamental waveform frequency, A_1 is the fundamental waveform amplitude, and φ_1 is the fundamental waveform phase. The frequencies of other component are all integral multiples of the fundamental waveform frequency, which is called harmonic. A component whose frequency is an odd multiple of the fundamental frequency is called an odd harmonic, and a component whose frequency is an even multiple of

the fundamental frequency is called an even harmonic.

This waveform generator can output up to 16th order of harmonic. After selecting CH1 or CH2, press the  **Harmonic** wave button to enter the harmonic setting menu. You can set the parameters of the fundamental waveform, select the type of harmonic, specify the highest order of harmonic, and set the amplitude and phase of each order of harmonic.

Set the Fundamental Wave Parameters

To set the fundamental waveform parameters such as Frequency/Period, Amplitude/High Level, Offset/Low Level, Start Phase, please refer to *Output Sine Wave* on page 14.

Select the harmonic type

This generator can output even harmonic, odd harmonic, all orders of harmonic or user-defined orders of harmonic. After entering the harmonic setting menu and press the **Type** softkey to select the desired harmonic type.

- **Even harmonic**
Press the **Type** softkey and switch to **Even**, the generator would output the fundamental wave and even harmonics.
- **Odd harmonic**
Press the **Type** softkey and switch to **Odd**, the generator would output the fundamental wave and odd harmonics.
- **Sequential harmonic**
Press the **Type** softkey and switch to **Sequential**, the generator would output the fundamental wave and each harmonic in sequence.
- **Custom**
Press the **Type** softkey and switch to **Custom**, you can customize the orders of output harmonics. The highest order is 16.
The 16-bit binary data is used to represent the output status of the 16 orders of harmonics respectively, 1 represents enabling the output of the corresponding harmonic, and 0 represents disabling the output of the corresponding harmonic. You only need to use the numeric keypad to modify the value of each data bit (Note: the leftmost bit represents the fundamental wave, which is fixed to **X** and cannot be modified). For example, set the 16-bit data to X001 0000 0000 0001, the generator will output the fundamental wave, the 4th order harmonic, and the 16th order harmonic.
Note: The actual output harmonics are determined by the “**Order**” currently specified.

Set the harmonic order

After entering the harmonic setting menu, press the **NextPage** softkey to enter the

next page, and press the **Order** softkey, the **Order** menu item is highlighted. In **Parameter 5** of Figure 5-10, a blinking cursor appears in the parameter value of order. Turn the **knob** to change the value directly, or use the **numeric keypad** to input the desired value, which can be set from 2 to 16.

Set the harmonic amplitude of each order

After entering the harmonic setting menu, press the **NextPage** softkey to enter the next page.

- (1) **Select the sequence number of the harmonic:** Press the **SN** softkey, the **SN** menu item is highlighted. In **Parameter 6** of Figure 5-10, a blinking cursor appears in the parameter value of SN. Turn the **knob** to change the value directly, or use the **numeric keypad** to input the desired value.
- (2) **Set the amplitude of the selected SN:** Press the **Amplitude** softkey, the **Amplitude** menu item is highlighted. In **Parameter 7** of Figure 5-10, a blinking cursor appears in the parameter value of Amplitude. Turn the **knob** to change the value directly, or use the **numeric keypad** to input the desired value and choose the unit.

Set the harmonic phase of each order

After entering the harmonic setting menu, press the **NextPage** softkey to enter the next page.

- (1) **Select the sequence number of the harmonic:** Press the **SN** softkey, the **SN** menu item is highlighted. In **Parameter 6** of Figure 5-10, a blinking cursor appears in the parameter value of SN. Turn the **knob** to change the value directly, or use the **numeric keypad** to input the desired value.
- (2) **Set the phase for the selected SN:** Press the **Phase** softkey, the **Phase** menu item is highlighted. In **Parameter 8** of Figure 5-10, a blinking cursor appears in the parameter value of Phase. Turn the **knob** to change the value directly, or use the **numeric keypad** to input the desired value and choose the unit.

Output the Modulated Waves

Supported modulation types include: AM (Amplitude Modulation), FM (Frequency Modulation), PM (Phase Modulation), PWM (Pulse Width Modulation), ASK (Amplitude Shift Keying), PSK (Phase Shift Keying), FSK (Frequency Shift Keying), 3FSK (Ternary Frequency Shift Keying), 4FSK (Quadrature Frequency Shift Keying), BPSK (Biphase Phase Shift Keying), QPSK (Quadrature Phase Shift Keying), OSK (Oscillating Keying), SUM (Sum Modulation), DSB-AM (Double-Sideband Amplitude Modulation).

Press the **Mod** function key, then press the **Type** softkey, turn the **knob** to select the modulation type, press the **OK** softkey to enter the setup menu. To turn off the modulation, press the **Mod** function button again.

Note: The following output modulation waveform uses CH1 as an example. If you need to set CH2, please refer to CH1 operation.





AM (Amplitude Modulation)

The modulated waveform consists of the carrier wave and the modulating wave. For AM, the amplitude of the carrier wave varies with the instantaneous voltage of the modulating wave. The AM user interface is shown below.



Figure 5-11: AM user interface

How to set the parameters of AM

- (1) Press the **Mod** function key, then press the **Type** softkey, turn the knob to select **AM**, press the **OK** softkey.
- (2) **Select carrier wave shape:**
The carrier wave can be **Sine**, **Square**, **Ramp**, or **Arbitrary** wave (except DC). Press , , , or  to select a desired carrier wave shape.
- (3) **Set carrier wave parameters:**
Press the **wave shape key** of the selected carrier wave to display the waveform and parameters of the carrier wave. You can change the parameters of the carrier wave. Press **Mod** to return to the modulation mode interface.
- (4) **Select modulating wave source:**
Press the **Source** softkey to select the modulating wave source.
If you select **External**, use the **Mod/FSK/Trig** connector at the rear panel to input the external modulating signal, the AM setting is completed.
If you select **Internal**, continue with the following steps.

(5) Select modulating wave shape:

Press the **Shape** softkey, then press the **Sine**, **Square**, **Ramp**, **Noise**, or **Arb** softkey to select the modulating wave.

(6) Set modulating wave frequency:

Press the **AM Frequency** softkey to set the modulating wave frequency. The range is 2 mHz – 1 MHz (for internal source only).

(7) Set modulation depth:

Press the **Depth** softkey to set the modulation depth. The range is 0% - 120%.

Glossary

AM frequency

The frequency of the modulating waveform.

Modulation Depth

The amplitude range of modulating waveform. In 0% modulation, the output amplitude is half of the specified value. In 100% modulation, the output amplitude is equal to the specified value. For an external source, the depth of AM is controlled by the voltage level of the signal connected to the **Mod/FSK/Trig** connector at the rear panel. +1 V corresponds to the currently set depth 100%.

DSB-AM (Double-Sideband AM)

The generator supports two kinds of amplitude modulation: normal AM and Double Sideband AM. In normal AM, the modulated waveform contains carrier components. As the carrier components do not carry information, the modulation efficiency is low. To improve the modulation efficiency, you can suppress the carrier components on the basis of the normal AM. At this point, all the modulated waveform components carry information. This mode is called DSB-AM (Double Sideband suppressed carrier modulation). The DSB-AM user interface is shown below.

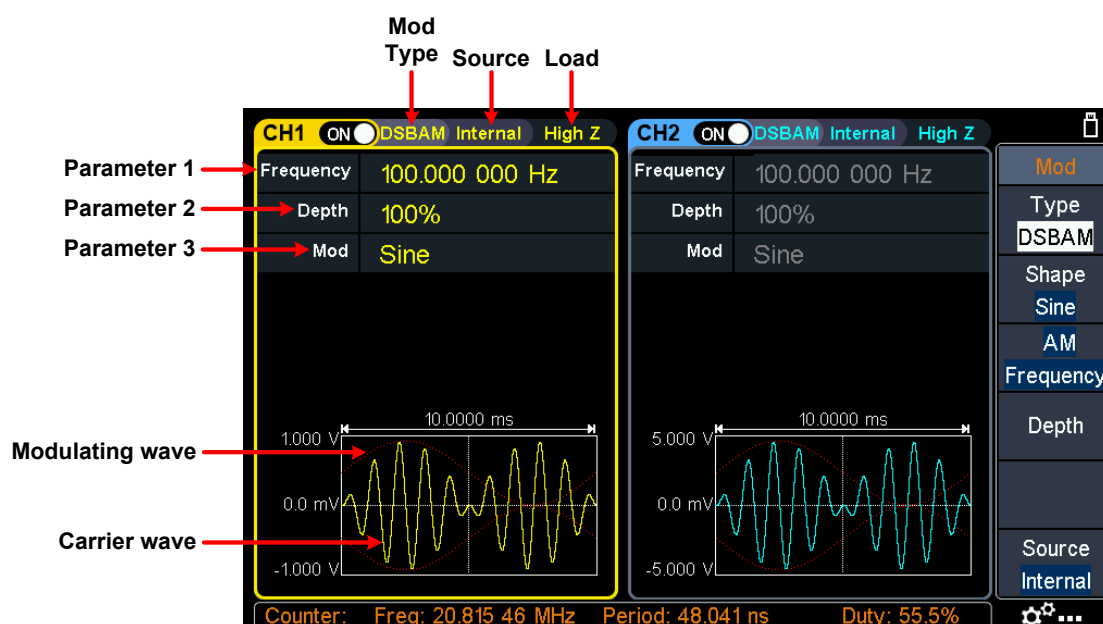





Figure 5-12: DSB-AM user interface

How to set the parameters of DSB-AM

- (1) Press the **Mod** function key, then press the **Type** softkey, turn the **knob** to select **DSBAM**, press the **OK** softkey.
- (2) **Select carrier wave shape:**
The carrier wave can be **Sine**, **Square**, or **Ramp**. Press , , or  to select a desired carrier wave shape.
- (3) **Set carrier wave parameters:**
Press the **wave shape key** of the selected carrier wave to display the waveform and parameters of the carrier wave. You can change the parameters of the carrier wave. Press **Mod** to return to the modulation mode interface.
- (4) **Select modulating wave source:**
Press the **Source** softkey to select the modulating wave source.
If you select **External**, use the **Mod/FSK/Trig** connector at the rear panel to input the external modulating signal, the DSB-AM setting is completed.
If you select **Internal**, continue with the following steps.
- (5) **Select modulating wave shape:**
Press the **Shape** softkey, then press the **Sine**, **Square**, or **Ramp** softkey to select the modulating wave.
- (6) **Set modulating wave frequency:**
Press the **AM Frequency** softkey to set the modulating wave frequency. The range is 2 mHz – 1 MHz (for internal source only).
- (7) **Set modulation depth:**
Press the **Depth** softkey to set the modulation depth. The range is 0% - 100%.

FM (Frequency Modulation)

The modulated waveform consists of the carrier wave and the modulating wave. For FM, the frequency of the carrier wave varies with the instantaneous voltage of the modulating wave. The FM user interface is shown below.

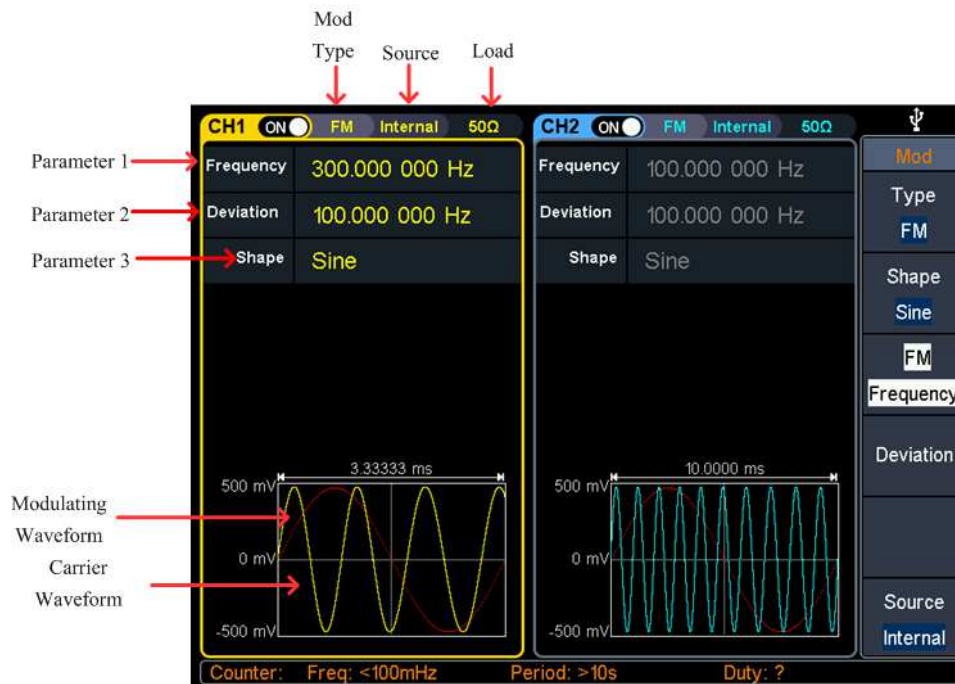





Figure 5-13: FM user interface

How to set the parameters of FM

- (1) Press the **Mod** function key, then press the **Type** softkey, turn the **knob** to select **FM**, press the **OK** softkey.
- (2) **Select carrier wave shape:**
The carrier wave can be **Sine**, **Square**, **Ramp**, or **Arbitrary** wave (except DC). Press , , , or  to select a desired carrier wave shape.
- (3) **Set carrier wave parameters:**
Press the **wave shape key** of the selected carrier wave to display the waveform and parameters of the carrier wave. You can change the parameters of the carrier wave. Press **Mod** to return to the modulation mode interface.
- (4) **Select modulating wave source:**
Press the **Source** softkey to select the modulating wave source.
If you select **External**, use the **Mod/FSK/Trig** connector at the rear panel to input the external modulating signal, then skip ahead to **step (7)**.
If you select **Internal**, continue with the following steps.
- (5) **Select modulating wave shape:**
Press the **Shape** softkey, then press the **Sine**, **Square**, **Ramp**, **Noise**, or **Arb** softkey to select the modulating wave.
- (6) **Set modulating wave frequency:**
Press the **FM Frequency** softkey to set the modulating wave frequency. The range is 2 mHz – 1 MHz (for internal source only).
- (7) **Set frequency deviation:**

Frequency deviation is the deviation of the modulating wave frequency relative to the carrier wave frequency. Press the **Deviation** softkey to set the FM frequency deviation. Frequency deviation range: $2 \text{ mHz} \leq \text{deviation} < \text{upper limit}$ (upper limit is **carrier frequency** or **carrier maximum frequency minus carrier frequency**, the smaller of the two).





PM (Phase Modulation)

The modulated waveform consists of the carrier wave and the modulating wave. For PM, the phase of the carrier wave varies with the instantaneous voltage of the modulating wave. The PM user interface is shown below.



Figure 5-14: PM user interface

How to set the parameters of PM

- (1) Press the **Mod** function key, then press the **Type** softkey, turn the **knob** to select **PM**, press the **OK** softkey.
- (2) **Select carrier wave shape:**
The carrier wave can be **Sine**, **Square**, **Ramp**, or **Arbitrary** wave (except DC). Press , , , or  to select a desired carrier wave shape.
- (3) **Set carrier wave parameters:**
Press the **wave shape key** of the selected carrier wave to display the waveform and parameters of the carrier wave. You can change the parameters of the carrier wave. Press **Mod** to return to the modulation mode interface.
- (4) **Select modulating wave source:**

Press the **Source** softkey to select the modulating wave source.

If you select **External**, use the **Mod/FSK/Trig** connector at the rear panel to input the external modulating signal, then skip ahead to **step (7)**.

If you select **Internal**, continue with the following steps.

(5) Select modulating wave shape:

Press the **Shape** softkey, then press the **Sine**, **Square**, **Ramp**, **Noise**, or **Arb** softkey to select the modulating wave.

(6) Set modulating wave frequency:

Press the **PM Frequency** softkey to set the modulating wave frequency. The range is 2 mHz – 1 MHz (for internal source only).

(7) Set phase deviation:

Phase deviation is the deviation of the modulating wave phase relative to the carrier wave phase. Press the **Deviation** softkey to set the PM phase deviation. The range of phase deviation is from 0° to 180°.

PWM (Pulse Width Modulation)

The modulated waveform consists of the carrier wave and the modulating wave. For PWM, the pulse width of the carrier Pulse wave varies with the instantaneous voltage of the modulating wave. The PWM user interface is shown below.

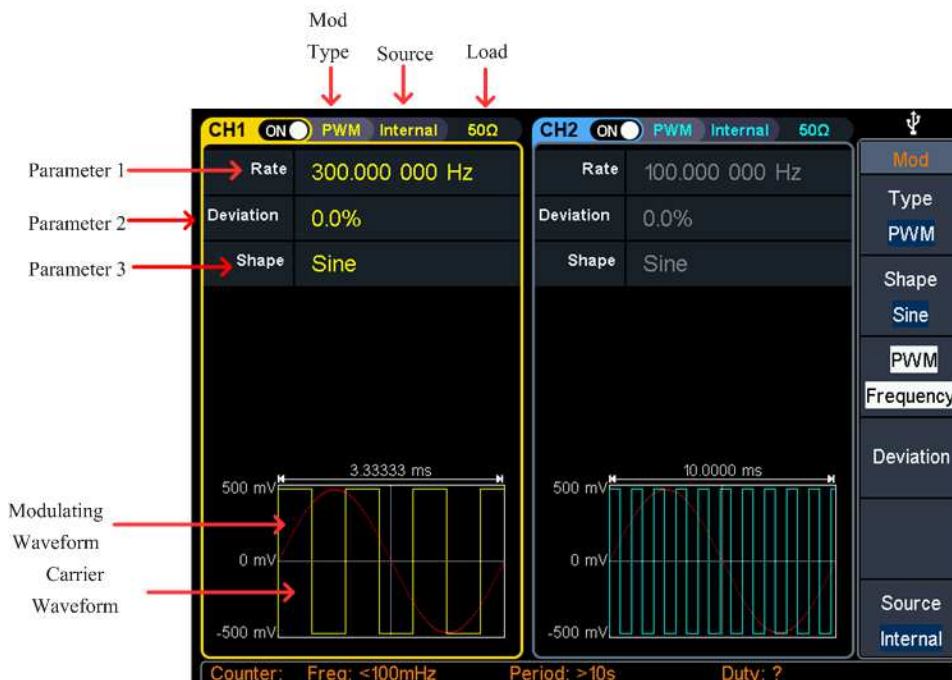



Figure 5-15: PWM user interface

How to set the parameters of PWM

(1) Set carrier wave shape:

PWM can only be used to modulate pulse, so the carrier wave must be **Pulse**.

Press  to set the carrier wave shape.

- (2) Press the **Mod** function key, then press the **Type** softkey, turn the **knob** to select **PWM**, press the **OK** softkey.

Note: If **Pulse** wave has not been selected, **PWM** in the menu is unavailable.

- (3) **Set carrier wave parameters:**

Press  to display the waveform and parameters of the carrier wave. You can change the parameters of the carrier wave. Press **Mod** to return to the modulation mode interface.

- (4) **Select modulating wave source:**

Press the **Source** softkey to select the modulating wave source.

If you select **External**, use the **Mod/FSK/Trig** connector at the rear panel to input the external modulating signal, then skip ahead to **step (7)**.

If you select **Internal**, continue with the following steps.

- (5) **Select modulating wave shape:**

Press the **Shape** softkey, then press the **Sine**, **Square**, **Ramp**, **Noise**, or **Arb** softkey to select the modulating wave.

- (6) **Set modulating wave frequency:**

Press the **PWM Frequency** softkey to set the modulating wave frequency. The range is 2 mHz – 1 MHz (for internal source only).

- (7) **Set duty cycle deviation:**

Duty cycle deviation is the deviation (in %) of the modulating wave duty cycle relative to the original pulse duty cycle. Press the **Deviation** softkey to set the PWM duty cycle deviation.

Duty cycle deviation range: $0\% \leq \text{deviation} \leq \text{upper limit}$ (upper limit is **carrier duty cycle** or **100% minus carrier duty cycle**, the smaller of the two).

ASK (Amplitude Shift Keying)

Amplitude Shift Keying modulation is a modulation technique that shifts the output signal amplitude between two amplitudes: the carrier amplitude and modulating amplitude. Carrier wave amplitude shifts to the modulating amplitude with the specified ASK rate, and then returns to the original amplitude. The ASK user interface is shown below.

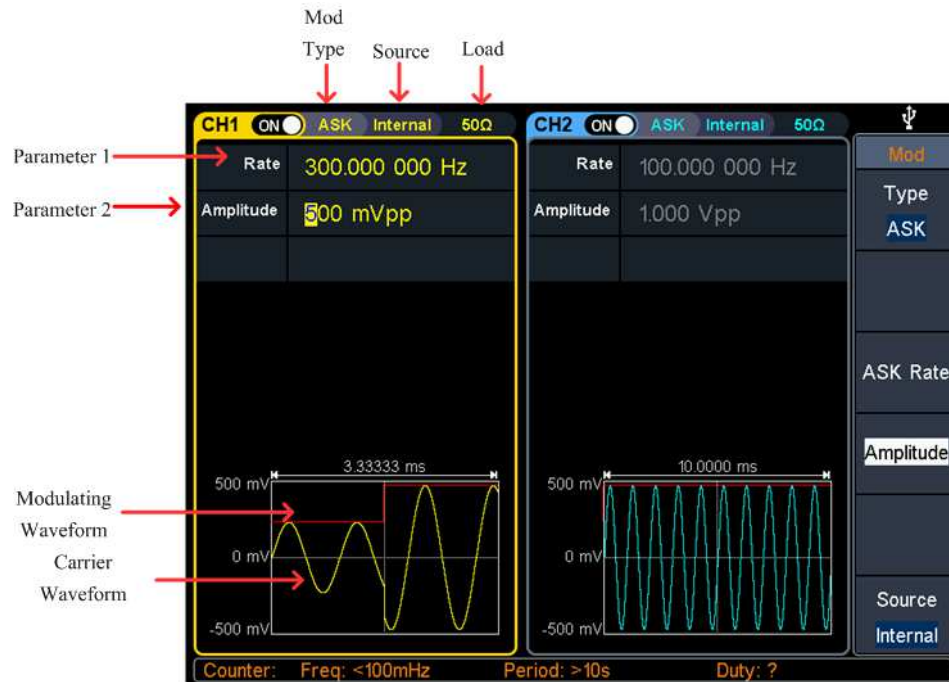





Figure 5-16: ASK user interface

How to set the parameters of ASK

- (1) Press the **Mod** function key, then press the **Type** softkey, turn the **knob** to select **ASK**, press the **OK** softkey.
- (2) **Select carrier wave shape:**
The carrier wave can be **Sine**, **Square**, **Ramp**, or **Arbitrary** wave (except DC). Press , , , or  to select a desired carrier wave shape.
- (3) **Set carrier wave parameters:**
Press the **wave shape key** of the selected carrier wave to display the waveform and parameters of the carrier wave. You can change the parameters of the carrier wave. Press **Mod** to return to the modulation mode interface.
- (4) **Select modulating wave source:**
Press the **Source** softkey to select **Internal** or **External** as the modulating wave source.
- (5) If you select **Internal**, the modulating wave is set as a Square with 50% duty cycle. Press the **ASK Rate** softkey to set the ASK rate. The rate at which the output amplitude shifts between the carrier amplitude and the modulating amplitude is determined by ASK rate (for internal source only). The range is 2 mHz – 1 MHz.

If you select **External**, use the **Mod/FSK/Trig** connector at the rear panel to input the external modulating signal. Press the **Slope** softkey to switch between **Positive** and **Negative** polarity of the modulating wave to control the output amplitude. Set the slope to **Positive**, the generator would output the greater of the carrier amplitude and modulating amplitude when the external input signal is logic high level, and output the lower when the external input signal is logic

low level. The situation is the opposite when the slope is set to **Negative**.

(6) Set modulating amplitude:

Press the **Amplitude** softkey to set the modulating amplitude.

FSK (Frequency Shift Keying)

Frequency Shift Keying modulation is a modulation technique that shifts the output signal frequency between two frequencies: the carrier frequency and hop frequency. The shift frequency (FSK rate) is determined by the internal signal level or signal level offered by the **Mod/FSK/Trig** connector at the rear panel. The FSK user interface is shown below.

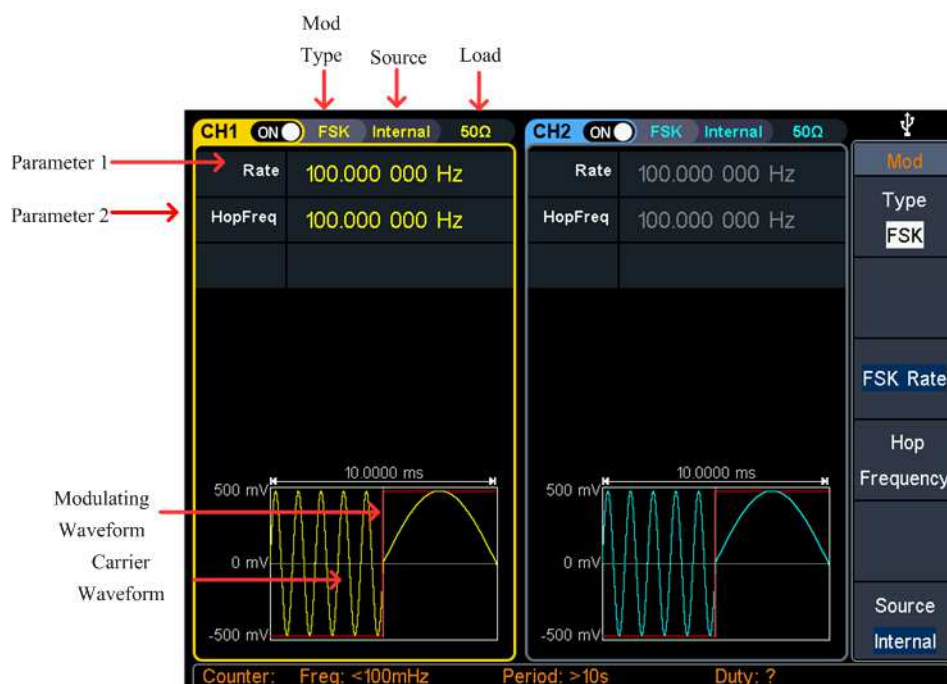





Figure 5-17: FSK user interface

How to set the parameters of FSK

- (1) Press the **Mod** function key, then press the **Type** softkey, turn the **knob** to select **FSK**, press the **OK** softkey.
- (2) **Select carrier wave shape:**
The carrier wave can be **Sine**, **Square**, **Ramp**, or **Arbitrary** wave (except DC). Press , , , or  to select a desired carrier wave shape.
- (3) **Set carrier wave parameters:**
Press the **wave shape key** of the selected carrier wave to display the waveform and parameters of the carrier wave. You can change the parameters of the carrier wave. Press **Mod** to return to the modulation mode interface.
- (4) **Select modulating wave source:**
Press the **Source** softkey to select **Internal** or **External** as the modulating wave

source.

- (5) If you select **Internal**, the modulating wave is set as a Square with 50% duty cycle. Press the **FSK Rate** softkey to set the FSK rate. The rate at which the output frequency shifts between the carrier frequency and the hop frequency is determined by FSK rate (for internal source only). The range is 2 mHz – 1 MHz.

If you select **External**, use the **Mod/FSK/Trig** connector at the rear panel to input the external modulating signal. Press the **Slope** softkey to switch between **Positive** and **Negative** polarity of the modulating wave to control the output frequency. Set the slope to **Positive**, the generator would output the carrier frequency when the external input signal is logic low level, and output the hop frequency when the external input signal is logic high level. The situation is the opposite when the slope is set to **Negative**.

- (6) **Set hop frequency:**

Press the **Hop Frequency** softkey to set the hop frequency. The carrier wave frequency shifts to the hop frequency with the specified FSK rate, and then returns to the original frequency.

PSK (Phase Shift Keying)

Phase Shift Keying modulation is a modulation technique that shifts the output signal phase between two phases: the carrier phase and modulating phase. Carrier wave phase shifts to the modulating phase with the specified PSK rate, and then returns to the original phase. The PSK user interface is shown below.

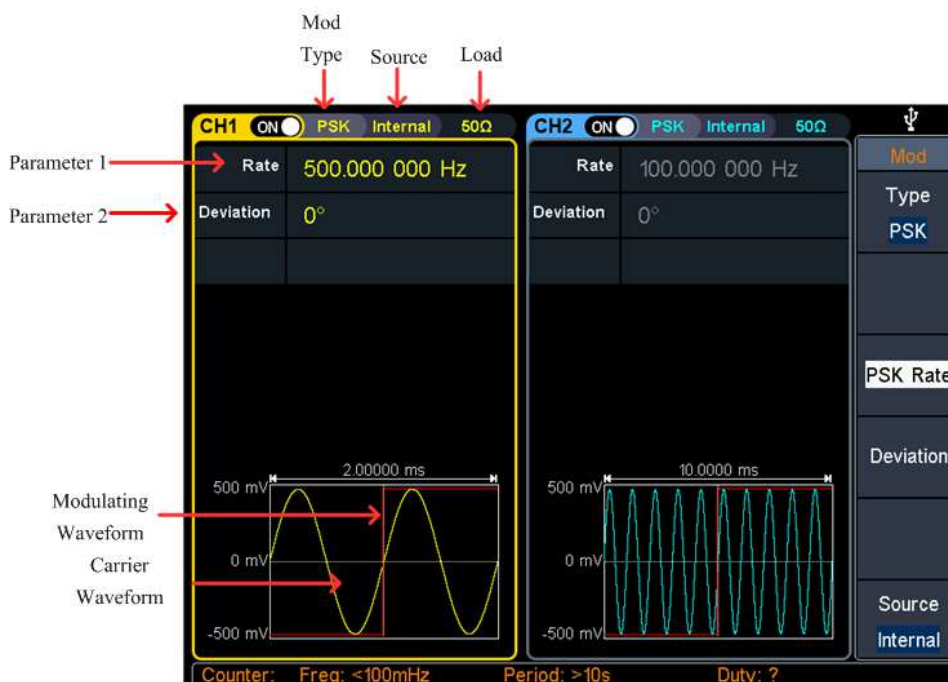





Figure 5-18: PSK user interface

How to set the parameters of PSK

(1) Press the **Mod** function key, then press the **Type** softkey, turn the **knob** to select **PSK**, press the **OK** softkey.

(2) **Select carrier wave shape:**

The carrier wave can be **Sine**, **Square**, **Ramp**, or **Arbitrary** wave (except DC). Press , , , or  to select a desired carrier wave shape.

(3) **Set carrier wave parameters:**

Press the **wave shape key** of the selected carrier wave to display the waveform and parameters of the carrier wave. You can change the parameters of the carrier wave. Press **Mod** to return to the modulation mode interface.

(4) **Select modulating wave source:**

Press the **Source** softkey to select **Internal** or **External** as the modulating wave source.

(5) If you select **Internal**, the modulating wave is set as a Square with 50% duty cycle. Press the **PSK Rate** softkey to set the PSK rate. The rate at which the output phase shifts between the carrier phase and the modulating phase is determined by PSK rate (for internal source only). The range is 2 mHz – 1 MHz.

If you select **External**, use the **Mod/FSK/Trig** connector at the rear panel to input the external modulating signal. Press the **Slope** softkey to switch between **Positive** and **Negative** polarity of the modulating wave to control the output phase. Set the slope to **Positive**, the generator would output the carrier phase when the external input signal is logic low level, and output the modulating phase when the external input signal is logic high level. The situation is the opposite when the slope is set to **Negative**.

(6) **Set PSK phase deviation:**

Press the **Deviation** softkey to set the modulating phase deviation.

3FSK (3 Frequency Shift Keying)

3 Frequency Shift Keying modulation is a modulation technique that shifts the output signal frequency among three preset frequencies: the carrier frequency and two hop frequencies. The shift frequency (3FSK rate) is determined by the internal signal level of the instrument. The 3FSK user interface is shown below.

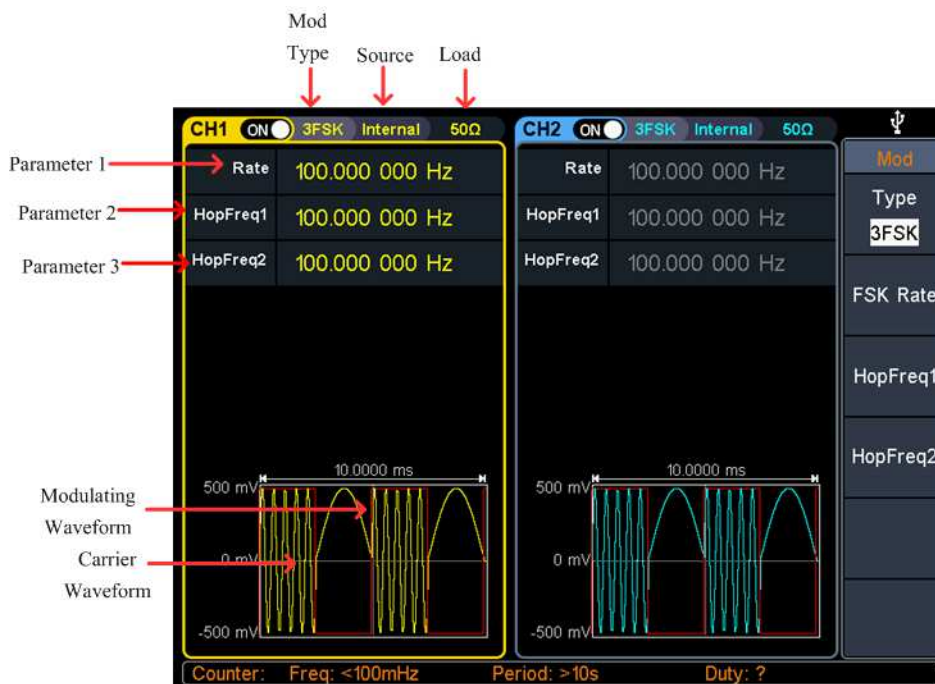





Figure 5-19: 3FSK user interface

How to set the parameters of 3FSK

- (1) Press the **Mod** function key, then press the **Type** softkey, turn the **knob** to select **3FSK**, press the **OK** softkey.
- (2) **Select carrier wave shape:**
The carrier wave can be **Sine**, **Square**, **Ramp**, or **Arbitrary** wave (except DC). Press , , , or  to select a desired carrier wave shape.
- (3) **Set carrier wave parameters:**
Press the **wave shape key** of the selected carrier wave to display the waveform and parameters of the carrier wave. You can change the parameters of the carrier wave. Press **Mod** to return to the modulation mode interface.
- (4) **Modulating wave source:**
3FSK uses internal modulation source, and the modulating wave is set as a Square with 50% duty cycle.
- (5) **Set 3FSK rate:**
Press the **FSK Rate** softkey to set the 3FSK rate. The rate at which the output frequency shifts between the carrier frequency and the two hop frequencies is determined by 3FSK rate (for internal source). The range is 2 mHz – 1 MHz.
- (6) **Set hop frequencies:**
Press the **HopFreq1** and **HopFreq2** softkey to set the two hop frequencies.

4FSK (4 Frequency Shift Keying)

4 Frequency Shift Keying modulation is a modulation technique that shifts the output signal frequency among four preset frequencies: the carrier frequency and three hop frequencies. The shift frequency (4FSK rate) is determined by the internal signal level of the instrument. The 4FSK user interface is shown below.

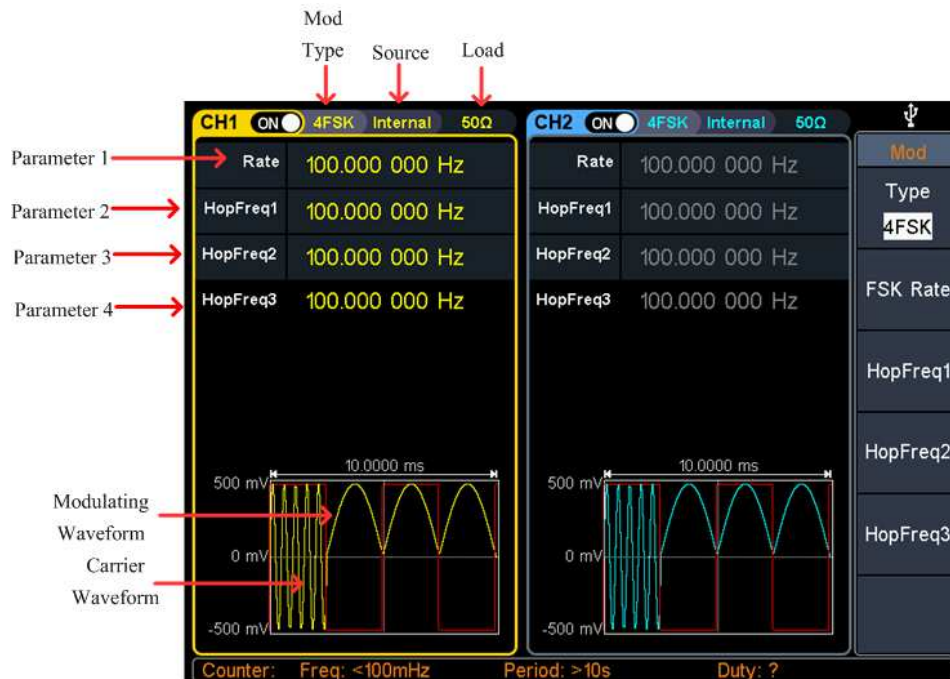





Figure 5-20: 4FSK user interface

How to set the parameters of 4FSK

- (1) Press the **Mod** function key, then press the **Type** softkey, turn the **knob** to select **4FSK**, press the **OK** softkey.
- (2) **Select carrier wave shape:**
The carrier wave can be **Sine**, **Square**, **Ramp**, or **Arbitrary** wave (except DC). Press , , , or  to select a desired carrier wave shape.
- (3) **Set carrier wave parameters:**
Press **the wave shape key** of the selected carrier wave to display the waveform and parameters of the carrier wave. You can change the parameters of the carrier wave. Press **Mod** to return to the modulation mode interface.
- (4) **Modulating wave source:**
4FSK uses internal modulation source, and the modulating wave is set as a Square with 50% duty cycle.
- (5) **Set 4FSK rate:**
Press the **FSK Rate** softkey to set the 4FSK rate. The rate at which the output

frequency shifts between the carrier frequency and the three hop frequencies is determined by 4FSK rate (for internal source). The range is 2 mHz – 1 MHz.

(6) Set hop frequencies:

Press the **HopFreq1**, **HopFreq2** and **HopFreq3** softkey to set the three hop frequencies.

BPSK (Binary Phase Shift Keying)

Binary Phase Shift Keying modulation is a modulation technique that shifts the output signal phase between two phases: the carrier phase and modulating phase. Carrier wave phase shifts to the modulating phase with the specified BPSK rate, and then returns to the original phase. The BPSK user interface is shown below.

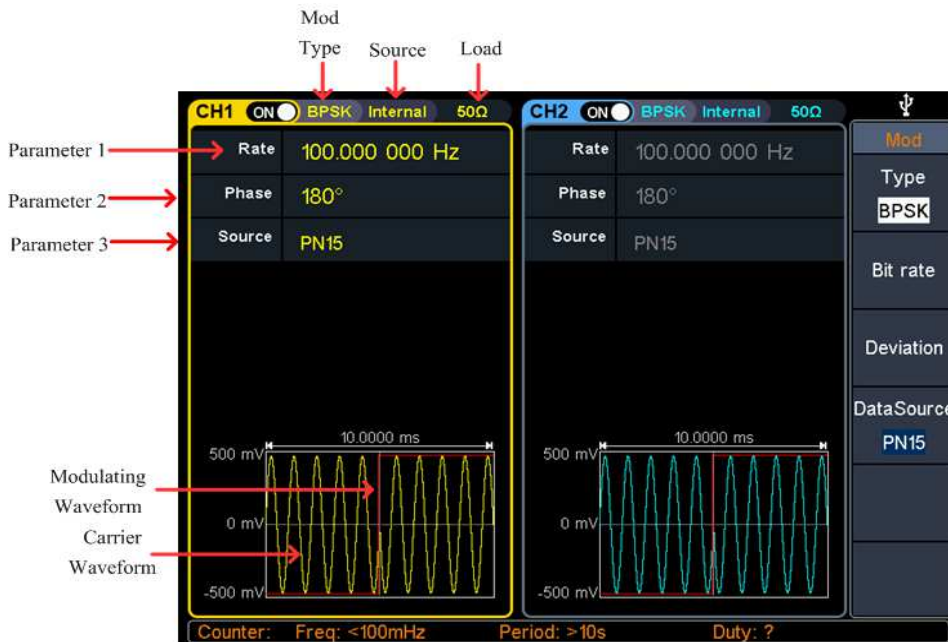





Figure 5-21: BPSK user interface

How to set the parameters of BPSK

- (1) Press the **Mod** function key, then press the **Type** softkey, turn the **knob** to select **BPSK**, press the **OK** softkey.
- (2) **Select carrier wave shape:**
The carrier wave can be **Sine**, **Square**, **Ramp**, or **Arbitrary** wave (except DC). Press , , , or  to select a desired carrier wave shape.
- (3) **Set carrier wave parameters:**
Press the **wave shape key** of the selected carrier wave to display the waveform and parameters of the carrier wave. You can change the parameters of the carrier wave. Press **Mod** to return to the modulation mode interface.

(4) Select modulating wave source:

BPSK uses internal modulation source. Press the **DataSource** softkey to select **PN15**, **PN21**, **01 Patt**, or **10 Patt** as the modulating wave source.

(5) Set BPSK rate:

Press the **Bit rate** softkey to set the BPSK rate. The rate at which the output phase shifts between the carrier phase and the modulating phase is determined by BPSK rate (for internal source). The range is 2 mHz – 1 MHz.

(6) Set BPSK phase deviation:

Press the **Deviation** softkey to set the modulating phase deviation.

QPSK (Quadrature Phase Shift Keying)

Quadrature Phase Shift Keying modulation is a modulation technique that shifts the output signal phase among four preset phases: the carrier phase and three modulating phases. The shift frequency (QPSK rate) is determined by the internal signal level of the instrument. The QPSK user interface is shown below.

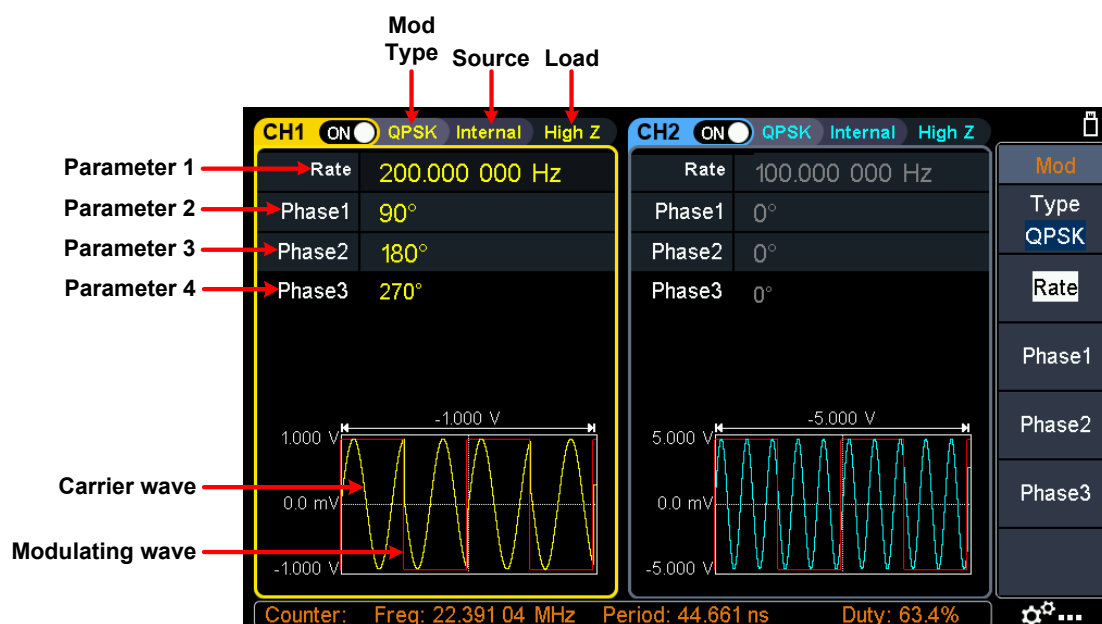





Figure 5-22: QPSK user interface

How to set the parameters of QPSK

- (1) Press the **Mod** function key, then press the **Type** softkey, turn the **knob** to select **QPSK**, press the **OK** softkey.
- (2) **Select carrier wave shape:**
The carrier wave can be **Sine**, **Square**, **Ramp**, or **Arbitrary** wave (except DC). Press , , , or  to select a desired carrier wave shape.

(3) Set carrier wave parameters:

Press the **wave shape key** of the selected carrier wave to display the waveform and parameters of the carrier wave. You can change the parameters of the carrier wave. Press **Mod** to return to the modulation mode interface.

(4) Set QPSK rate:

Press the **Rate** softkey to set the QPSK rate. The rate at which the output phase shifts between the carrier phase and the modulating phase is determined by QPSK rate (for internal source). The range is 2 mHz – 1 MHz.

(5) Set the modulating phases:

Press the **Phase1**, **Phase2** and **Phase3** softkey to set the modulating phases respectively. The range is 0° to 360°.

OSK (Oscillation Shift Keying)

Oscillation Shift Keying modulation is a modulation technique that the generator to output a sine signal with intermittent oscillation. The start-oscillation and stop-oscillation of the internal crystal oscillator are controlled by the internal signal level of the instrument. When the internal crystal oscillator starts to oscillate, the instrument starts to output the carrier waveform and when the internal crystal stops oscillating, the output stops. The OSK user interface is shown below.

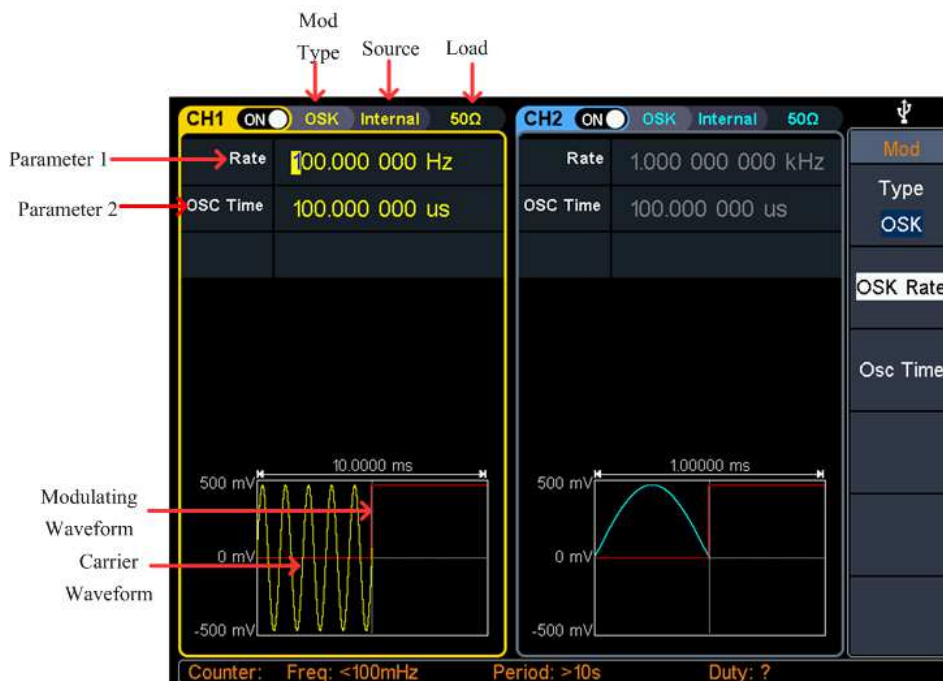



Figure 5-23: OSK user interface

How to set the parameters of OSK

(1) Set carrier wave shape:

OSK carrier wave can only be sine wave. Press  to set the carrier wave shape.

- (2) Press the **Mod** function key, then press the **Type** softkey, turn the **knob** to select **OSK**, press the **OK** softkey.

Note: If **Sine** wave has not been selected, **OSK** in the menu is unavailable.

- (3) **Set carrier wave parameters:**

Press  to display the waveform and parameters of the carrier wave. You can change the parameters of the carrier wave. Press **Mod** to return to the modulation mode interface.

- (4) **Select modulating wave source:**

OSK uses internal modulation source, and the modulating wave is set as a Square with 50% duty cycle.

- (5) **Set OSK rate:**

Press the **OSK Rate** softkey to set the OSK rate. The intermittence time and oscillate time of the output signal is determined by OSK rate (for internal source). The range is 2 mHz – 1 MHz.

- (6) **Set oscillate time:**

Oscillate time is the oscillation period of internal crystal oscillator. The settable range of the oscillate period is related to the OSK rate currently selected. Press the **Osc Time** softkey to set the oscillate time. The range is 8ns - 249.75s.

SUM (Sum Modulation)

The modulated waveform consists of the carrier wave and the modulating wave. For SUM, the amplitude of the carrier wave varies with the instantaneous voltage of the modulating wave. The SUM user interface is shown below.

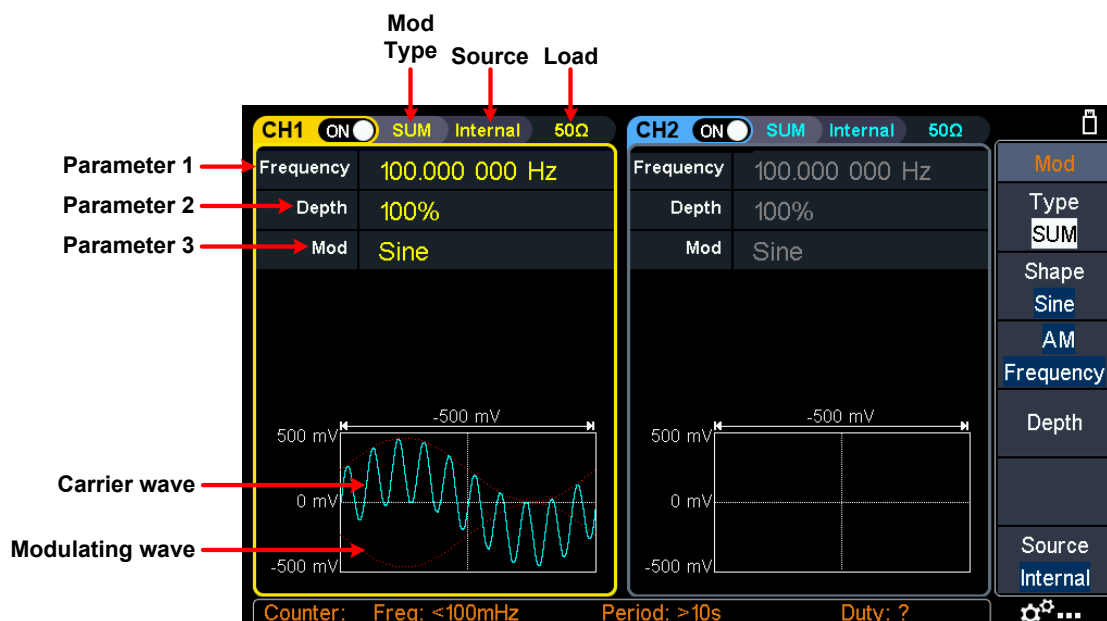





Figure 5-24: SUM user interface

How to set the parameters of SUM

- (1) Press the **Mod** function key, then press the **Type** softkey, turn the **knob** to select **SUM**, press the **OK** softkey.
- (2) **Select carrier wave shape:**
The carrier wave can be **Sine**, **Square**, or **Ramp**. Press , , or  to select a desired carrier wave shape.
- (3) **Set carrier wave parameters:**
Press the **wave shape key** of the selected carrier wave to display the waveform and parameters of the carrier wave. You can change the parameters of the carrier wave. Press **Mod** to return to the modulation mode interface.
- (4) **Select modulating wave source:**
Press the **Source** softkey to select the modulating wave source.
If you select **External**, use the **Mod/FSK/Trig** connector at the rear panel to input the external modulating signal, the SUM setting is completed.
If you select **Internal**, continue with the following steps.
- (5) **Select modulating wave shape:**
Press the **Shape** softkey, then press the **Sine**, **Square**, **Ramp**, **Noise**, or **Arb** softkey to select the modulating wave.
- (6) **Set modulating wave frequency:**
Press the **AM Frequency** softkey to set the modulating wave frequency. The range is 2 mHz – 1 MHz (for internal source only).
- (7) **Set modulation depth:**
Press the **Depth** softkey to set the modulation depth. The range is 0% - 100%.

Generate Sweep (Sweep)

In sweep mode, the generator varies its output from the start frequency to the stop frequency within the specified sweep time. Sweep can be generated by **Sine**, **Square**, **Ramp** or **Arbitrary** wave (except DC).

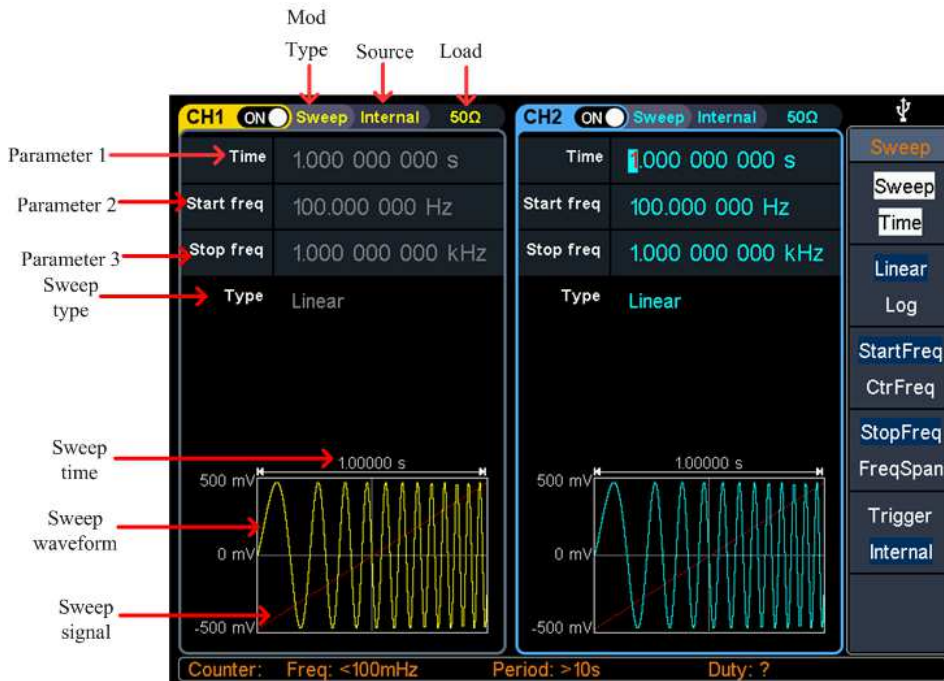







Figure 5-25: Sweep mode user interface

How to set the parameters of Sweep

- (1) When the output signal is **Sine**, **Square**, **Ramp** or **Arbitrary** wave (except DC), press the front panel **Sweep** function key to enter the sweep mode (the backlight of the key lights up).
- (2) Press , , , or  to select the sweep waveform. For example, when selecting a sine wave, press  to display the sweep waveform and parameters, and change the parameters. For details, please refer to *Output Sine Wave* on page 14. Press  or **Sweep** to return to the sweep mode interface.
- (3) Press the **Sweep Time** softkey to set the sweep time, the time span of the sweep for which the frequency changes from the start frequency to stop frequency. The range is from 1ms to 500s.
- (4) Press the **Type** softkey to switch the sweep type.
 - When **Linear** is selected, the output frequency of the instrument varies linearly during the sweep.
 - When **Log** is selected, the output frequency of the instrument varies in a logarithmic fashion during the sweep.
 - When **Step** is selected, the output frequency of the instrument steps from start

frequency to stop frequency. The duration of the output signal on each frequency point is determined by sweep time and step number. Press the **Step** softkey to set the desired step number.

- (5) Start frequency and stop frequency are the upper and lower limits of the frequency for frequency sweep. The generator sweeps from the start frequency to the stop frequency and then returns back to the start frequency. Press the **StartFreq/CtrFreq** softkey to highlight **StartFreq**, note that **StopFreq** in **StopFreq/FreqSpan** is also highlighted, input the desired frequencies.

You can also set the frequency boundaries of frequency sweep through center frequency and frequency span.

$$\text{Center Frequency} = (\text{Start Frequency} + \text{Stop Frequency}) / 2$$

$$\text{Frequency Span} = \text{Stop Frequency} - \text{Start Frequency}$$

Press the **StartFreq/CtrFreq** softkey to highlight **CtrFreq**, note that **FreqSpan** in **StopFreq/FreqSpan** is also highlighted, input the desired frequencies.

For different instrument models and different waveforms, the setting ranges of frequency are different. For detailed information, please refer to **Sweep characteristics** in *Specification* on page 73.

- (6) Press the **Trigger** softkey to select the trigger source.

Internal means using the internal trigger source.

External means using the **Mod/FSK/Trig** connector at the rear panel to input the external trigger signal. A sweep will be generated once the connector gets a TTL pulse with specified polarity. To set the TTL pulse polarity, press the **Slope** softkey to switch between **Positive** and **Negative**.

Manual means using manual trigger. In sweep interface, each time you press the **Trigger** button under the current channel on the front panel, a sweep will be generated.

Generate Burst (Burst)

Press the **Burst** key on the front panel to generate versatile waveforms in burst. Burst can last for certain times of waveform cycle (N-Cycle Burst), or to be controlled by external gated signals (Gated Burst). Burst can apply to **Sine**, **Square**, **Ramp**, **Pulse**, **Noise** (only for gated burst) and **Arbitrary** waveforms.

Glossary

Burst:

The set of pulses transmitted together is called a "burst". The various signal generators are commonly referred to as the BURST function.

N cycle burst:

Contains a specific number of waveform cycles, each of which is initiated by a trigger event.

Gated burst:

Use external department signals to control when waveform burst waveforms are active

Set N-Cycle Burst

In N Cycle mode, the generator will output waveform with specified number of cycles after receiving trigger signal.

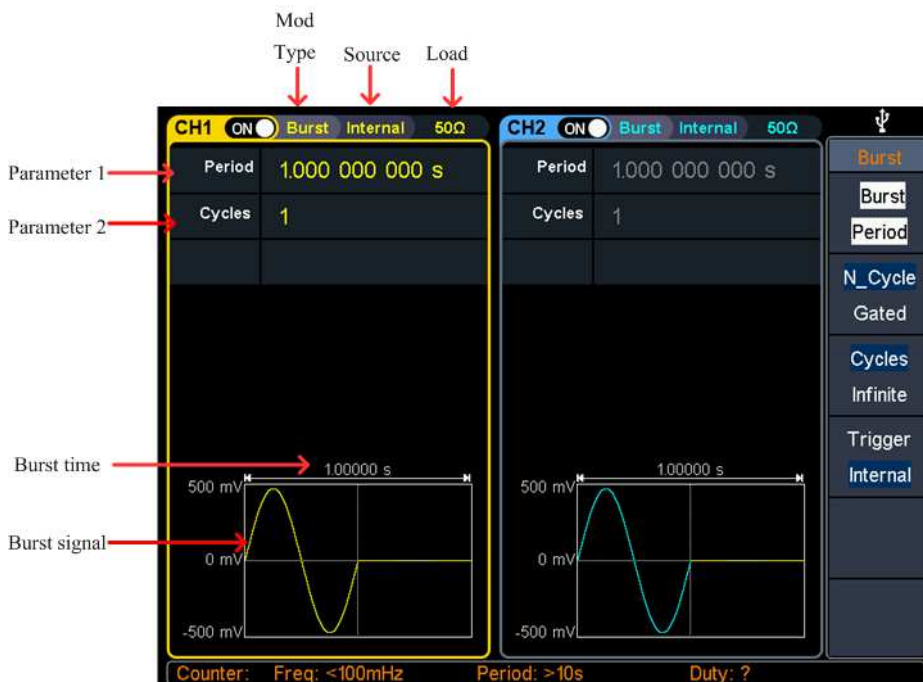









Figure 5-26: N-Cycle burst user interface



- (1) When the output signal is **Sine, Square, Ramp, Pulse** or **Arbitrary** wave (except DC), press the front panel **Burst** function key to enter the burst mode (the backlight of the key lights up).
- (2) Press , , , , or  to select the burst waveform. For example, when selecting a sine wave, press  to display the burst waveform and parameters, and change the parameters. For details, please refer to *Output Sine Wave* on page 14. Press  or **Burst** to return to the burst mode interface.

Note: Before configuring the waveform parameters, you must first select the

channel you want to configure. Press **CH1** or **CH2** to select the corresponding channel, and the corresponding channel area in the user interface will light up.

- (3) Press the **N_Cycle/Gated** softkey to highlight **N_Cycle**.
- (4) Press the **Cycles/Infinite** softkey to highlight **Cycles**, input the number of cycles, which is the number of waveform cycles to be output for each N-cycle pulse train. The range is from 1 to 1 000 000.

When **Infinite** is selected, the cycle number of the waveform is set as an infinite value. The generator outputs a continuous waveform after receiving trigger signal.

Note: In burst mode, the upper limit of the carrier frequency is half of the max frequency of the original carrier. Taking a Sine wave as an example, the maximum frequency is 100 MHz. Press , and set the carrier to 100 MHz, then press the **Burst** mode key, then press , you can see the carrier frequency is changed to 50 MHz.

Note:

- If needed, Burst Period will increase to cater to the specific number of cycles.
 - For an infinite-cycle Burst, **External** or **Manual** Trigger is needed to activate burst.
-

- (5) Burst trigger source could be internal, external or manual. The generator will generate a burst output when a trigger signal is received and then wait for the next trigger. Press the **Trigger** to select the source.

Internal means using the internal trigger source. The generator can only output N-cycle burst and the burst frequency is determined by the burst period. Burst period is only available when **Cycles** and **Internal** trigger is highlighted. Press the **Burst Period** softkey to set the burst period, which is the time from the start of a burst to the start of the next burst. The range is from 20 ns to 500 s (Min = Cycles * Period).

External means using the **Mod/FSK/Trig** connector at the rear panel to input the external trigger signal. A burst will be generated once the connector gets a TTL pulse with specified polarity. To set the TTL pulse polarity, press the **Slope** softkey to switch between **Positive** and **Negative**.

Manual means using manual trigger. In N-cycle burst interface, each time you press the **Trigger** button under the current channel on the front panel, a burst will be generated.

Set Gated Burst









In gated burst mode, the generator controls the waveform output according to the external signal level from the **Mod/FSK/Trig** connector at the rear panel. Gated burst could only be triggered by external trigger source. Waveform functions which

support gated burst are **Sine**, **Square**, **Ramp**, **Pulse**, **Noise** and **Arbitrary** waveforms (except DC).



Figure 5-27: Gated burst user interface

(1) When the output signal is **Sine**, **Square**, **Ramp**, **Pulse**, **Noise** or **Arbitrary** wave (except DC), press the front panel **Burst** function key to enter the burst mode (the backlight of the key lights up).

(2) Press , , , , , or  to select the burst waveform. For example, when selecting a sine wave, press  to display the burst waveform and parameters, and change the parameters. For details, please refer to *Output Sine Wave* on page 14. Press  or **Burst** to return to the burst mode interface.

Note: Before configuring the waveform parameters, you must first select the channel you want to configure. Press **CH1** or **CH2** to select the corresponding channel, and the corresponding channel area in the user interface will light up.

(3) Press the **N_Cycle/Gated** softkey to highlight **Gated**.

(4) Press the **Polarity** softkey to set the gated polarity as **Positive** (or **Negative**). The generator outputs burst waveform only when the gated signal is positive (or negative). When the gated signal is true, the generator outputs a continuous waveform; when the gated signal is false, the generator completes the current period, and then stops and holds on the voltage level corresponding to the initial burst phase of the selected waveform. For Noise waveform, the output will stop immediately once the gated signal becomes false.

Counter

The frequency counter measures signals in the frequency range from 100 mHz to 200 MHz. The **10MHz In/Out/Counter** connector on the rear panel is used by default to receive the frequency counter input signal. The frequency meter works from the start, unless the connector is set to an external clock input or clock output.

- (1) Press the front panel **Counter** function key to enter the frequency counter interface.
- (2) Connect the signal to be tested to the **10MHz In/Out/Counter** connector on the rear panel.
- (3) Set the frequency counter:
 - Press the **Coupling** softkey to switch between AC and DC, to set the coupling mode of the input signal.
 - Press the **Sensitivity** softkey to toggle between Low, Middle or High. For small amplitude signals, the sensitivity is selected to be middle or high. For low frequency large signals or signals with slow rising edges, low sensitivity is selected and the measurement results are more accurate.
 - Press the **HFR** softkey to toggle On or Off high frequency rejection. High-frequency rejection can be used to filter high-frequency factors when measuring low-frequency signals, improving measurement accuracy. When measuring low frequency signals with a frequency less than 1 kHz, turn on high frequency rejection to filter out high frequency noise interference; turn off high frequency rejection when measuring high frequency signals with frequencies greater than 1 kHz.
 - Press the **Trigger Level** softkey. Turn the **knob** to change the current cursor position value, press the arrow keys to move the cursor left or right; or use the **numeric keypad** to enter a value and then select the desired unit from the right menu. The trigger level ranges from -2.5 V to 2.5 V.

After the setting is completed, the frequency counter will measure the signal to be tested at the current setting. If the reading is unstable, repeat the above adjustment until the display is stable.

- (4) The frequency, period, duty cycle, positive pulse width, and negative pulse width can be viewed on the frequency meter interface. If it is not currently in frequency counter interface, the frequency, period and duty cycle can be viewed in the frequency counter bar at the bottom of the screen.

Utility Function Setting

Press the front panel **Utility** function key to enter the utility menu. You can set the parameters of the generator such as: display settings, CH1/2 settings, I/O setup, and system settings. Press **Utility** again to exit the utility menu.

Display Settings

Brightness Control

- (1) Press the front panel **Utility** function key, press the **Display** softkey.
- (2) Press the **Backlight** softkey to select **Backlight**.
- (3) Turn the **knob** to adjust the value on the current cursor, use the **←/→** direction key to move cursor left or right, or use the **numeric keypad** to enter the parameter and then select % as unit. The range is from 0% to 100%.

Screen Saver

If there is no operation within the set screen saver time, the screen enters the protection mode (minimize screen brightness to protect the screen and save energy). Press any key (except the power button) to restore the brightness before entering the screen saver.

- (1) Press the front panel **Utility** function key, press the **Display** softkey.
- (2) Press the **ScrSaver** softkey to select **On** or **Off**.
- (3) At **On** status, you can set the screen saver time. Turn the **knob** to adjust the value on the current cursor, use the **←/→** direction key to move cursor left or right, or use the **numeric keypad** to enter the parameter and then select Minute as unit. The screen saver time range is 1 to 999 minutes.

Separator

The user can set the separator of the screen display data.

- (1) Press the front panel **Utility** function key, press the **Display** softkey.
- (2) Press the **Separator** softkey to toggle between **Comma**, **Space**, and **Off**.

Taking the frequency parameter as an example:

Comma **1.000,000,0**



Space **1.000 000 0**

Off **1.0000000**

Date

- (1) Press the front panel **Utility** function key, press the **Display** softkey.
- (2) Press the **Date** softkey to select **Date**.
- (3) Turn the **knob** to adjust the value on the current cursor, use the **←/→** direction key to move cursor left or right, or use the **numeric keypad** to enter the value.

Contrast

- (1) Press the front panel **Utility** function key, press the **Display** softkey.
- (2) Press the **Contrast** softkey to select **Contrast**.
- (3) Turn the **knob** to adjust the value on the current cursor, use the / direction key to move cursor left or right, or use the **numeric keypad** to enter the parameter and then select % as unit. The range is from 0% to 100%.

CH1/2 Settings

Sync

The generator can output the sync signals of basic waveforms (except noise), arbitrary waveforms (except DC), harmonics, sweep signal, burst signal, and modulated signal from a single channel or two channels at the same time. This sync signal is output from the **Sync** connector at the front panel.

The steps to enable or disable sync signal at the **Sync** connector:

- (1) Press the **Utility** function key, press the **CH1/2 Set** softkey.
- (2) Press the **CH1 Sync** or **CH2 Sync** softkey, press it again to toggle between **On** and **Off**. The default is "On", which sends the sync signal to the **Sync** connector. When the sync signal is disabled, the output level at the **Sync** connector is logic low.

Sync signals of various waveforms

- For sine, square, ramp and pulse waves, the sync signal is a square wave with a 50% duty cycle. When the waveform output is positive, the sync signal is TTL high with respect to the 0V voltage (or DC offset value). When the waveform output is negative, the sync signal is TTL low relative to the 0V voltage (or DC offset value).
- For arbitrary waveform, the sync signal is a square wave with a variable duty cycle. When the output waveform amplitude reaches a certain value, the sync signal is TTL high.
- For harmonics, the sync signal is referenced to the harmonic order and is a square wave with a variable duty cycle. When the output waveform amplitude is positive, the sync signal is TTL high.
- For AM, FM, PM, and PWM, for internal modulation, the sync signal is referenced to the modulation frequency, and the sync signal is a square wave with a 50% duty cycle. In the first half of the modulation waveform, the sync signal is TTL high. When external modulation is performed, there is no sync signal output.
- For ASK, FSK, PSK, BPSK, QPSK, 3FSK, 4FSK, the synchronization signal is referenced to the keying frequency, and the synchronization signal is a square wave with a duty cycle of 50%. There is no sync signal output during external modulation.

- For OSK, the sync signal is referenced to the keyed frequency and the sync signal is a square wave with a 50% duty cycle. When the internal crystal oscillator starts, the sync signal is TTL high.
- For N-cycle bursts, the sync signal is TTL high at the beginning of the burst. At the end of the specified number of cycles, the sync signal is TTL low (if the waveform has an associated start phase, it may not be a zero crossing). For an infinite count pulse train, the sync signal is the same as the sync signal of the continuous waveform.
- For external gated bursts, the sync signal follows its gate signal. Note: This signal does not become TTL low until the end of the last cycle (if the waveform has an associated starting phase, it may not be a zero crossing).

Load

For either of **Out1** and **Out2** connector at the front panel, the generator has a 50Ω fixed serial output impedance. If the actual load does not match the specified value, the voltage level displayed would not match the voltage level of the component under test. This function is used to match the displayed voltage with the expected one.

The step to set the CH1 or CH2 load value is as follows:

- (1) Press the **Utility** function key, press the **CH1/2 Set** softkey.
- (2) Press the **CH1Load** or **CH2Load** softkey, press it again to select **High Z** or *** ohm** ("*" represents a value, the default is 50Ω).
- (3) To change the load value, after selecting *** ohm**, turn the **knob** to adjust the value on the current cursor, use the **←/→** direction key to move cursor left or right, or use the **numeric keypad** to enter the parameter and then select unit. The load range is 1ohm to 10kohm.

Warning: Setup the correct load for right application.

I/O Setup

The generator is configured with USB and LAN interfaces and supports users to configure the interface settings for remote communication. Press **Utility** → **I/O Setup** to open the I/O setting menu, and set the USB device type or the LAN interface setting for remote communication.

USB Device Type

The user can set the communication protocol type of the USB Device interface at the rear panel.

- (1) Press the front panel **Utility** function key, press the **I/O Setup** softkey.
- (2) Press the **USBDEV** softkey to toggle between **PC** and **USBTMC**.
 - **PC:** This is the internal communication protocol. Select this option when

connecting to the Waveform Editor software via the USB Device interface. For details, refer to *Using USB Port* on page 69.

- **USBTMC:** Select this option when you need to use the USBTMC communication protocol standard.

Network Setting

The user can examine network status and configure network settings.

- (1) Press the front panel **Utility** function key, press the **I/O Setup** softkey.
- (2) Press the **Network setting** softkey to go to the submenu: **IP Address, Gateway, Subnet mask, Port**. The physical **Mac address** displayed on the interface cannot be modified.
 - Press the **IP Address** softkey to select **IP Address**. Use the numeric keypad and direction keys to enter the desired IP address. The IP address format is nnn.nnn.nnn.nnn, where nnn ranges from 0 to 255. It is recommended that you acquire an available IP address from your network administrator.
 - Press the **Gateway** softkey to select **Gateway**. Use the numeric keypad and direction keys to enter the desired gateway. The gateway format is nnn.nnn.nnn.nnn, where nnn ranges from 0 to 255. It is recommended that you acquire an available gateway from your network administrator.
 - Press the **Subnet mask** softkey to select **Subnet mask**. Use the numeric keypad and direction keys to enter the desired subnet mask. The subnet mask format is nnn.nnn.nnn.nnn, where nnn ranges from 0 to 255. It is recommended that you acquire an available subnet mask from your network administrator.
 - Press the **Port** softkey to select the **Port**. Use the numeric keypad and direction keys to enter the desired port, which ranges from 0001 to 4000.
- (3) After setting the network parameters of the generator, you need to wait for 2 seconds or more to restart the instrument, the current settings of the LAN parameters will take effect. For details, refer to *Using LAN Port* on page 69.

System Settings

Language

- (1) Press the front panel **Utility** function key, press the **System** softkey.
- (2) Press the **Language** softkey to switch the display language.

Beeper

When the beeper is turned on, the beeper sounds when users operate the front panel or when an error occurs.

- (1) Press the front panel **Utility** function key, press the **System** softkey.
- (2) Press the **Beeper** softkey to toggle between **On** or **Off**.

Clock Source

The generator provides an internal 10MHz clock source and can receive the external clock source from the **10MHz/In/Out/Counter** connector at the rear panel. It can also output an internal clock source from the **10MHz/In/Out/Counter** connector for other devices.

Note:

The amplitude range of the **10MHz In/Out/Counter** input signal is 1 Vpp to 3.3 Vpp.

- (1) Press the front panel **Utility** function key, press the **System** softkey.
- (2) Press the **CLK Ref** softkey to toggle between **Internal** and **External**.

Note:

The clock source defaults to the internal clock source. When an external clock source is required, this function is switched to external. At this time, the clock output is turned off forcibly.

Clock Output

- (1) Press the front panel **Utility** function key, press the **System** softkey.
- (2) Press the **CLK Output** softkey to toggle between **On** and **Off**.

Note:

When the clock source output is turned on, the clock source must be switched to internal, and the counter function stops after the clock output is turned on.

Firmware Update

- (1) Press the front panel **Utility** function key, press the **System** softkey.
- (2) Plug the USB storage device into the USB connector on the front panel of the instrument.
Note: If the USB storage device is not inserted, the **Update firmware** menu is disabled.
- (3) Press the **Update firmware** softkey, turn the **knob** to select **USBDEVICE**, press the **Enter** softkey to enter the USB storage device to browse files.
- (4) Turn the **knob** to select the downloaded firmware file, and press the **Execute** softkey to perform firmware upgrade.

Note:

The firmware file name is as follows: **xxx model _Vx.x.x version.upp**.

If the update process fails, an error code will be displayed on the screen. The following table lists the errors that may occur during the update process.

Error code	Error message
2	File size too large
3	Error reading firmware file
4	CRC (Cyclic Redundancy Check) error
5	Type flag error in the firmware file
6	The firmware version of the instrument can not be updated to the firmware version of the file.
7	The instrument model does not match with the model of the firmware file

Edit the Arbitrary Wave (Edit)

Press the **Edit** function button on front panel to enter the arbitrary wave edit interface.

(1) Set the wave points: Press the **Points** softkey, turn the **knob** to adjust the value or use the numeric keypad, and press the unit softkey. Range between 2 to 100,000.

(2) Select the template:

Press the **Basic Template** softkey to select Blank, Sine wave, Square wave, Ramp wave, and Noise.

Press the **Arb Template** softkey to select a built-in waveform as template.

(3) Edit the wave points: Press **Edit Points** to enter the wave points menu.

- Select **Points**, input the number of point to be edited.
- Select **Voltage**, input the voltage of the point.
- Repeat this step to set all the points.
- Press **Write** to enter the file system interface.

If you want to save the waveform to the internal memory, select INTER and press **Enter** softkey. Turn the knob to select one of the USER files (EditMemory cannot be selected) and press the **Save** softkey. (The file size is displayed on the right side of the USER file. If 0B is displayed, it means the file is empty.)

Description: EditMemory is a temporary data space created, saved, edited or recalled by any arbitrary wave. Saving the waveform is to save the data of this space to the user-specified location (EditMemory is in the memory and never empty). The data in this space is changed after an arbitrary waveform is called, a new waveform is created, or a related programming command is received.

If you want to save to a USB storage device, you need to plug the USB storage device into the front panel USB port. Turn the knob to select USBDEVICE. Press the **Enter** softkey and the instrument will list the directories of the folders and files in the USB storage device. You can turn the knob to select a folder or file. Press the **Enter** softkey to enter the currently selected folder. To return to the parent directory, press the **Back** softkey. After selecting the storage path, press the **SaveAs** softkey and the input keyboard appears on the screen. Turn the knob to select a character. Press the **ABC/abc** softkey to toggle the case of keyboard characters. Press the **Select** softkey to enter the current character. Press the **Delete** softkey to delete the last character that has been entered. Press the **Done** softkey to finish editing and the waveform will be saved in the bin file format under the current path.

- Press Data to CH1 , The edited waveform can be updated to channel 1.
- Press Data to CH2 , The edited waveform can be updated to channel 2.

File Store System (Store)

The storage location is divided into the internal storage (INTER) and the USB device storage (USBDEVICE). When a USB device is connected, the main interface will show "USBDEVICE" and "INTER". Otherwise, the main interface will show "INTER" only.

The internal memory can store 32 arbitrary waveform data.

Press the front panel **Store** function key to enter the file system.

Save the current arbitrary wave

- (1) Press the  Arbitrary Wave button to enter the Arbitrary Wave menu and configure the waveform parameters.
- (2) Press the front panel **Store** function key to enter the file system.
 - If you want to save the current arbitrary waveform to the internal memory, select **INTER** and press the **Arb file** softkey. Turn the knob to select one of the USER files (EditMemory cannot be selected) and press the **Save** softkey. (The file size is displayed on the right side of the USER file. If 0B is displayed, it means the file is empty.)

Description: EditMemory is a temporary data space created, saved, edited or recalled by any arbitrary wave. Saving the waveform is to save the data of this space to the user-specified location (EditMemory is in the memory and never empty). The data in this space is changed after an arbitrary waveform is called, a new waveform is created, or a related programming command is received.

- If you want to save to a USB storage device, you need to plug the USB storage device into the front panel USB interface. Turn the knob to select **USBDEVICE**. Press the **Arb file** softkey and the instrument will list the directories of the folders and files in the USB storage device. You can turn the knob to select a folder or file. Press the **Enter** softkey to enter the currently selected folder. To return to the parent directory, press the **Back** softkey. After selecting the storage path, press the **SaveAs** softkey and the input keyboard appears on the screen. Turn the knob to select a character. Press the **ABC/abc** softkey to toggle the case of keyboard characters. Press the **Select** softkey to enter the current character. Press the **Delete** softkey to delete the last character that has been entered. Press the **Done** softkey to finish editing and the waveform will be saved in the bin file format under the current path.

Bring up arbitrary wave files in internal/external memory

Press the front panel **Store** function key to enter the file system.

- To call up the waveform file in the internal memory, select **INTER** under the memory selection interface and press the **Arb file** softkey. Turn the knob to select a file and press the **CallOut** softkey. If the reading is successful, the screen will prompt "File Read Successful".
Description: The file size is displayed on the right side of the file. If 0B is displayed, the file is empty.
- To recall the waveform file in the USB storage device, turn the knob to select **USBDEVICE** in the memory selection interface. Press the **Arb file** softkey and the instrument will list the directories of the folders and files in the USB storage device. Turn the knob to select a folder or file. Select the file with the suffix of bin and press the **CallOut** softkey. If the reading is successful, the screen will prompt "File Read Successful".

To copy the waveform file from the USB storage device to internal memory:

- After the waveform file in the USB storage device is called up according to the previous step, press the **Back** softkey to return to the upper directory. After returning to the memory selection interface, turn the knob to select **INTER** and press the **Arb file** softkey. Turn the knob to select a USER file and press the **Save** softkey to copy the waveform file to the internal memory.
Description: In the arbitrary waveform interface, Shape displays the storage location or waveform name of the current arbitrary waveform. USER indicates the internal memory, External indicates the USB storage device, and if it is a built-in waveform, the built-in waveform name is displayed.

Erase waveforms from memory

To erase all waveforms from the instrument internal memory:

- (1) Press the front panel **Store** function key to enter the file system.
- (2) Select **INTER** under the memory selection interface, and then press the **Arb file** softkey.
- (3) Press the **Secure** softkey, the screen pops up, and then press the **OK** softkey to erase all waveforms stored in internal memory.

Save/recall Instrument Settings

The instrument settings can be saved as files in internal memory. Up to 16 instrument settings can be saved in the instrument internal memory. The saved settings can be restored from files in the internal memory.

Operation Step:

Press the front panel **Store** function key to enter the file system.

- If you want to save the settings to the internal memory, select **INTER** and press the **Set File** softkey. Turn the knob to select a Setup file and press the **Save** softkey. (The file size is displayed on the right side of the Setup file. If 0B is displayed, it means the file is empty.)
- Note: Press the **Secure** softkey, and then press the **OK** softkey to clear all the settings in the internal memory.
- To recall a setup, select the desired setup, and press the **CallOut** softkey.

Preset Settings (Preset)

Sets the reset setting or power-on setting of the generator.

Restore to the factory setting

- (1) Press the front panel **Preset** function key to enter the preset menu.
- (2) Press the **ResetSet** softkey to select **Factory**.
- (3) Press the **Reset** softkey, and then press the **OK** softkey to restore the generator to the factory default settings.

Table 5-1: The factory default settings

Output Configuration	Factory Setting
CH1 signal output switch	Off

5. Panel Operation

CH2 signal output switch	Off
Function	Sine
Frequency	1 kHz
Amplitude/Offset	1 Vpp / 0 Vdc
Basic Waveform	Factory Setting
Frequency	1 kHz
Period	1 ms
Amplitude	1 Vpp
Offset	0 V
High Level	500 mV
Low Level	-500 mV
Start Phase	0°
Ramp Wave Symmetry	50%
Pulse Width	200 us
Pulse Duty Cycle	20%
Pulse Rising Time	1.953125 us
Pulse Falling Time	1.953125 us
Build-in Wave	X ²
Harmonic Wave Type	Even
Harmonic Wave Order	2
Harmonic Wave SN	2
Harmonic Wave Amplitude	1 Vpp
Harmonic Wave Phase	0°
Modulation Waveform	Factory Setting
Modulation type	AM
AM	
Modulating Waveform	Sine
AM Frequency	100 Hz
Modulation Depth	100%
Modulation Source	Internal
FM	
Modulating Waveform	Sine
FM Frequency	100 Hz
Frequency Deviation	100 Hz

5. Panel Operation

Modulation Source	Internal
PM	
Modulating Waveform	Sine
PM Frequency	100 Hz
Phase Deviation	0°
Modulation Source	Internal
PWM	
Modulating Waveform	Sine
PWM Frequency	100 Hz
Duty Cycle Deviation	0%
Modulation Source	Internal
ASK	
ASK Rate	100 Hz
Modulating Amplitude	1 Vpp
Modulation Source	Internal
PSK	
PSK Rate	100 Hz
PSK Phase Deviation	0°
Modulation Source	Internal
FSK	
FSK Rate	100 Hz
Hop Frequency	100 Hz
Modulation Source	Internal
3FSK	
FSK Rate	100 Hz
Hop Frequency 1	100 Hz
Hop Frequency 2	100 Hz
4FSK	
FSK Rate	100 Hz
Hop Frequency 1	100 Hz
Hop Frequency 2	100 Hz
Hop Frequency 3	100 Hz
BPSK	
Bit Rate	100 Hz

5. Panel Operation

BPSK Phase Deviation	180°
Data Source	PN15
QPSK	
Rate	100 Hz
OSK	
OSK Rate	1 kHz
Oscillate Time	100 us
Sweep	Factory Setting
Sweep Time	1 s
Sweep Type	Linear
Start Frequency	100. Hz
Stop Frequency	1 kHz
Center Frequency	550 Hz
Frequency Span	900 Hz
Trigger Source	Internal
Slope	Positive
Burst	Factory Setting
Burst Period	1 s
Burst Mode	N_Cycle
Number of Cycles	1
Trigger Source	Internal
Slope	Positive
Gated Polarity	Positive
Counter	Factory Setting
Coupling	AC
Sensitivity	Low
High Frequency Reject	On
Trigger Level	0 V
Edit	Factory Setting
Number of Waveform Points	1000
Interpolation	Off
Basic Template	Blank
Save/recall instrument settings	Factory Setting

Reset Settings	Factory
Power On Setting	Last time setting
User Settings	Setup0
Utility	Factory Setting
Backlight	100%
Screen Saver	On
Screen Saver Time	30 Minute
Thousand Separator	Space
CH1 synchronization	Off
CH2 synchronization	Off
CH1 load	50 ohm
CH2 load	50 ohm
USB device	USB TMC
IP Address	192.168.1.99
Gateway	192.168.1.1
Subnet mask	255.255.255.000
Port	3000
Language	Factory Delivery Setting
Beeper	On
Clock Ref	Internal
Between Channels	Factory Setting
Frequency Sync	Off
Amplitude Sync	Off

Restore to the user setting

- (1) To save the current system setting as a user-defined setting, refer to *Save/recall Instrument Settings* on page 63.
- (2) Press the front panel **Preset** function key to enter the preset menu.
- (3) Press the **ResetSet** softkey to select **User**.
- (4) Press the **User** softkey to select the desired user setup file (**Setup0** to **Setup15**).
Note: Before selecting any of **Setup0** to **Setup15**, make sure that valid setting file is stored in the corresponding storage location.
- (5) Press the **Reset** softkey, and press the **OK** softkey to restore the generator to the

selected user-defined setting.

Power-on setting

Set the settings to be used when the instrument is powered on the next time to a specified setting.

- (1) Press the front panel **Preset** function key to enter the preset menu.
- (2) Press the **PowerOn** softkey to select power-on settings as **Last**, **User** or **Factory**.

Last

When powered, restore the generator to the setting at last shutdown.

User

When powered, restore the generator to a user-defined setting.

To save the current system setting as a user-defined setting, refer to *Save/recall Instrument Settings* on page 63.

Press the **User** softkey to select the desired user setup file (**Setup0** to **Setup15**).

Note: Before selecting any of **Setup0** to **Setup15**, make sure that valid setting file is stored in the corresponding storage location.

Factory

When powered, restore the generator to factory default settings. The factory default settings are in *Table 5-1*.

Use Build-in Help (Help)

- (1) To get help about any front panel button or menu softkey, first press the front panel **Help** function button, then press the button you need help with.
- (2) Press the **Help** function button again to exit the help interface.

6. Communicate with PC

Supports communication with a computer via a USB port or a LAN port. Using the Waveform Editor software installed on the computer, the signal generator can be operated on the computer to control the output of the signal generator.

Here's how to connect to a computer. First, install the Waveform Editor software on the CD-ROM on your computer. Then, there are several connection options to choose from.

Using USB Port

- (1) **Set the USB device protocol type of the signal generator:** Press **Utility** → **I/O Setup** → **USBDEV**, switch to PC.
- (2) **Connection:** Connect the **USB Device** interface at the rear panel of the signal generator to the USB interface of the computer with a USB cable.
- (3) **Install the driver:** Run Waveform Editor software on the computer, press F1 to view the built-in help documentation. Follow the instructions to install the driver. The path of the driver is the USBDRV folder in the directory where the Waveform Editor communication software is located, such as "C:\Program Files (x86)\DS_Wave\Waveform Editor\USBDRV".
- (4) **Host computer communication port setting:** Open the Waveform Editor software, click "**Communications**" in the menu bar, select "**Ports-Settings**", in the setting dialog box, select the communication port as "**USB**". After the connection is successful, the connection status prompt in the lower right corner of the software interface turns green.

Using LAN Port

Connect Directly

- (1) **Connection.** Plug one end of the network cable into the LAN connector on the rear panel of the signal generator; the other end is plugged into the LAN interface of the computer.
- (2) **Set the network parameters of the computer.** Since the signal generator does not support automatic IP address acquisition, you need to specify the IP yourself. Here we set the IP address to 192.168.1.71.
- (3) **Set the network parameters of the host computer.** Run Waveform Editor software on the computer. In the "Communications" menu, under "Ports-Settings", select the communication port as "LAN", the IP is set to be the same as the first three fields of the computer's network IP in step (2), and the

last field has a different IP address. It is "192.168.1.99"; the port can be set to any value from 0 to 4000. However, since ports below 2000 are often occupied, it is recommended to set it to 2000 or higher. Here, it is set to "3000".

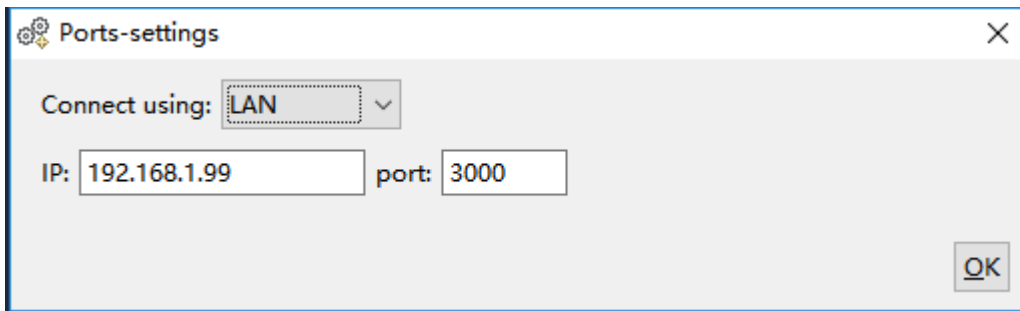

Figure 5-1: Setting the network parameters of the host computer

- (4) Set the network parameters of the signal generator.** In the signal generator, press **Utility** → **I/O Setup** → **Network setting** to enter the submenu. Set the IP address and port to the IP and port in the PC software port settings in step (3). After the shutdown and restart, if the data can be obtained normally in the PC software, the connection is successful.

Connect through a Router

- (1) Connection.** Connect the LAN interface on the rear panel of the signal generator to the router with a network cable. The computer is also connected to the router.
- (2) Set the network parameters of the computer.** Since the signal generator does not support automatic IP address acquisition, you need to specify the IP yourself. The default gateway and subnet mask settings must match the settings of the router. For example, the IP address is set to 192.168.1.71, the subnet mask is set to 255.255.255.0, and the default gateway is set to 192.168.1.1.
- (3) Set the network parameters of the host computer.** Run Waveform Editor software on the computer. In the "Communications" menu, under "Ports-Settings", select the communication port as "LAN", the IP is set to be the same as the first three fields of the computer's network IP in step (2), and the last field has a different IP address. It is "192.168.1.99"; the port can be set to any value from 0 to 4000. However, since ports below 2000 are often occupied, it is recommended to set it to 2000 or higher. Here, it is set to "3000".

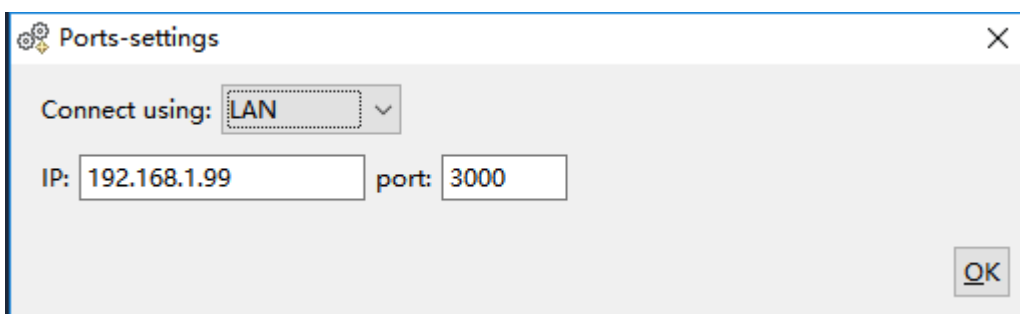

Figure 6-1: Set the network parameters of the host computer

- (4) Set the network parameters of the signal generator.** In the signal generator, press **Utility** → **I/O Setup** → **Network setting** to enter the submenu. Set the IP address and port to the IP and port in the PC software port settings in step (3). The gateway settings need to be the same as the gateway settings of the router. After the shutdown and restart, if the data can be obtained normally in the PC software, the connection is successful.

For the specific operation method of Waveform Editor software, please press F1 to view the built-in help documentation.

7. Troubleshooting

1. The screen is still black and there is no display after you press the power switch, please follow the steps below:

- Check whether the power is connected correctly.
- Check whether the fuse below the power connector meets the specified type and rating and in good condition (the cover can be pried open with a flat-blade screwdriver).
- Restart the instrument after completing the above inspections.
- If the problem still exists, please contact us for our service.

2. The measured value of the output signal amplitude does not match the displayed value:

Check whether the actual load value of the signal is consistent with the load value set in the instrument. Please refer to *Load* on page 57.

If you encounter other problems, please try to reset the settings (see *Restore to the factory setting* on page 63) or restart the instrument. If it still can not work properly, please contact us for our service.

8. Specification

All technical specifications are guaranteed when the following conditions are met, unless otherwise stated.

- The signal generator must be operated continuously for more than 30 minutes at the specified operating temperature (20°C to 30°C) to meet these specifications;
- The signal generator is in the calibration interval and has performed a self-calibration.

In addition to the specifications marked with the word "Typical", the specifications used are guaranteed.

Waveforms

Waveforms		
Bandwidth	XDG2100	100 MHz
	XDG2080	80 MHz
	XDG2060	60 MHz
	XDG2035	35 MHz
Sample Rate	500MSa/s	
Vertical Resolution	14 bits	
Channel	2	
Standard Waveforms	Sine wave, square wave, ramp wave, pulse wave, noise, harmonic	
Arbitrary Waveforms	Sinc, exponential rise, exponential decline, electrocardiogram, Gaussian, semi-positive, Lorentz, dual audio, DC voltage totaling more than 150 kinds	

Frequency Characteristics

Frequency Characteristics (Frequency resolution to 1 μ Hz)		
Sine wave	XDG2100	1 μ Hz - 100 MHz
	XDG2080	1 μ Hz - 80 MHz
	XDG2060	1 μ Hz - 60 MHz
	XDG2035	1 μ Hz - 35 MHz
Square wave	XDG2100	1 μ Hz - 30 MHz
	XDG2080	1 μ Hz - 30 MHz
	XDG2060	1 μ Hz - 30 MHz
	XDG2035	1 μ Hz - 15 MHz
Pulse wave	XDG2100	1 μ Hz - 25 MHz
	XDG2080	1 μ Hz - 25 MHz
	XDG2060	1 μ Hz - 25 MHz
	XDG2035	1 μ Hz - 15 MHz

8.Specification

Ramp wave	1 μ Hz - 3 MHz	
Noise wave (-3 dB)	XDG2100	100 MHz BW
	XDG2080	80 MHz BW
	XDG2060	60 MHz BW
	XDG2035	35 MHz BW
Arbitrary wave	1 μ Hz - 15 MHz	
Harmonic wave	XDG2100	1 μ Hz - 50 MHz
	XDG2080	1 μ Hz - 40 MHz
	XDG2060	1 μ Hz - 30 MHz
	XDG2035	1 μ Hz - 17.5MHz
Frequency resolution	1 μ Hz or 10 significant figures	
Frequency stability	± 2 ppm at 25 ± 5 °C	
Frequency aging rate	± 1 ppm per year	

Amplitude Characteristics

Amplitude Characteristics (not specifically labeled, the load defaults to 50 Ω)	
Output amplitude (load defaults to 50 Ω)	1mVpp to 10Vpp (≤ 25 MHz) 1mVpp to 5Vpp (≤ 60 MHz) 1mVpp to 2.5Vpp (≤ 100 MHz)
Bandwidth flatness (relative to 100 kHz Sine wave, 1 Vpp, 50 Ω)	≤ 10 MHz: ± 0.2 dB ≤ 60 MHz: ± 0.3 dB ≤ 100 MHz: ± 0.5 dB
Amplitude accuracy	$\pm (1\% \text{ of setting} + 1 \text{ mVpp})$ (1kHz sine, 0V offset, > 10 mVpp)
Amplitude resolution	0.1mVpp or 4 digits (The amplitude ≥ 1 Vpp is 1mVpp)
DC offset range (High resistance)	$\pm (10 \text{ Vpk} - \text{Amplitude Vpp} / 2)$
DC offset accuracy	$\pm (1\% \text{ of } \text{setting} + 1 \text{ mV} + \text{amplitude Vpp} * 0.5\%)$
Offset resolution	0.1 mVpp or 4 digits (The amplitude > 1 Vpp is 1 mVpp)
Units	mVpp, Vpp, Vrms, mVrms, dBm
Output Impedance	50 Ω (Typical)
Output protection	Short circuit protection, the output will be automatically turned off when overloaded

Signal Characteristics

Signal Characteristics	
Sine	
Harmonic distortion	Typical (0dBm) DC to 1MHz: < -65 dBc 1MHz to 10MHz: < -60 dBc 10MHz to 60MHz: < -55 dBc 60MHz to 100MHz: < -50 dBc
	Total harmonic distortion
	$< 0.05\%$, 10 Hz to 20 kHz, 1 Vpp

8.Specification

Non-harmonic distortion	Typical (0dBm) $\leq 10\text{MHz}$: $< -70\text{dBc}$ $> 10\text{MHz}$: $< -70\text{dBc} + 6\text{dB/ sound interval}$	
Phase noise	Typical (0dBm, 10kHz offset) 10MHz : $\leq -110\text{dBc/Hz}$	
Square		
Rise/fall time	$< 8\text{ns}$	
Jitter (rms), typical (1Vpp, 50 Ω)	$\leq 5\text{MHz}$: $2\text{ppm} + 300\text{ps}$ $> 5\text{MHz}$: 300ps	
Overshoot	Typical (100 kHz, 1 Vpp) $< 3\%$	
Duty cycle	50.00% (fixed)	
Ramp		
Linearity	$< 0.1\%$ of peak output (typical 1 kHz, 1 Vpp, symmetry 50%)	
Symmetry	0.0% to 100.0%	
Pulse		
Period	XDG2100 XDG2080 XDG2060	40 ns to 1000 ks
	XDG2035	66.667 ns to 1000 ks
Pulse Width	XDG2100 XDG2080 XDG2060	$\geq 12\text{ns}$
	XDG2035	$\geq 18\text{ns}$
Duty cycle	0.1% to 99.9% (limited by the frequency setting)	
Rise and fall time	$\geq 8\text{ns}$ (limited by the pulse width setting)	
Overshoot	$< 3\%$	
Jitter (rms), typical (1Vpp, 50 Ω)	$\leq 5\text{MHz}$: $2\text{ppm} + 300\text{ps}$ $> 5\text{MHz}$: 300ps	
Noise		
Types	Gaussian white noise	
Bandwidth (-3dB)	XDG2100	100 MHz BW
	XDG2080	80 MHz BW
	XDG2060	60 MHz BW
	XDG2035	35 MHz BW
Arbitrary wave		
Waveform length	2 to 10M points	
Sampling rate	500M Sa/s	
Amplitude accuracy	14 bits	
Minimum rise and fall time	$< 8\text{ns}$	
Jitter (rms), typical (1Vpp, 50 Ω)	$\leq 5\text{MHz}$: $2\text{ppm} + 300\text{ps}$ $> 5\text{MHz}$: 300ps	
Harmonic wave		
Harmonic number	≤ 16	
Harmonic type	Odd, even, sequential, custom	

8.Specification

Harmonic amplitude	Each harmonic amplitude can be set
Harmonic phase	Each harmonic phase can be set

Modulation Characteristics

Modulation Characteristics	
Modulation Type	AM, DSB-AM, FM, PM, ASK, FSK, PSK, BPSK, QPSK, 3FSK, 4FSK, OSK, PWM, SUM
AM	
Carrier	Sine wave, square wave, ramp wave, arbitrary wave (except DC)
Modulated signal source	Internal or external
Internal modulation waveform	Sine wave, square wave, ramp wave, white noise, arbitrary waveform
Internal amplitude modulation frequency	2 MHz to 1 MHz
Depth	0% to 120%
DSB-AM	
Carrier	Sine wave, square wave, ramp wave
Modulated signal source	Internal or external
Internal modulation waveform	Sine wave, square wave, ramp wave
Internal amplitude modulation frequency	2 MHz to 1 MHz
Depth	0% to 100%
FM	
Carrier	Sine wave, square wave, ramp wave, arbitrary wave (except DC)
Modulated signal source	Internal or external
Internal modulation waveform	Sine, square, ramp, white noise, and arbitrary waveforms
Internal modulation frequency	2 MHz to 1 MHz
Frequency offset	$2 \text{ MHz} \leq \text{offset} \leq \min(\text{carrier frequency}, \text{carrier maximum frequency} - \text{carrier frequency})$ by default, the smaller of the two
PM	
Carrier	Sine wave, square wave, ramp wave, arbitrary wave (except DC)
Modulated signal source	Internal or external
Internal modulation waveform	Sine, square, ramp, white noise, and arbitrary waveforms
Internal phase modulation frequency	2 MHz to 1 MHz
Phase deviation range	0° to 180°
PWM	
Carrier	Pulse wave
Modulated signal source	Internal or external

8.Specification

Internal modulation waveform	Sine, square, ramp, white noise, and arbitrary waveforms (except DC)
Internal phase modulation frequency	2 MHz to 1 MHz
Offset	0 to min (min is the smaller value of pulse wave duty cycle and 100%-pulse wave duty cycle)
ASK	
Carrier	Sine wave, square wave, ramp wave, arbitrary wave
Modulated signal source	Internal or external
Internal modulation waveform	50% square wave
ASK frequency	2 MHz to 1MHz
PSK	
Carrier	Sine wave, square wave, ramp wave, arbitrary wave
Modulated signal source	Internal or external
Internal modulation waveform	50% square wave
PSK frequency	2 MHz to 1MHz
FSK	
Carrier	Sine wave, square wave, ramp wave, arbitrary wave
Modulated signal source	Internal or external
Internal modulation waveform	50% square wave
FSK frequency	2 MHz to 1MHz
3FSK	
Carrier	Sine wave, square wave, ramp wave, arbitrary wave
Modulated signal source	Internal
Internal modulation waveform	50% square wave
FSK frequency	2 MHz to 1MHz
4FSK	
Carrier	Sine wave, square wave, ramp wave, arbitrary wave
Modulated signal source	Internal
Internal modulation waveform	50% square wave
FSK frequency	2 MHz to 1MHz
BPSK	
Carrier	Sine wave, square wave, ramp wave, arbitrary wave
Modulated signal source	Internal
Internal modulation waveform	50% square wave
BPSK frequency	2 MHz to 1MHz
QPSK	

8.Specification

Carrier	Sine wave, square wave, ramp wave, arbitrary wave
Modulated signal source	Internal
Internal modulation waveform	50% square wave
QPSK frequency	2 MHz to 1MHz
OSK	
Carrier	Sine wave
Modulated signal source	Internal
Internal modulation waveform	50% square wave
Oscillation time	8ns to 249.75μs
OSK frequency	2 MHz to 1MHz
SUM	
Carrier	Sine wave, square wave, ramp wave
Modulated signal source	Internal or external
Internal modulation waveform	Sine wave, square wave, ramp wave, white noise, arbitrary waveform
Internal amplitude modulation frequency	2 MHz to 1 MHz
Depth	0.0% to 100.0%

Sweep Characteristics

Sweep Characteristics			
Carrier	Sine, rectangular wave, ramp wave, arbitrary wave (Except DC)		
Minimum/maximum starting frequency	1μHz		
Maximum/Stop frequency	Sine wave	XDG2100	100MHz
		XDG2080	80MHz
		XDG2060	60MHz
		XDG2035	35MHz
	Square wave	XDG2100 XDG2080 XDG2060	30MHz
		XDG2035	15MHz
Ramp wave	3MHz		
Arbitrary wave	15MHz (built-in waveform) or 25MHz (user-defined waveform)		
Types	Linear, logarithmic, Step		
Sweep direction	Up / Down		
Sweep time	1 ms to 500 s ± 0.1%		
Trigger source	Internal, external, manual		

Burst Characteristics

Burst Characteristics	
Waveform	Sine wave, square wave, ramp wave, pulse wave, Noise wave (Except N Cycle) and arbitrary wave (Except DC)
Types	Count (1 to 100,000 cycles), unlimited, gated
Trigger source	Internal, external, manual
Carrier frequency	2mHz to BW/ 2
Trigger cycle	20ns - 500 s (Min = Cycles * Period)
Gated source	External trigger

Counter Specifications

Counter Specifications	
Measurement function	Frequency, period, positive pulse width, negative pulse width, duty cycle
Frequency Range	100 mHz - 200 MHz
Frequency resolution	7 digits
Coupling method	AC, DC
Voltage range and sensitivity (non-modulated signal)	
DC offset range	±1.5V
DC coupling	100mHz - 100 MHz: 250 mVpp - 5 Vpp (AC+DC) 100 Hz - 200 MHz: 400 mVpp - 5 Vpp (AC+DC)
AC coupling	1Hz - 100 MHz: 250 mVpp - 5 Vpp 100 Hz - 200 MHz: 400 mVpp - 5 Vpp
Pulse width and duty cycle measurement	1 Hz - 10 MHz (250 mVpp -5 Vpp)
Input resistance	1 MΩ
Sensitivity	Can be set high, medium and low
Trigger level range	±2.5 V

Input/Output Characteristics

Input/Output Characteristics	
Communication Interface	USB Host, USB Device, LAN, COM (Optional)
Channel coupling	Channel copy, amplitude syn, frequency syn, align phase
External modulation input	
Input frequency range	DC - 100 kHz
Input level range	± 1V full scale
Input impedance	10 kΩ (typical)
External trigger input	
Level	TTL-compatible
Slope	Rising or falling (selectable)
Pulse Width	>100ns

8.Specification

External clock input	
Impedance	1M Ω , AC coupling
Input level range	1Vpp to 3.3Vpp
Lock time	<1s
Lock range	10 MHz \pm 50Hz
Internal clock output	
Frequency	10 MHz \pm 50Hz
Impedance	50 Ω , DC coupling
Amplitude	1.2Vpp (50 Ω)
Sync Output	
Level	3.3V LVTTTL
Impedance	50 Ω , DC coupling
Maximum frequency	1MHz

General Specifications

Display	
Display type	7-inch color LCD display
Display resolution	800 Horizontal \times 480 Vertical pixels
Display color	65536 colors, 16 bits, TFT
Touch screen (Optional)	capacitive, multi-touch
Power	
Voltage	100 - 240 V (\pm 10%), 50 / 60 Hz
Power consumption	Less than 50VA
Fuse	250V, F2AL
Environment	
Temperature	Working temperature: 0 $^{\circ}$ C to 40 $^{\circ}$ C
	Storage temperature: -20 $^{\circ}$ C to 60 $^{\circ}$ C
Relative humidity	Less than 35 $^{\circ}$ C: \leq 90% relative humidity 35 $^{\circ}$ C to 40 $^{\circ}$ C: \leq 60% relative humidity
Height	Operating 3,000 meters Non-operation 12,000 meters
Cooling method	Smart fan cooling
Mechanical Specification	
Dimension	340 mm (Length) \times 177 mm (Height) \times 90mm (Width)
Weight	Approx. 2.3 kg
Others	
IP protection	IP2X
Adjustment interval	The recommended calibration interval is one year

9. Appendix

Appendix A: Accessories

- 1 × power cord that meets the standards of the country where you are located
- 1 × USB communication cable
- 1 × CD with communication software
- 1 × Quick Guide
- 2 × BNC/Q9 cable

Appendix B: General Care and Cleaning

General Maintenance

Do not store or leave the instrument where the liquid crystal display will be exposed to direct sunlight for long periods of time.

Caution: To avoid any damage to the instrument or probe, do not exposed it to any sprays, liquids, or solvents.

Cleaning

Inspect the instrument and probes as often as operating conditions require. To clean the instrument exterior, perform the following steps:

1. Wipe the dust from the instrument and probe surface with a soft cloth. Do not make any scuffing on the transparent LCD protection screen when clean the LCD screen.
2. Disconnect power before cleaning your instrument. Clean the instrument with a wet soft cloth not dripping water. It is recommended to scrub with soft detergent or fresh water. To avoid damage to the instrument or probe, do not use any corrosive chemical cleaning agent.

 **Warning:** Before power on again for operation, it is required to confirm that the instrument has already been dried completely, avoiding any electrical short circuit or bodily injury resulting from the moisture.

PC Software USB Driver Install Guide

Use the supplied USB cable to connect the oscilloscope with a PC through their USB ports.

Note: If you use a USB cable that is not supplied by us, some problems such as connection error and signal disturbing might occur.

Install Guide for Windows 10\Windows 8\Windows 7\Windows Vista

During the whole installation, please assure that the device is running well and plugged into PC from USB.

Right click [**Computer**], you can find it on the desktop, or in [**Start**] menu.



In the pop up menu, click [**Manage**] and it will open a window named "Computer Management", as follow, in the left side click [**Device Manager**], it will show a devices tree in the middle, and then click the last one button "Scan for hardware changes" in tool bar as follow, and if the device is running well and plugged into PC, computer will detect an unknown device with a "!" icon.

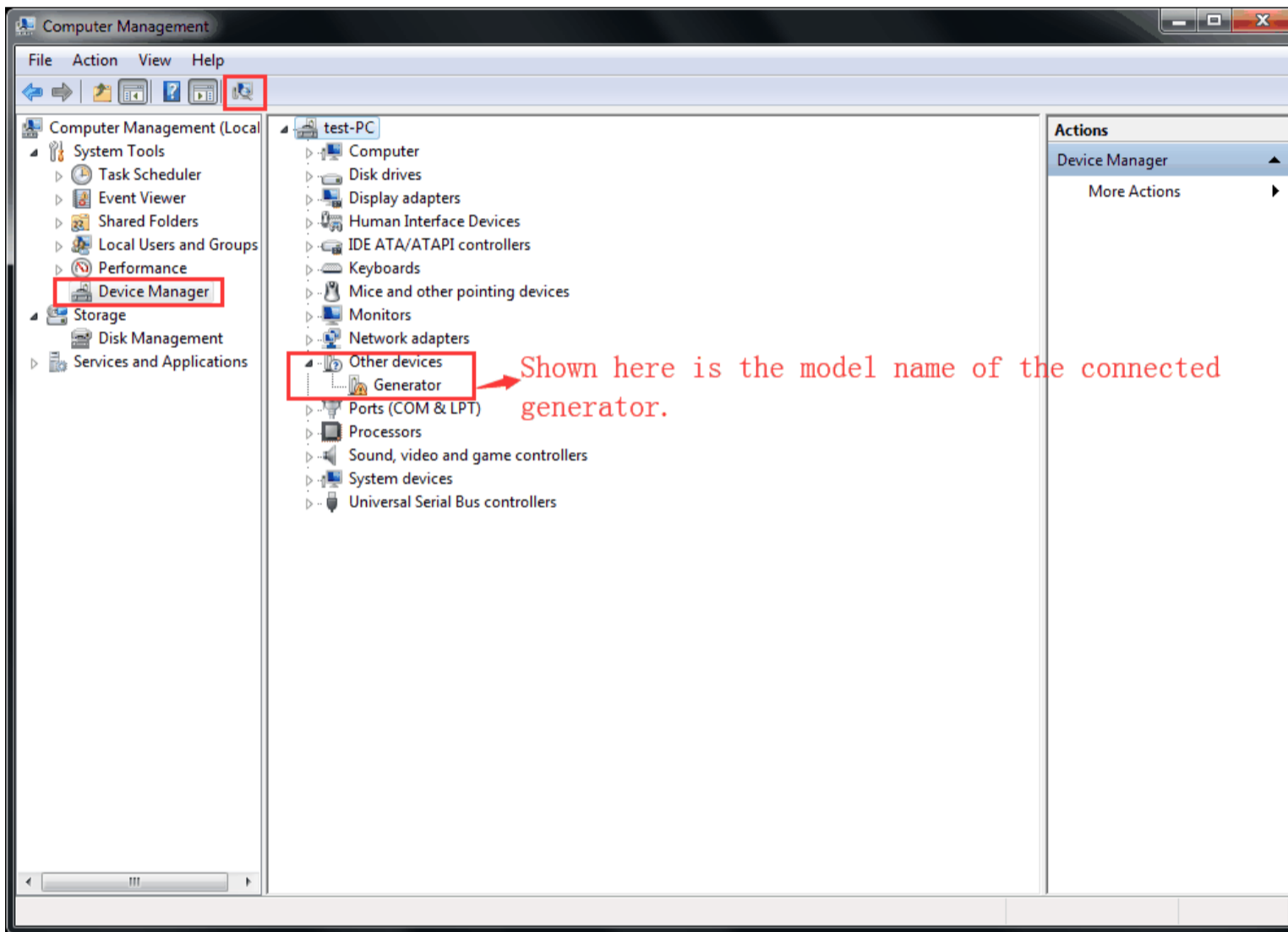

Right click the unknown device icon, in the pop up menu click [**Update Driver Software...**],

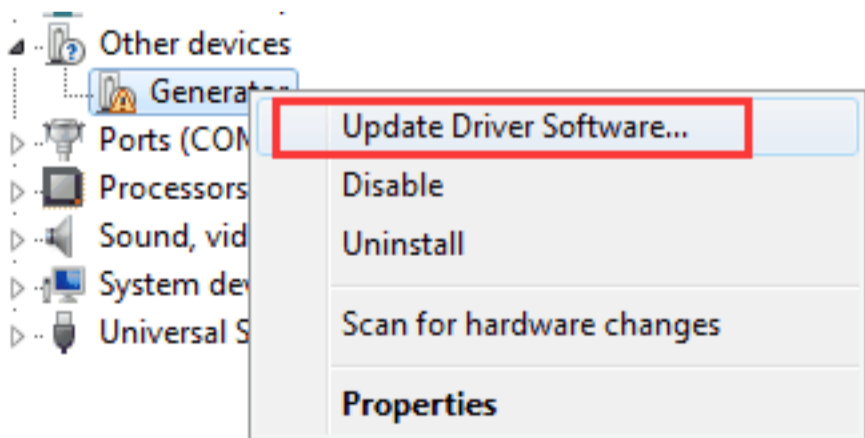

In the open window, select [**Browse my computer for driver software**].

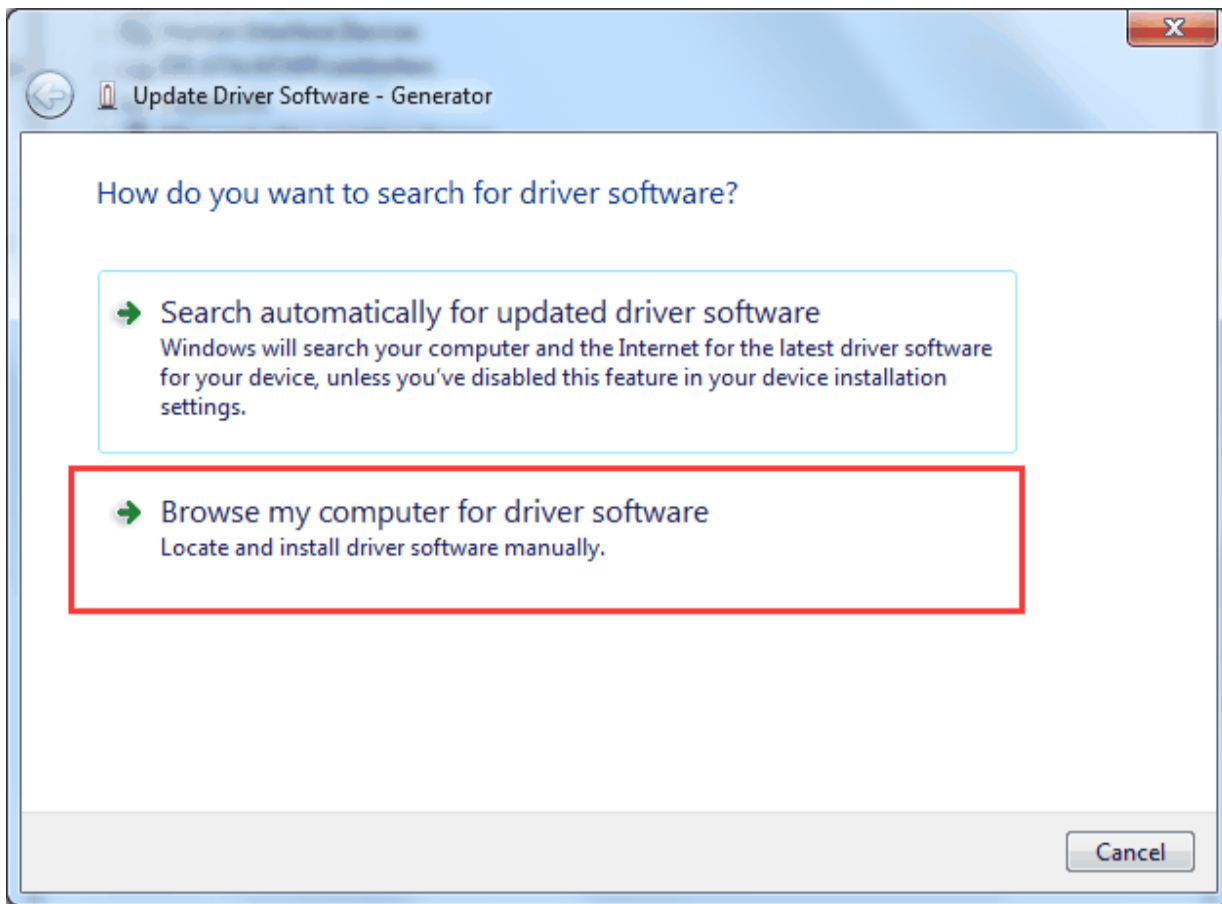

The next window, select a directory path for the driver software location "`USBDRV\win10_win8_win7_vista`", and click "**Next**".

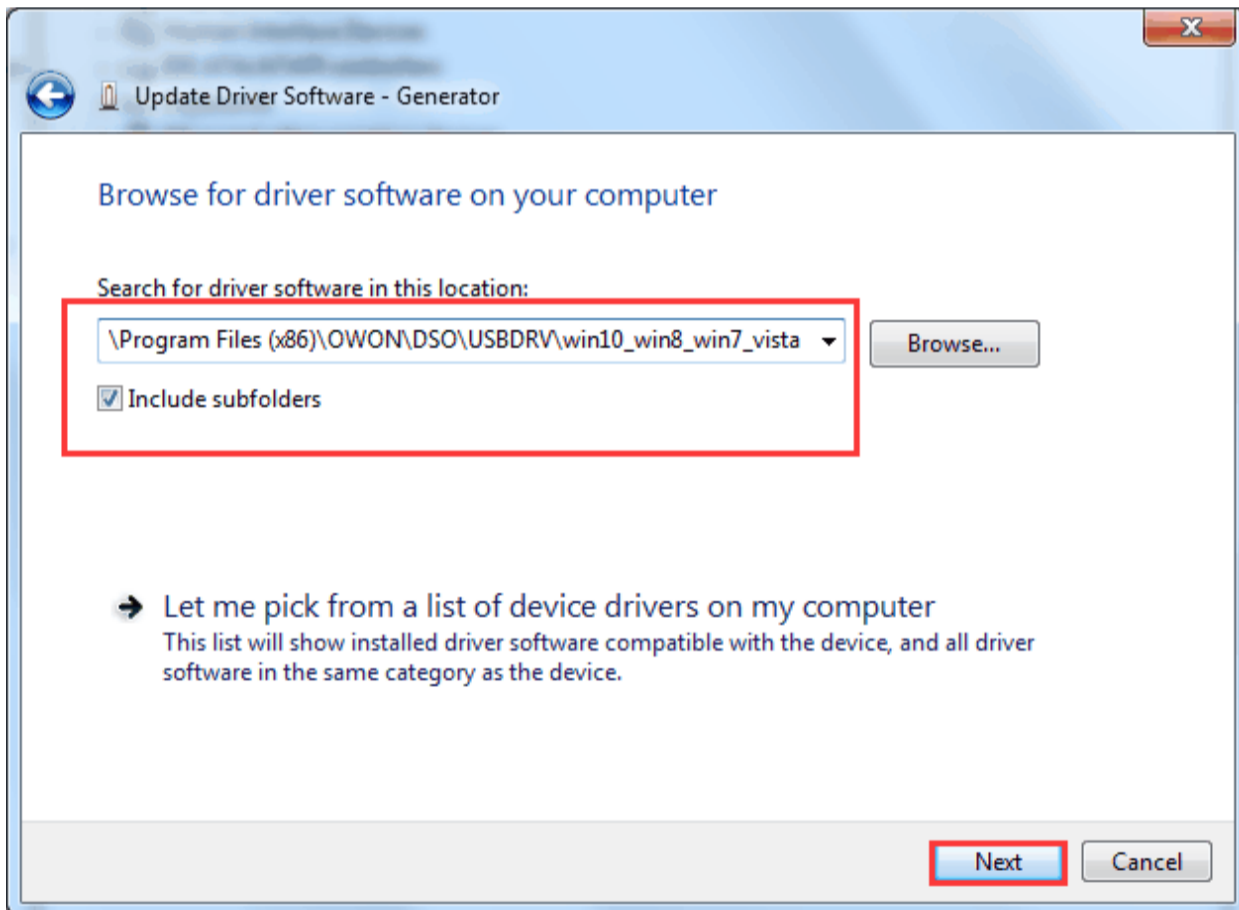

The system is installing driver software for you, as follow:

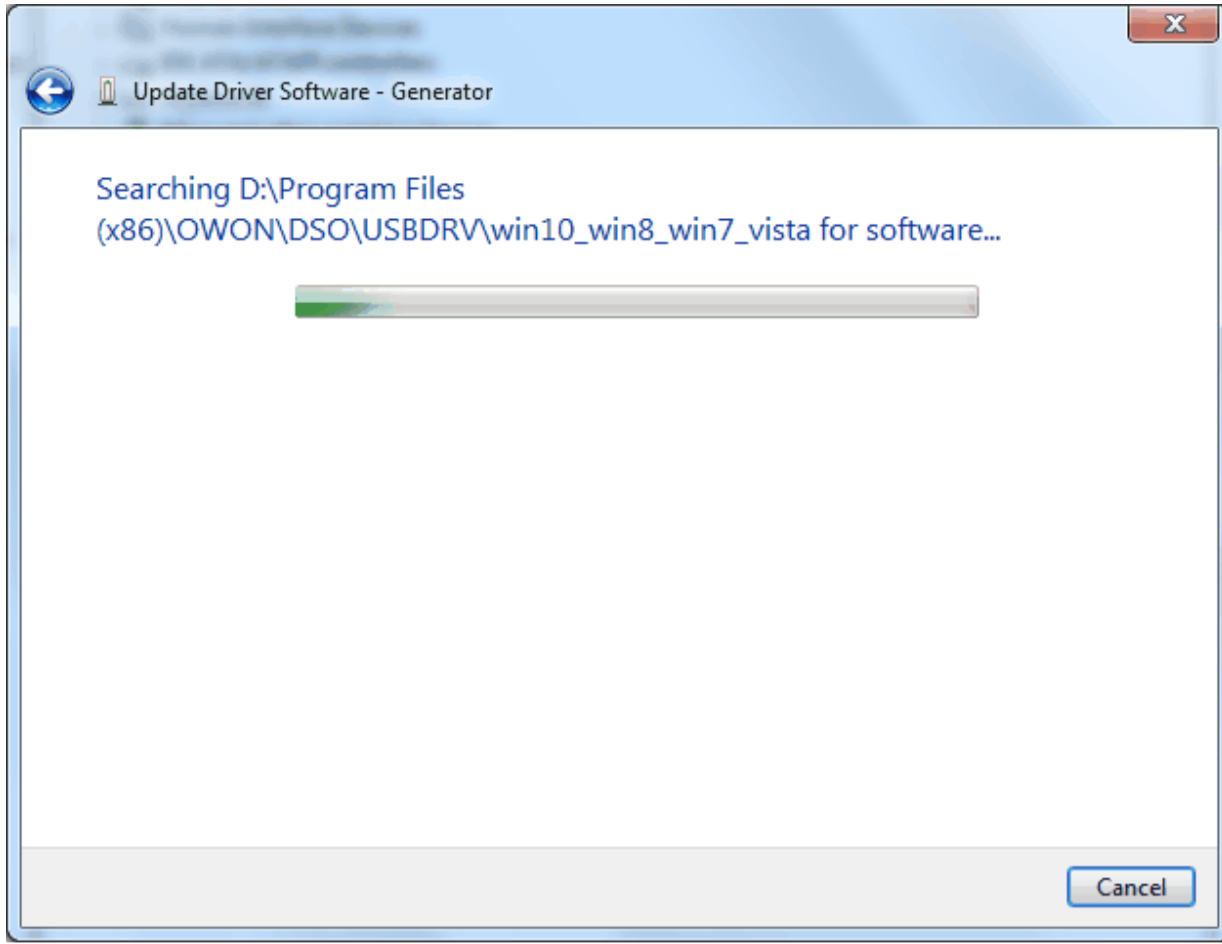

And finish.

Now a successful installation window opens with information "Windows has successfully updated your driver software".

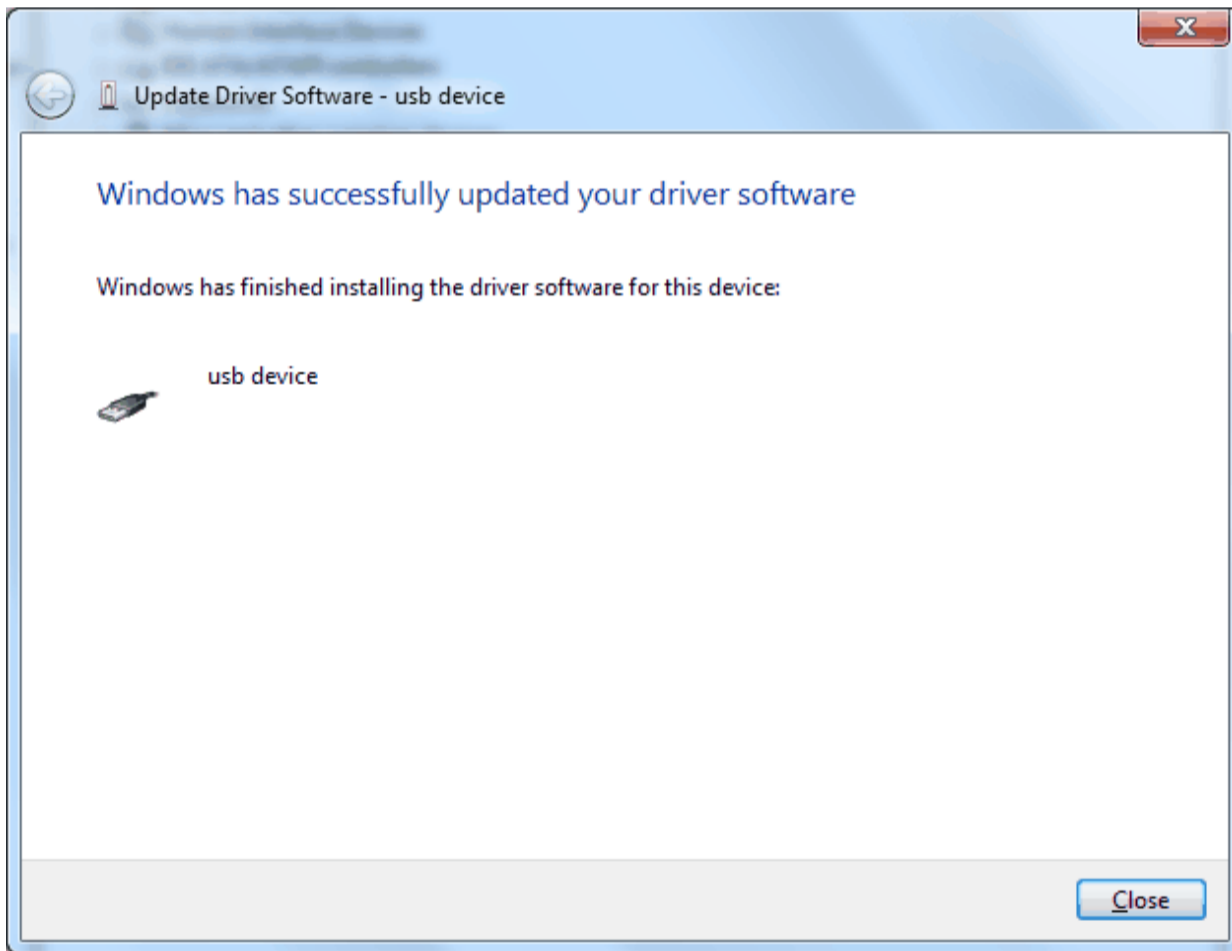

Close the window, have a look at the "Computer Management" window, you will find a device under [LibUSB-Win32 Devices], it should be like this:

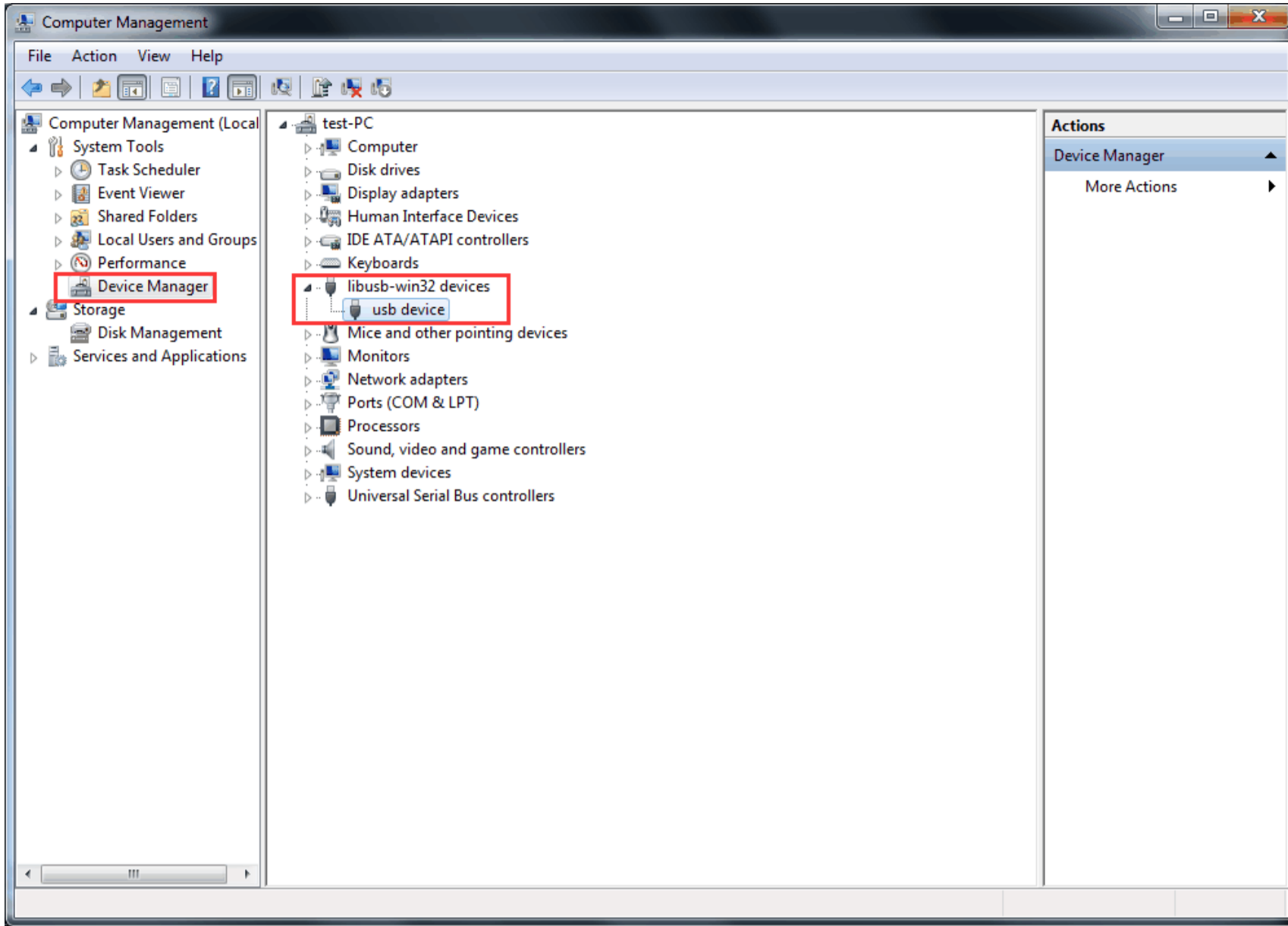

Now the USB driver will work.

Install Guide for Windows XP\Windows 2000

Notice: for both x86 and x64.

Plug into the running well device to open [Found New Hardware Wizard] dialog.



Or you can right click [My Computer] and select [Manage], in the left area of opened [Computer Management] select [Device Manager] , double click the item [USB Device] with "?" in the middle area to open the Wizard,

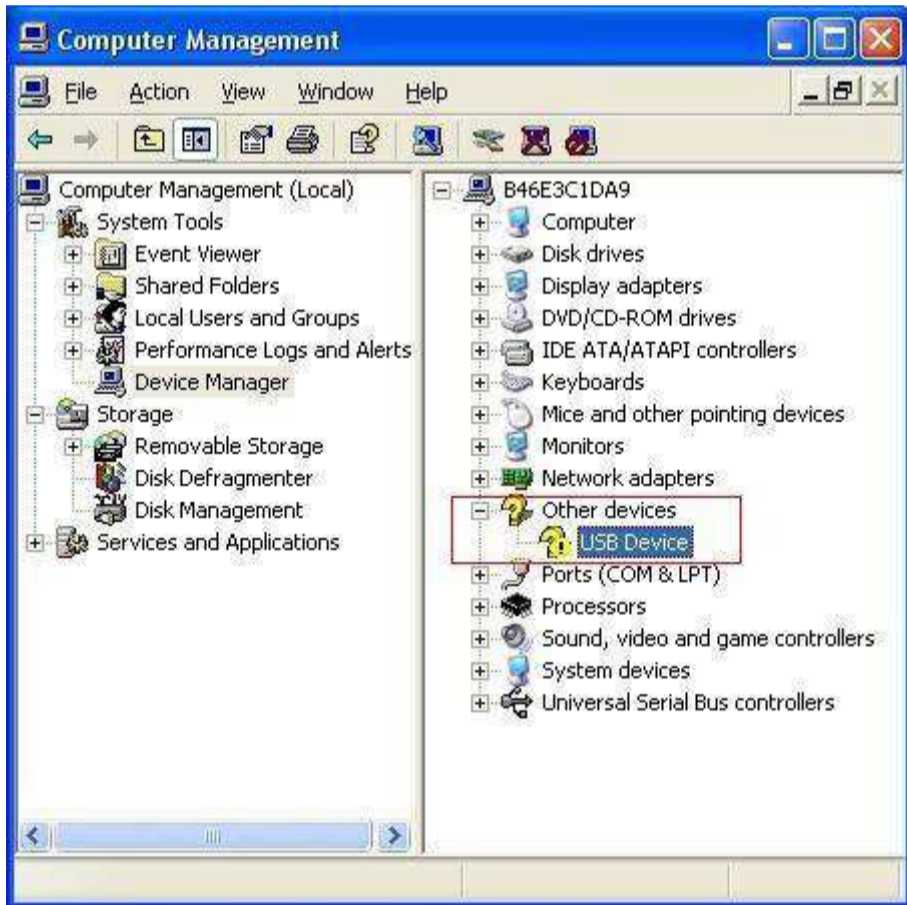

Select "Install from a list or specific location(Advanced)".



Select [Search for the best driver in these locations.] , then select [Include this location in the search] and indicate a directory location for USB driver which is named as "USBDRV\win_xp" and under the directory where you installed the program at,

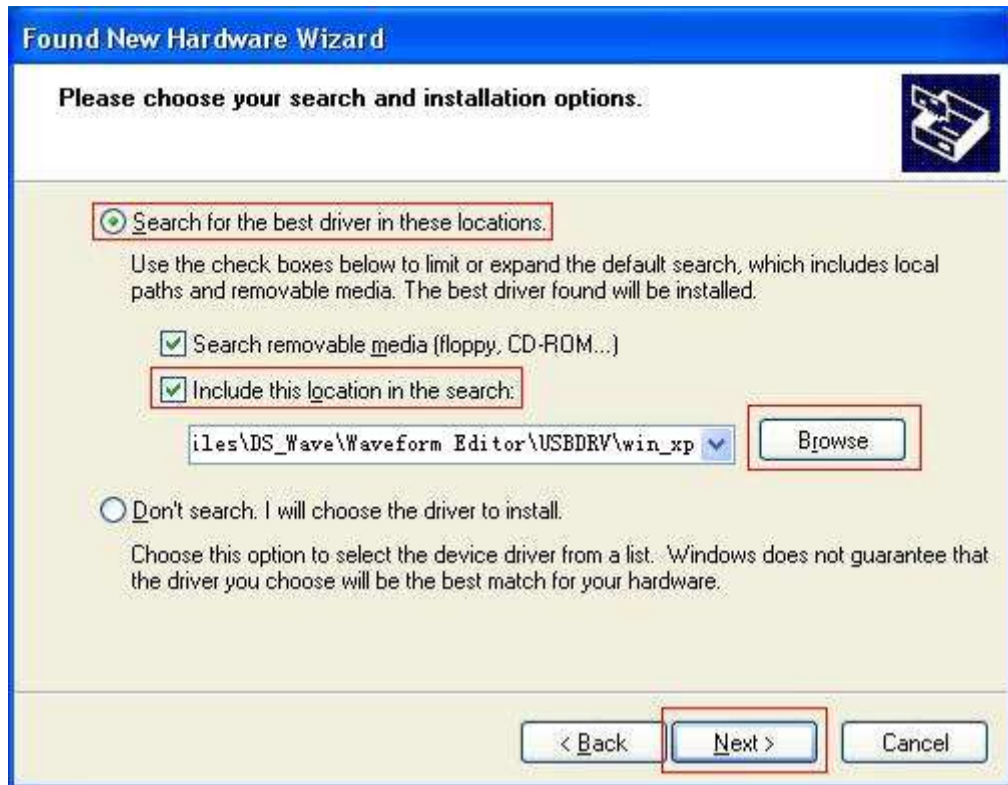

Then the installation is running,



And complete,



And prompt as installed,



And show installed in [Device Management],

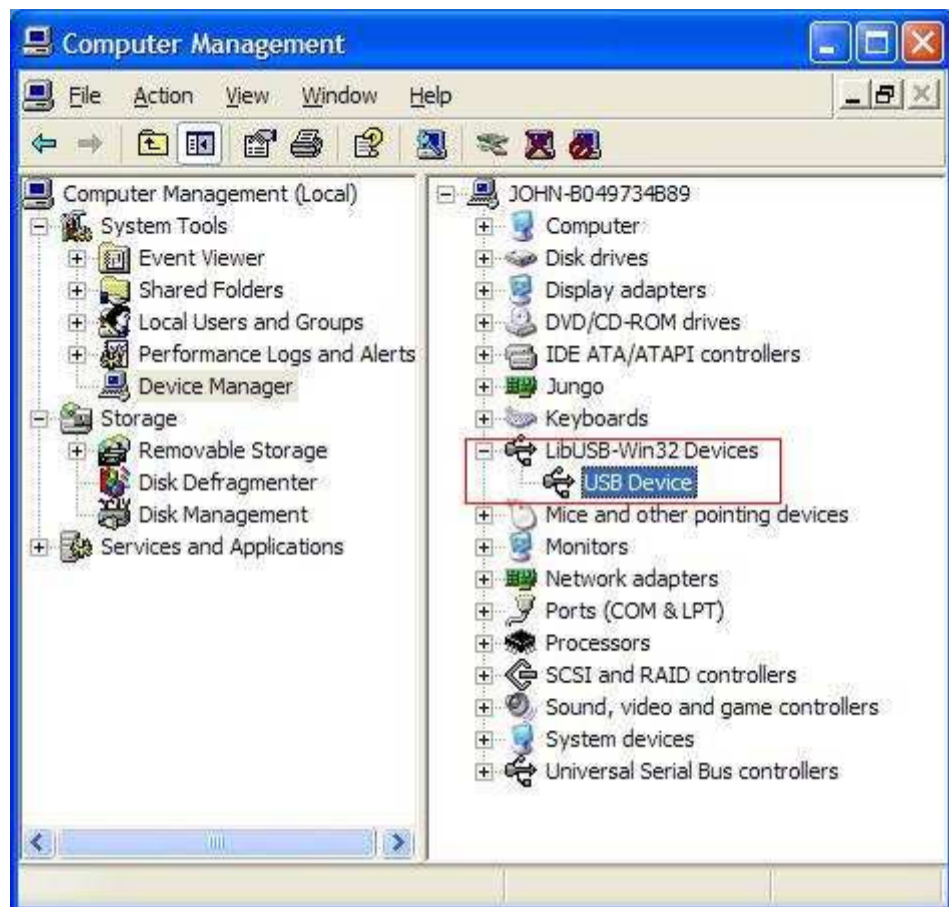

Now you can use the program and use it for USB communication.

If there is an early version of USB driver in your computer, you could try running "reinstall.bat" to fix, the file is under the directory of "USBDRV".

Mar. 2018 V1.4



**XDG Dual-Channel
Arbitrary Waveform Generator
Programmer Manual**

www.owon.com.cn

Representations and Warranties

Nov. 2018 edition V1.0.0

Copyright © LILLIPUT Company. All rights reserved.

The LILLIPUT's products are under the protection of the patent rights, including ones which have already obtained the patent rights and those which are applied for. The information in this manual will replace all materials published.

The information in this manual was correct at the time of printing. However, LILLIPUT will continue to improve products and reserves the rights to change specification at any time without notice.

owon[®] is the registered trademark of the LILLIPUT Company.

Fujian LILLIPUT Optoelectronics Technology Co., Ltd.

No. 19, Heming Road

Lantian Industrial Zone, Zhangzhou 363005 P.R. China

Tel: +86-596-2130430

Fax: +86-596-2109272

Web: www.owon.com.cn

E-mail: info@owon.com.cn

Table of Contents

Representations and Warranties	ii
1. Introduction to the SCPI Language.....	1
1.1. Command Syntax	1
1.2. Symbol Description	1
1.3. Programmed Parameter Type	1
1.4. Command Abbreviation	2
2. Commands	3
AFGControl:CSCopy (No Query Form).....	3
*CLS (No Query Form).....	3
COUNter:COUPing.....	3
COUNter:DUTYcycle? (Query Only).....	4
COUNter:FREQ? (Query Only).....	4
COUNter:HFR	5
COUNter:PERiod? (Query Only)	5
COUNter:PULSewidth? (Query Only)	6
COUNter:SENSitivity.....	6
COUNter:TRIGger	7
DISPlay:BRIGhtness	7
DISPlay:SAVer:DELay	8
DISPlay:SAVer:IMMEDIATE (No Query Form)	8
DISPlay:SAVer[:STATe].....	9
HCOPy:SDUMp:DATA? (Query Only)	9
HCOPy:SDUMp[:IMMEDIATE] (No Query Form)	10
*IDN? (Query Only)	10
MMEMory:CATalog? (Query Only).....	11
MMEMory:CDIRectory	11
MMEMory:DELete (No Query Form).....	12
OUTPut[1 2]:IMPedance	12
OUTPut[1 2][:STATe].....	13
*RCL (No Query Form)	13
*RST (No Query Form)	14
*SAV (No Query Form)	14
[SOURce[1 2]]:AM[:DEPTh]	15
[SOURce[1 2]]:AM:INTernal:FREQUency	15
[SOURce[1 2]]:AM:INTernal:FUNCTion	16
[SOURce[1 2]]:AM:INTernal:FUNCTion:EFILe.....	16
[SOURce[1 2]]:AM:SOURce	17
[SOURce[1 2]]:AM:STATe	17
[SOURce[1 2]]:ASKey[:AMPLitude].....	18

[SOURCE[1 2]]:ASKey:INTERNAL:RATE	19
[SOURCE[1 2]]:ASKey:SOURce	19
[SOURCE[1 2]]:ASKey:STATe	20
[SOURCE[1 2]]:BPSKey:DATA.....	20
[SOURCE[1 2]]:BPSKey:INTERNAL:RATE	21
[SOURCE[1 2]]:BPSKey:PHASe	21
[SOURCE[1 2]]:BPSKey:STATe	22
[SOURCE[1 2]]:BURSt:GATE:POLarity.....	22
[SOURCE[1 2]]:BURSt:INTERNAL:PERiod.....	23
[SOURCE[1 2]]:BURSt:MODE	23
[SOURCE[1 2]]:BURSt:NCYCles.....	24
[SOURCE[1 2]]:BURSt:SOURce	25
[SOURCE[1 2]]:BURSt:STATe.....	25
[SOURCE[1 2]]:FM[:DEViation]	26
[SOURCE[1 2]]:FM:INTERNAL:FREQuency.....	26
[SOURCE[1 2]]:FM:INTERNAL:FUNcTion.....	27
[SOURCE[1 2]]:FM:INTERNAL:FUNcTion:EFILe	27
[SOURCE[1 2]]:FM:SOURce.....	28
[SOURCE[1 2]]:FM:STATe.....	28
[SOURCE[1 2]]:FREQuency:CENTer	29
[SOURCE[1 2]]:FREQuency:CONcURRENT	30
[SOURCE[1 2]]:FREQuency[:FIXed]	30
[SOURCE[1 2]]:FREQuency:SPAN	31
[SOURCE[1 2]]:FREQuency:STARt	31
[SOURCE[1 2]]:FREQuency:STOP	32
[SOURCE[1 2]]:FSKey[:FREQuency]	33
[SOURCE[1 2]]:FSKey:INTERNAL:RATE.....	33
[SOURCE[1 2]]:FSKey:SOURce.....	34
[SOURCE[1 2]]:FSKey:STATe	34
[SOURCE[1 2]]:3FSKey[:FREQuency].....	35
[SOURCE[1 2]]:3FSKey:INTERNAL:RATE.....	35
[SOURCE[1 2]]:3FSKey:STATe	36
[SOURCE[1 2]]:4FSKey[:FREQuency].....	36
[SOURCE[1 2]]:4FSKey:INTERNAL:RATE.....	37
[SOURCE[1 2]]:4FSKey:STATe	38
[SOURCE[1 2]]:FUNcTion:EFILe.....	38
[SOURCE[1 2]]:FUNcTion:RAMP:SYMMetry	39
[SOURCE[1 2]]:FUNcTion[:SHAPe]	39
[SOURCE[1 2]]:HARMonic:AMPL	41
[SOURCE[1 2]]:HARMonic:ORDER	41
[SOURCE[1 2]]:HARMonic:PHASe	42
[SOURCE[1 2]]:HARMonic:TYPE.....	42
[SOURCE[1 2]]:MOD:STATe	43
[SOURCE[1 2]]:OSKey:INTERNAL:RATE	43

[SOURce[1 2]]:OSKey:STAtE.....	44
[SOURce[1 2]]:OSKey:TIME	45
[SOURce[1 2]]:PHASe[:ADJust]	45
[SOURce[1 2]]:PHASe:INITiate (No Query Form)	46
[SOURce[1 2]]:PM[:DEViation].....	46
[SOURce[1 2]]:PM:INTernal:FREQuency.....	47
[SOURce[1 2]]:PM:INTernal:FUNction	47
[SOURce[1 2]]:PM:INTernal:FUNction:EFILe.....	48
[SOURce[1 2]]:PM:SOURce	49
[SOURce[1 2]]:PM:STAtE	49
[SOURce[1 2]]:PSKey[:DEViation].....	50
[SOURce[1 2]]:PSKey:INTernal:RATE.....	50
[SOURce[1 2]]:PSKey:SOURce	51
[SOURce[1 2]]:PSKey:STAtE	51
[SOURce[1 2]]:PULSe:DCYCLe	52
[SOURce[1 2]]:PULSe:TRANSition[:LEADing]	52
[SOURce[1 2]]:PULSe:TRANSition:TRAILing.....	53
[SOURce[1 2]]:PULSe:WIDTh.....	53
[SOURce[1 2]]:PWM:INTernal:FREQuency	54
[SOURce[1 2]]:PWM:INTernal:FUNction.....	55
[SOURce[1 2]]:PWM:INTernal:FUNction:EFILe	55
[SOURce[1 2]]:PWM:SOURce	56
[SOURce[1 2]]:PWM:STAtE.....	56
[SOURce[1 2]]:PWM[:DEViation]:DCYCLe.....	57
[SOURce[1 2]]:SWEep:SOURce.....	57
[SOURce[1 2]]:SWEep:SPACing.....	58
[SOURce[1 2]]:SWEep:STAtE.....	58
[SOURce[1 2]]:SWEep:TIME	59
[SOURce[1 2]]:VOLTage[:LEVel][:IMMediate]:OFFSet	60
[SOURce[1 2]]:VOLTage[:LEVel][:IMMediate][:AMPLitude]	60
SYSTem:BEEPer[:IMMediate] (No Query Form)	61
SYSTem:BEEPer:STAtE.....	61
SYSTem:ERRor[:NEXT]? (Query Only)	62
SYSTem:KLOCK[:STAtE].....	62
SYSTem:LANguage.....	63
SYSTem:POWeron.....	63
SYSTem:RESTART	64
SYSTem:VERSion? (Query Only).....	64
TRACe DATA:CATalog? (Query Only).....	65
TRACe DATA:COpy (No Query Form)	65
TRACe DATA[:DATA]	66
TRACe DATA[:DATA]:VALue.....	66
TRACe DATA:POINts.....	67
*TRG (No Query Form).....	67

3. Command Errors	69
4. Index	70

1. Introduction to the SCPI Language

1.1. Command Syntax

The command systems present a hierarchy structure (tree system) and each command consists of a "Root" keyword and one or multiple sub-keywords. The keywords are separated by ":" and are followed by the parameter settings available, "?" is added at the end of the command string to indicate query and the command and parameter are separated by "space".

1.2. Symbol Description

Following symbols are usually used to assist to explain the parameters contained in a command.

a) Braces { }

The options enclosed in a { } are parameters available in the command. Only one option could be selected every time, and all the options are separated by "|". For example, {ON|OFF} indicates that ON or OFF can be selected.

b) Triangle Brackets < >

The parameter enclosed in < > must be replaced by an effective value.

1.3. Programmed Parameter Type

The commands contain 8 kinds of parameters, different parameters have different setting methods.

(1) **arbitrary block**

A specified length of arbitrary data, for example,

#6377512xxxxx . . . where

6 indicates that the following 6 digits (377512) specify the length of the data in bytes;

xxxxx ... indicates the data or #0xxxxx...<LF><&EOI>

(2) **boolean**

Boolean numbers or values, for example,

ON or \neq 0

OFF or 0

(3) **discrete**

A list of specific values, for example,

MIN, MAX

(4) **NR1** numeric

Integers, for example,
0, 2, 30, -5

(5) NR2 numeric

Decimal numbers, for example,
0.6, 3.1415926, -2.6

(6) NR3 numeric

Floating point numbers, for example,
3.1415E-7, -8.2E3

(7) NRf numeric

Flexible decimal number that may be type NR1, NR2 or NR3
See NR1, NR2, and NR3 examples

(8) string

Alphanumeric characters (must be within quotation marks)
"Model, 123456"

1.4. Command Abbreviation

All the commands are case-insensitive, so you can use any kind of them. But if abbreviation is used, all the capital letters specified in commands must be written completely. For example,
SOURce1:FREQuency:FIXed 500kHz also can be:
SOUR1:FREQ:FIX 500kHz

2. Commands

AFGControl:CSCopy (No Query Form)

This command copies setup parameters for one channel to another channel.

Syntax

AFGControl:CSCopy {CH1|CH2},{CH1|CH2}

Arguments

CH1|CH2

Examples

AFGControl:CSCopy CH1,CH2

copies the CH1 setup parameters into CH2.

***CLS (No Query Form)**

This command clears all the event registers and queues, which are used in the instrument status and event reporting system.

Syntax

*CLS

Arguments

None

Examples

*CLS

clears all the event registers and queues.

COUNter:COUPing

This command sets or queries the coupling mode of the counter to AC or DC.

Syntax

COUNter:COUPing [AC|DC]
COUNter:COUPing?

Arguments

AC means that AC is selected for the coupling mode of the counter.
DC means that DC is selected for the coupling mode of the counter.

Returns

AC|DC

Example

COUNter:COUPing DC
sets the coupling mode of the counter to DC.

COUNter:DUTYcycle? (Query Only)

This query-only command returns the measurement results for duty cycle of the counter.

Syntax

COUNter:DUTYcycle?

Arguments

None

Returns

<dutycycle>::=<NR3>

Examples

:COUNter:DUTYcycle?
might returns 2.265700368E+01.

COUNter:FREQ? (Query Only)

This query-only command returns the measurement results for frequency of the counter.

Syntax

COUNter:FREQ?

Arguments

None

Returns

<frequency>::=<NR3>

Examples

:COUNter:FREQ?

might returns 1.000082563E+02.

COUNter:HFR

This command enables or disables the high-frequency reject of the counter. The query returns the state of high-frequency reject of the counter.

Syntax

COUNter:HFR {ON|OFF|<NR1>}

COUNter:HFR?

Arguments

ON or <NR1>≠0 enables the high-frequency reject of the counter.

OFF or <NR1>=0 disables the high-frequency reject of the counter.

Returns

<NR1>

Examples

COUNter:HFR ON

enables the high-frequency reject of the counter.

COUNter:PERiod? (Query Only)

This query-only command returns the measurement results for period of the counter.

Syntax

COUNter:PERiod?

Arguments

None

Returns

<period>::=<NR3>

Examples

:COUNter:PERiod?

might returns 8.545000251E-03.

COUNter:PULSewidth? (Query Only)

This query-only command returns the measurement results for pulse width of the counter.

Syntax

COUNter:PULSewidth?

Arguments

None

Returns

<pulsewidth>::=<NR3>

Examples

:COUNter:PULSewidth?

might returns 366213017E-03.

COUNter:SENSitivity

This command sets or queries the trigger sensitivity of the counter.

Syntax

COUNter:SENSitivity [LOW|MIDDLE|HIGH]

COUNter:SENSitivity?

Arguments

LOW means that Low is selected for the trigger sensitivity of the counter.

MIDDLE means that Middle is selected for the trigger sensitivity of the counter.

HIGH means that High is selected for the trigger sensitivity of the counter.

Returns

LOW|MIDDLE|HIGH

Example

COUNter:SENSitivity LOW

sets the trigger sensitivity of the counter to Low.

COUNTER:TRIGGER

This command sets or queries the trigger level of the counter.

Syntax

COUNTER:TRIGGER {<value>|MINimum|MAXimum}

COUNTER:TRIGGER? {MINimum|MAXimum}

Arguments

<value>::=<NR3>[<units>]

where:

<NR3> is the trigger level of the counter.

<units>::=[mV|V]

Returns

<value>

Examples

COUNTER:TRIGGER 500mV

sets the trigger level of the counter to 500 mV.

DISPLAY:BRIGHTNESS

This command sets or queries the brightness of the LCD display.

Syntax

DISPLAY:BRIGHTNESS {<brightness>|MINimum|MAXimum}

DISPLAY:BRIGHTNESS?

Arguments

<brightness>::=<NR1>[<units>]

where:

<NR1> is a range of display brightness from 0 through 100. The larger the value, the higher the screen brightness.

<units>::=[PCT]

MINimum sets the display to the lowest brightness level.

MAXimum sets the display to the highest brightness level.

Returns

<NR1>

Examples

DISPLAY:BRIGHTNESS 90

sets the display brightness to 90%.

DISPlay:SAVer:DElay

This command sets or queries delay time for the screen saver function. The setting range is 1 minute to 999 minutes.

Syntax

DISPlay:SAVer:DElay {<minutes>|MINimum|MAXimum}

DISPlay:SAVer:DElay? {MINimum|MAXimum}

Arguments

<minutes>::=<NR1>[<units>]

where:

<NR1> is the delay time in minutes.

<units>::=MIN

Returns

<minutes>

Examples

DISPlay:SAVer:DElay 30

sets the delay time for the screen saver function to 30 minutes.

DISPlay:SAVer:IMMediate (No Query Form)

This command sets the screen saver state to ON, regardless of the DISPlay:SAVer[:STATe] command setting.

The screen saver is enabled immediately (without waiting for the delay time).

Syntax

DISPlay:SAVer:IMMediate

Arguments

None

Examples

DISPLAY:SAVER:IMMEDIATE

sets the screen saver state to ON.

DISPlay:SAVer[:STATe]

This command sets or queries the screen saver setting of the LCD display. When enabled, the screen saver function starts automatically if no operations are applied to the instrument front panel for the delay time set in DISPlay:SAVer:DELAy.

Syntax

DISPlay:SAVer[:STATe] {ON|OFF|<NR1>}

DISPlay:SAVer[:STATe]?

Arguments

ON or <NR1>≠0 enables the screen saver function.

OFF or <NR1>=0 disables the screen saver function.

Returns

<NR1>

indicating the screen saver state.

Examples

DISPLAY:SAVER:STATE OFF

disables the screen saver function.

HCOPy:SDUMp:DATA? (Query Only)

This query-only command returns a specified length of binary data which consist a BMP screen image.

Syntax

HCOPy:SDUMp:DATA?

Arguments

None

Returns

<data>::=<arbitrary block>

Examples

HCOPY:SDUMP:DATA?

might return the following response:

#6377512xxxxx . . . where

6 indicates that the following 6 digits (377512) specify the length of the data in bytes;

xxxxx ... indicates the BMP image data.

HCOPY:SDUMP[:IMMEDIATE] (No Query Form)

This command copies a screen image and saves the image file to a USB memory. The default file name is n.BMP, where n is a consecutive number from 0. The image files are saved in a folder named Model/IMAGE (Model is the instrument model) in the USB memory.

Syntax

HCOPY:SDUMP[:IMMEDIATE]

Arguments

None

Examples

HCOPY:SDUMP:IMMEDIATE

copies the screen image and may create a file 1.BMP in a USB memory.

***IDN? (Query Only)**

This query-only command returns identification information on the instrument.

Syntax

*IDN?

Arguments

None

Returns

<Manufacturer>,<Model>,<Serial Number>,<Firmware Level>

Examples

*IDN?

might return the following response:
OWON,XDG3202,1837001,SCPI:99.0 FV:V1.2.0

MMEMory:CATalog? (Query Only)

This query-only command returns the current state of the mass storage system (USB memory).

Syntax

MMEMory:CATalog?

Arguments

None

Returns

<NR1>,<NR1>[,<file_name>,<file_type>,<file_size>]...

where:

The first <NR1> indicates that the total amount of storage currently used, in bytes. The second <NR1> indicates that the free space of mass storage, in bytes.

<file_name> is the name of directory or file. If the name exceeds 22 characters in length, it will be shortened to 8 characters (without suffix) in 8.3 name format.

<file_type> is DIR for directory, otherwise it is blank.

<file_size> is the size of the file, in bytes. This value will be 0 for directory.

Examples

The USB memory includes the Test_folder folder, a Firmware.upp file, and a memo.txt file.

MMEMory:CATalog? might return the following response:

```
21973685,16851047,"Test_folder,DIR,0","Firmware.upp,,7791","memo.txt,,2566"
```

MMEMory:CDIRectory

This command changes the current working directory in the mass storage system.

Syntax

MMEMory:CDIRectory [<directory_name>]

MMEMory:CDIRectory?

Arguments

<directory_name>::=<string> indicates the current working directory for the mass storage

system.

Returns

<directory_name>::=<string>

Examples

MMEemory:CDIRectory "/Test_folder/Case"
changes the current directory to /Test_folder/Case.

MMEemory:DELeTe (No Query Form)

This command deletes a file or directory from the mass storage system. If a specified file in the mass storage is not allowed to overwrite or delete, this command causes an error. You can delete a directory if it is empty.

Syntax

MMEemory:DELeTe <file_name>

Arguments

<file_name>::=<string> specifies a file to be deleted and should include full path.

Examples

MMEemory:DELeTe "/Test_folder/Case/Firmware.upp"
deletes the Firmware.upp file from the /Test_folder/Case directory.

OUTPut[1|2]:IMPedance

This command sets the output load impedance for the specified channel. The specified value is used for amplitude, offset, and high/low level settings. You can set the impedance to any value from 1 Ω to 10 k Ω with a resolution of 1 Ω . The default value is 50 Ω . The query returns the current load impedance setting in ohms. If the load impedance is set to INFINITY, the query returns "9.9E+37".

Syntax

OUTPut[1|2]:IMPedance {<ohms>|INFINITY|MINimum|MAXimum}
OUTPut[1|2]:IMPedance? {MINimum|MAXimum}

Arguments

<ohms>::=<NR3>[<units>]

where:

<units>::=OHM

INFINITY sets the load impedance to >10 kΩ.

MINimum sets the load impedance to 1 Ω.

MAXimum sets the load impedance to 10 kΩ.

Returns

<ohms>::=<NR3>

Examples

OUTPut1:IMPedance MAXimum

sets the CH1 load impedance to 10 kΩ.

OUTPut[1|2][:STATe]

This command sets or query the instrument output state for the specified channel.

Syntax

OUTPut[1|2][:STATe] {ON|OFF|<NR1>}

OUTPut[1|2][:STATe]?

Arguments

ON or <NR1>≠0 enables the instrument output.

OFF or <NR1>=0 disables the instrument output.

Returns

<NR1>

Examples

OUTPut1:STATe ON

sets the instrument CH1 output to ON.

*RCL (No Query Form)

This command restores the state of the instrument from a copy of the settings stored in the setup memory. The settings are stored using the *SAV command. If the specified setup memory is deleted, this command causes an error.

Syntax

*RCL {0|1|2|...|14|15}

Arguments

0, 1, 2, ... 14, or 15 specifies the location of setup memory.

Examples

*RCL 3

restores the instrument from a copy of the settings stored in memory location 3.

***RST (No Query Form)**

This command resets the instrument to the factory default settings.

Syntax

*RST

Arguments

None

Examples

*RST

resets the instrument settings to the factory defaults.

***SAV (No Query Form)**

This command stores the current settings of the arbitrary function generator to a specified setup memory location.

Syntax

*SAV {0|1|2|...|14|15}

Arguments

0, 1, 2, ... 14, or 15 specifies the location of setup memory.

Examples

*SAV 3

saves the current instrument state in the memory location 3.

[SOURce[1|2]]:AM[:DEPTh]

This command sets or queries the modulation depth of AM modulation for the specified channel. Set the modulation depth from 0% to 100% with resolution of 1%.

Syntax

```
[SOURce[1|2]]:AM[:DEPTh] {<depth>|MINimum|MAXimum}  
[SOURce[1|2]]:AM[:DEPTh]? [MINimum|MAXimum]
```

Arguments

<depth>::=<NR2>[<units>]

where:

<NR2> is the depth of modulating frequency.

<units>::=PCT

MINimum sets the modulation depth to minimum value. MAXimum sets the modulation depth to maximum value.

Returns

<depth>

Examples

```
SOURce1:AM:DEPTh MAXimum
```

sets the depth of modulating signal on CH1 to the maximum value.

[SOURce[1|2]]:AM:INTernal:FREQuency

This command sets or queries the internal modulation frequency of AM modulation for the specified channel. Use this command when the internal modulation source is selected. Set the internal modulation frequency from 2 mHz to 100.00 kHz with resolution of 1 mHz.

Syntax

```
[SOURce[1|2]]:AM:INTernal:FREQuency {<frequency>|MINimum|MAXimum}  
[SOURce[1|2]]:AM:INTernal:FREQuency? [MINimum|MAXimum]
```

Arguments

<frequency>::=<NRf>[<units>]

where:

<NRf> is the modulation frequency.

<units>::=[Hz|kHz|MHz]

Returns

<frequency>

Examples

SOURce1:AM:INTernal:FREQuency 10kHz
sets the CH1 internal modulation frequency to 10 kHz.

[SOURce[1|2]]:AM:INTernal:FUNCTion

This command sets or queries the modulating waveform of AM modulation for the specified channel. Use this command when the internal modulation source is selected. If you specify EFILE when there is no EFILE or the EFILE is not yet defined, this command causes an error.

Syntax

```
[SOURce[1|2]]:AM:INTernal:FUNCTion {SINusoid|SQUare|RAMP|PRNoise  
|USER<NR1>|EMEMory|EFILE}  
[SOURce[1|2]]:AM:INTernal:FUNCTion?
```

Arguments

USER<NR1>|EMEMory

<NR1> specifies the user waveform memory location, can be any number from 0 to 15. A user defined waveform saved in the user waveform memory or the EMEMory can be selected as a modulating signal.

EFILE

EFILE is used as a modulating signal.

Returns

SIN|SQU|RAMP|PRN|USER<NR1>|EMEMory|EFILE

Examples

SOURce1:AM:INTernal:FUNCTion SQUare
selects Square as the shape of modulating waveform for the CH1 output.

[SOURce[1|2]]:AM:INTernal:FUNCTion:EFILE

This command sets or queries an EFILE name used as a modulating waveform for AM modulation. A file name must be specified in the mass storage system. This command returns " " if there is no file in the mass storage.

Syntax

[SOURce[1|2]]:AM:INTernal:FUNCTion:EFILe <file_name>
[SOURce[1|2]]:AM:INTernal:FUNCTion:EFILe?

Arguments

<file_name>::=<string> specifies a file name in the mass storage system. The <file_name> includes path. Path separators are forward slashes (/).

Returns

<file_name>

Examples

SOURce1:AM:INTernal:FUNCTion:EFILe "TEST"
sets a file named "TEST" in the mass storage.

[SOURce[1|2]]:AM:SOURce

This command sets or queries the source of modulating signal of AM modulation for the specified channel.

Syntax

[SOURce[1|2]]:AM:SOURce [INTernal|EXTernal]
[SOURce[1|2]]:AM:SOURce?

Arguments

INTernal means that the carrier waveform is modulated with an internal source.
EXTernal means that the carrier waveform is modulated with an external source.

Returns

INT|EXT

Examples

SOURce1:AM:SOURce INTernal
sets the CH1 source of modulating signal to internal.

[SOURce[1|2]]:AM:STATe

This command enables or disables AM modulation for the specified channel. The query returns the state of AM modulation.

Syntax

[SOURce[1|2]]:AM:STATe {ON|OFF|<NR1>}
[SOURce[1|2]]:AM:STATe?

Arguments

If [SOURce[1|2]] are omitted, CH1 is specified automatically.

ON or <NR1>≠0 enables AM modulation.

OFF or <NR1>=0 disables AM modulation.

Returns

<NR1>

Examples

SOURce1:AM:STATe ON

enables the CH1 AM modulation.

[SOURce[1|2]]:ASKey[:AMPLitude]

This command sets or queries the modulation amplitude of ASK modulation for the specified channel. Set the modulation amplitude from 0 Vpp to the current amplitude of the carrier waveform. The amplitude resolution is 1 mVpp or four digits.

Syntax

[SOURce[1|2]]:ASKey[:AMPLitude] {<amplitude>|MINimum|MAXimum}

[SOURce[1|2]]:ASKey[:AMPLitude]? [MINimum|MAXimum]

Arguments

<amplitude>::=<NRf>[<units>]

where:

<NRf> is the modulation amplitude.

<units>::=[mVpp|Vpp]

MINimum sets the modulation amplitude to minimum value.

MAXimum sets the modulation amplitude to maximum value.

Returns

<amplitude>

Examples

SOURce1:ASKey:AMPLitude MAXimum

sets the amplitude of modulating signal on CH1 to the maximum value.

[SOURce[1|2]]:ASKey:INTernal:RATE

This command sets or queries the internal modulation rate of ASK modulation for the specified channel. Use this command when the internal modulation source is selected.

Syntax

```
[SOURce[1|2]]:ASKey:INTernal:RATE {<rate>|MINimum|MAXimum}  
[SOURce[1|2]]:ASKey:INTernal:RATE? {MINimum|MAXimum}
```

Arguments

<rate>::=<NRf>[<units>]

where:

<NRf> is the modulation rate.

<units>::=[Hz|kHz|MHz]

Returns

<rate>

Examples

```
SOURce1:ASKey:INTernal:RATE 50Hz  
sets the CH1 internal modulation rate to 50 Hz.
```

[SOURce[1|2]]:ASKey:SOURce

This command sets or queries the source of modulation signal of ASK modulation for the specified channel.

Syntax

```
[SOURce[1|2]]:ASKey:SOURce [INTernal|EXTernal]  
[SOURce[1|2]]:ASKey:SOURce?
```

Arguments

INTernal means that the carrier waveform is modulated with an internal source.

EXTernal means that the carrier waveform is modulated with an external source.

Returns

INT|EXT

Examples

```
SOURce1:ASKey:SOURce INTernal  
sets the CH1 source of modulating signal to internal.
```

[SOURce[1|2]]:ASKey:STATe

This command enables or disables ASK modulation. The query returns the state of ASK modulation. Select a sine, square, ramp, or arbitrary waveform as the carrier waveform.

Syntax

```
[SOURce[1|2]]:ASKey:STATe {ON|OFF|<NR1>}  
[SOURce[1|2]]:ASKey:STATe?
```

Arguments

ON or <NR1>≠0 enables ASK modulation.
OFF or <NR1>=0 disables ASK modulation.

Returns

<NR1>

Examples

```
SOURce1:ASKey:STATe ON  
enables the CH1 ASK modulation.
```

[SOURce[1|2]]:BPSKey:DATA

This command sets or queries the data source of modulation signal of BPSK modulation for the specified channel.

Syntax

```
[SOURce[1|2]]:BPSKey:DATA [01|10|PN15|PN21]  
[SOURce[1|2]]:BPSKey:DATA?
```

Arguments

01 means that the carrier waveform is modulated with 01 pattern.
10 means that the carrier waveform is modulated with 10 pattern.
PN15 means that the carrier waveform is modulated with PN15 pattern.
PN21 means that the carrier waveform is modulated with PN21 pattern.

Returns

01|10|PN15|PN21

Examples

SOURce1:BPSKey:DATA 01

sets the CH1 source of BPSK modulating signal to 01 pattern.

[SOURce[1|2]]:BPSKey:INTernal:RATE

This command sets or queries the internal modulation rate of BPSK modulation for the specified channel.

Syntax

[SOURce[1|2]]:BPSKey:INTernal:RATE {<rate>|MINimum|MAXimum}

[SOURce[1|2]]:BPSKey:INTernal:RATE? {MINimum|MAXimum}

Arguments

<rate>::=<NRf>[<units>]

where:

<NRf> is the modulation rate.

<units>::=[Hz|kHz|MHz]

Returns

<rate>

Examples

SOURce1:BPSKey:INTernal:RATE 50Hz

sets the CH1 internal BPSK modulation rate to 50 Hz.

[SOURce[1|2]]:BPSKey:PHASe

This command sets or queries the phase deviation of BPSK modulation for the specified channel.

Syntax

[SOURce[1|2]]:BPSKey:PHASe {<phase>|MINimum|MAXimum}

[SOURce[1|2]]:BPSKey:PHASe? [MINimum|MAXimum]

Arguments

<phase>::=<NR3>[<units>]

where:

<NR3> is the phase deviation.

<units>::=[RAD|DEG]

If <units> are omitted, RAD is specified automatically. The setting ranges are:

RAD: 0 PI to +1 PI, relative to phase value
DEG: 0 to +180, in 1 degree steps, relative to phase value

Returns

<phase>

Examples

SOURce1:BPSKey:PHASe MAXimum
sets the maximum value for the CH1 phase deviation of BPSK modulation.

[SOURce[1|2]]:BPSKey:STATe

This command enables or disables BPSK modulation. The query returns the state of BPSK modulation. Select a sine, square, ramp, or arbitrary waveform as the carrier waveform.

Syntax

[SOURce[1|2]]:BPSKey:STATe {ON|OFF|<NR1>}
[SOURce[1|2]]:BPSKey:STATe?

Arguments

ON or <NR1>≠0 enables BPSK modulation.
OFF or <NR1>=0 disables BPSK modulation.

Returns

<NR1>

Examples

SOURce1:BPSKey:STATe ON
enables the CH1 BPSK modulation.

[SOURce[1|2]]:BURSt:GATE:POLarity

This command sets the generator to output a burst when the gated signal at the [Ext Trig/Burst/Fsk In] connector at the rear panel is high level or low level. This command is only available in gated Burst mode.

Syntax

[SOURce[1|2]]:BURSt:GATE:POLarity{NORMal|INVerted}
[SOURce[1|2]]:BURSt:GATE:POLarity?

Arguments

NORMAL sets the polarity to Normal.

INVERTed sets the polarity to Inverted.

Returns

NORM|INV

Examples

SOURCE1:BURSt:GATE:POLarity INVERTed

sets the polarity to INVERTed, means the instrument outputs a burst when the gated signal at the [Ext Trig/Burst/Fsk In] connector at the rear panel is low level.

[SOURCE[1|2]]:BURSt:INTernal:PERiod

This command sets or queries the Burst period for the specified channel.

Syntax

[SOURCE[1|2]]:BURSt:INTernal:PERiod {<period>|MINimum|MAXimum}

[SOURCE[1|2]]:BURSt:INTernal:PERiod?[MINimum|MAXimum]

Arguments

<period>::=<NRf>[<units>]

where

<NRf> is the Burst period.

<units>::=[ns|us|ms|s]

Returns

<period>

Examples

SOURCE1:BURSt:INTernal:PERiod 200ns

sets the CH1 Burst period to 200 ns.

[SOURCE[1|2]]:BURSt:MODE

This command sets or queries the burst mode for the specified channel.

Syntax

[SOURCE[1|2]]:BURSt:MODE {TRIGgered|GATed}

[SOURce[1|2]]:BURSt:MODE?

Arguments

TRIGgered means that triggered mode is selected for burst mode.

GATed means that gated mode is selected for burst mode.

Returns

TRIG|GAT

Examples

SOURce1:BURSt:MODE TRIGgered

selects triggered mode.

[SOURce[1|2]]:BURSt:NCYCles

This command sets or queries the number of cycles (burst count) to be output in burst mode for the specified channel. The query returns 9.9E+37 if the burst count is set to INFINITY.

Syntax

[SOURce[1|2]]:BURSt:NCYCles {<cycles>|INFINITY|MINimum|MAXimum}

[SOURce[1|2]]:BURSt:NCYCles? {MINimum|MAXimum}

Arguments

<cycles>::=<NRf>

where:

<NRf> is the burst count. The burst count ranges from 1 to 500,000.

INFINITY sets the burst count to infinite count.

MINimum sets the burst count to minimum count.

MAXimum sets the burst count to maximum count.

Returns

<cycles>

Examples

SOURce1:BURSt:NCYCles 2

sets the CH1 burst count to 2.

[SOURce[1|2]]:BURSt:SOURce

This command sets or queries the trigger source in the burst mode for the specified channel. This command is available only in the Triggered burst mode.

Syntax

```
[SOURce[1|2]]:BURSt:SOURce [TImer|MANual|EXternal]  
[SOURce[1|2]]:BURSt:SOURce?
```

Arguments

TImer specifies an internal clock as the trigger source.

MANual specifies a manual trigger input as the trigger source.

EXternal specifies an external trigger input as the trigger source.

Returns

TIM|MAN|EXT

Examples

```
SOURce1:BURSt:SOURce EXternal
```

sets an external trigger input as the trigger source in the burst mode.

[SOURce[1|2]]:BURSt:STATe

This command enables or disables the burst mode for the specified channel. The query returns the state of burst mode.

Syntax

```
[SOURce[1|2]]:BURSt:STATe {ON|OFF|<NR1>}  
[SOURce[1|2]]:BURSt:STATe?
```

Arguments

ON or <NR1>≠0 enables the burst mode.

OFF or <NR1>=0 disables the burst mode.

Returns

<NR1>

Examples

```
SOURce1:BURSt:STATe ON
```

enables the burst mode for the CH1.

[SOURce[1|2]]:FM[:DEVIation]

This command sets or queries the peak frequency deviation of FM modulation for the specified channel. The setting range of frequency deviation depends on the waveform selected as the carrier.

Syntax

```
[SOURce[1|2]]:FM[:DEVIation] {<deviation>|MINimum|MAXimum}  
[SOURce[1|2]]:FM[:DEVIation]? [MINimum|MAXimum]
```

Arguments

<deviation>::=<NRf>[<units>]

where:

<NRf> is the frequency deviation.

<units>::=[Hz|kHz|MHz]

Returns

<deviation>

Examples

```
SOURce1:FM:DEVIation 1.0MHz
```

sets the CH1 frequency deviation to 1.0 MHz.

[SOURce[1|2]]:FM:INTernal:FREQUENCY

This command sets or queries the internal modulation frequency of FM modulation for the specified channel. Use this command when the internal modulation source is selected.

Set the internal modulation frequency from 2 mHz to 100.00 kHz with resolution of 1 mHz.

Syntax

```
[SOURce[1|2]]:FM:INTernal:FREQUENCY {<frequency>|MINimum|MAXimum}  
[SOURce[1|2]]:FM:INTernal:FREQUENCY? [MINimum|MAXimum]
```

Arguments

<frequency>::=<NRf>[<units>]

where:

<NRf> is the modulation frequency.

<units>::=[Hz|kHz|MHz]

Returns

<frequency>

Examples

SOURce1:FM:INTernal:FREQuency 10kHz
sets the CH1 internal modulation frequency to 10 kHz.

[SOURce[1|2]]:FM:INTernal:FUNCTion

This command sets or queries the modulating waveform of FM modulation for the specified channel. Use this command when the internal modulation source is selected. If you specify EFILe when there is no EFILe or the EFILe is not yet defined, this command causes an error.

Syntax

[SOURce[1|2]]:FM:INTernal:FUNCTion {SINusoid|SQUare|RAMP|PRNoise
|USER<NR1>|EMEMory|EFILe}
[SOURce[1|2]]:FM:INTernal:FUNCTion?

Arguments

USER<NR1>|EMEMory

<NR1> specifies the user waveform memory location, can be any number from 0 to 15.

A user defined waveform saved in the user waveform memory or the EMEMory can be selected as a modulating signal.

EFILe

EFILe is used as a modulating signal.

Returns

SIN|SQU|RAMP|PRN|USER<NR1>|EMEMory|EFILe

Examples

SOURce1:FM:INTernal:FUNCTion SQUare
selects Square as the shape of modulating waveform for the CH1 output.

[SOURce[1|2]]:FM:INTernal:FUNCTion:EFILe

This command sets or queries an EFILe name used as a modulating waveform for FM modulation. A file name must be specified in the mass storage system. This command returns " " if there is no file in the mass storage.

Syntax

[SOURce[1|2]]:FM:INTernal:FUNCTion:EFILe <file_name>
[SOURce[1|2]]:FM:INTernal:FUNCTion:EFILe?

Arguments

<file_name>::=<string> specifies a file name in the mass storage system. The <file_name> includes path. Path separators are forward slashes (/).

Returns

<file_name>

Examples

SOURce1:FM:INTernal:FUNCTion:EFILe "TEST"
sets a file named "TEST" in the mass storage.

[SOURce[1|2]]:FM:SOURce

This command sets or queries the source of modulating signal of FM modulation for the specified channel.

Syntax

[SOURce[1|2]]:FM:SOURce [INTernal|EXTernal]
[SOURce[1|2]]:FM:SOURce?

Arguments

INTernal means that the carrier waveform is modulated with the internal source.
EXTernal means that the carrier waveform is modulated with an external source.

Returns

INT|EXT

Examples

SOURce1:FM:SOURce INTernal
sets the CH1 source of modulating signal to internal.

[SOURce[1|2]]:FM:STATe

This command enables or disables FM modulation. The query returns the state of FM modulation.

Syntax

[SOURce[1|2]]:FM:STATe {ON|OFF|<NR1>}
[SOURce[1|2]]:FM:STATe?

Arguments

ON or <NR1>≠0 enables FM modulation.
OFF or <NR1>=0 disables FM modulation.

Returns

<NR1>

Examples

SOURce1:FM:STATe ON
enables the CH1 FM modulation.

[SOURce[1|2]]:FREQuency:CENTer

This command sets or queries the center frequency of sweep for the specified channel. This command is always used with the [SOURce[1|2]]:FREQuency:SPAN command. The setting range of center frequency depends on the waveform selected for sweep.

Syntax

[SOURce[1|2]]:FREQuency:CENTer {<frequency>|MINimum|MAXimum}
[SOURce[1|2]]:FREQuency:CENTer? {MINimum|MAXimum}

Arguments

<frequency>::=<NRf>[<units>]

where:

<NRf> is the center frequency.

<units>::=[Hz|kHz|MHz]

Returns

<frequency>

Examples

SOURce1:FREQuency:CENTer 550kHz
sets the CH1 center frequency to 550 kHz.

[SOURce[1|2]]:FREQUency:CONCurent

This command enables or disables the function to copy the frequency (or period) of one channel to another channel.

The[SOURce[1|2]]:FREQUency:CONCurent command copies the frequency (or period) of the channel specified by the header suffix to another channel. If you specify CH1 with the header, the CH1 frequency will be copied to CH2.

When the concurrent copy function is enabled, the FreqLock function is also enabled automatically. Use general knob to adjust frequency (or period) of the two channels synchronously.

The[SOURce[1|2]]:FREQUency:CONCurent? command returns "0" (off) or "1" (on).

Syntax

```
[SOURce[1|2]]:FREQUency:CONCurent {ON|OFF|<NR1>}  
[SOURce[1|2]]:FREQUency:CONCurent?
```

Arguments

ON or <NR1>≠0 enables the concurrent copy function.
OFF or <NR1>=0 disables the concurrent copy function.

Returns

<NR1>

Examples

```
SOURce1:FREQUency:CONCurent ON  
copies the frequency value of CH1 to CH2.
```

[SOURce[1|2]]:FREQUency[:FIXed]

This command sets or queries the frequency of output waveform for the specified channel. The setting range of output frequency depends on the type of output waveform. If you change the type of output waveform, it might change the output frequency because changing waveform types impacts on the setting range of output frequency. The resolution is 1 μHz or 12 digits.

Syntax

```
[SOURce[1|2]]:FREQUency[:FIXed] {<frequency>|MINimum|MAXimum}  
[SOURce[1|2]]:FREQUency[:FIXed]? {MINimum|MAXimum}
```

Arguments

<frequency>::=<NRf>[<units>]

where:

<NRf> is the output frequency.

<units>::=[Hz|kHz|MHz]

Returns

<frequency>

Examples

SOURce1:FREQuency:FIXed 500kHz
sets the CH1 output frequency to 500 kHz.

[SOURce[1|2]]:FREQuency:SPAN

This command sets or queries the span of frequency sweep for the specified channel. This command is always used with the [SOURce[1|2]]:FREQuency:CENTer command. The setting range of frequency span depends on the waveform selected for sweep.

Syntax

[SOURce[1|2]]:FREQuency:SPAN {<frequency>|MINimum|MAXimum}

[SOURce[1|2]]:FREQuency:SPAN? {MINimum|MAXimum}

Arguments

<frequency>::=<NRf>[<units>]

where:

<NRf> is the frequency span.

<units>::=[Hz|kHz|MHz]

Returns

<frequency>

Examples

SOURce1:FREQuency:SPAN 900 kHz
sets the CH1 frequency span to 900 kHz.

[SOURce[1|2]]:FREQuency:START

This command sets or queries the start frequency of sweep for the specified channel. This

command is always used with the [SOURce[1|2]]:FREQUENCY:STOP command. The setting range of start frequency depends on the waveform selected for sweep.

Syntax

```
[SOURce[1|2]]:FREQUENCY:START {<frequency>|MINimum|MAXimum}  
[SOURce[1|2]]:FREQUENCY:START? {MINimum|MAXimum}
```

Arguments

<frequency>::=<NRf>[<units>]

where:

<NRf> is the start frequency.

<units>::=[Hz|kHz|MHz]

Returns

<frequency>

Examples

```
SOURce1:FREQUENCY:START 10kHz
```

sets the sweep start frequency of CH1 to 10 kHz.

[SOURce[1|2]]:FREQUENCY:STOP

This command sets or queries the stop frequency of sweep for the specified channel. This command is always used with the [SOURce[1|2]]:FREQUENCY:START command. The setting range of stop frequency depends on the waveform selected for sweep.

Syntax

```
[SOURce[1|2]]:FREQUENCY:STOP {<frequency>|MINimum|MAXimum}  
[SOURce[1|2]]:FREQUENCY:STOP? {MINimum|MAXimum}
```

Arguments

<frequency>::=<NRf>[<units>]

where:

<NRf> is the stop frequency.

<units>::=[Hz|kHz|MHz]

Returns

<frequency>

Examples

```
SOURce1:FREQUENCY:STOP 100kHz
```

sets the stop frequency of CH1 to 100 kHz.

[SOURce[1|2]]:FSKey:FREQUENCY

This command sets or queries the hop frequency of FSK modulation for the specified channel.

Syntax

```
[SOURce[1|2]]:FSKey:FREQUENCY {<frequency>|MINimum|MAXimum}  
[SOURce[1|2]]:FSKey:FREQUENCY? {MINimum|MAXimum}
```

Arguments

<frequency>::=<NRf>[<units>]

where:

<NRf> is the hop frequency.

<units>::=[Hz|kHz|MHz]

Returns

<frequency>

Examples

```
SOURce1:FSKey:FREQUENCY 1.0MHz
```

sets the hop frequency of CH1 FSK modulation to 1.0 MHz.

[SOURce[1|2]]:FSKey:INTERNAL:RATE

This command sets or queries the internal modulation rate of FSK modulation for the specified channel. Use this command when the internal modulation source is selected.

Syntax

```
[SOURce[1|2]]:FSKey:INTERNAL:RATE {<rate>|MINimum|MAXimum}  
[SOURce[1|2]]:FSKey:INTERNAL:RATE? {MINimum|MAXimum}
```

Arguments

<rate>::=<NRf>[<units>]

where:

<NRf> is the modulation rate.

<units>::=[Hz|kHz|MHz]

Returns

<rate>

Examples

SOURce1:FSKey:INTernal:RATE 50Hz

sets the CH1 internal FSK modulation rate to 50 Hz.

[SOURce[1|2]]:FSKey:SOURce

This command sets or queries the source of modulation signal of FSK modulation for the specified channel.

Syntax

[SOURce[1|2]]:FSKey:SOURce [INTernal|EXTernal]

[SOURce[1|2]]:FSKey:SOURce?

Arguments

INTernal means that the carrier waveform is modulated with an internal source.

EXTernal means that the carrier waveform is modulated with an external source.

Returns

INT|EXT

Examples

SOURce1:FSKey:SOURce INTernal

sets the CH1 source of modulating signal to internal.

[SOURce[1|2]]:FSKey:STATE

This command enables or disables FSK modulation. The query returns the state of FSK modulation. Select a sine, square, ramp, or arbitrary waveform as the carrier waveform.

Syntax

[SOURce[1|2]]:FSKey:STATE {ON|OFF|<NR1>}

[SOURce[1|2]]:FSKey:STATE?

Arguments

ON or <NR1>≠0 enables FSK modulation.

OFF or <NR1>=0 disables FSK modulation.

Returns

<NR1>

Examples

SOURce1:FSKey:STATe ON
enables the CH1 FSK modulation.

[SOURce[1|2]]:3FSKey[:FREQUENCY]

This command sets or queries the hop frequency of 3FSK modulation for the specified channel.

Syntax

[SOURce[1|2]]:3FSKey[:FREQUENCY] <n>,{<frequency>|MINimum|MAXimum}
[SOURce[1|2]]:3FSKey[:FREQUENCY]? <n>,{MINimum|MAXimum}

Arguments

<n>::=<NR1>

where:

<NR1> is the sequence number of hop frequency, which can be 1 or 2.

<frequency>::=<NRf>[<units>]

where:

<NRf> is the hop frequency.

<units>::=[Hz|kHz|MHz]

Returns

<frequency>

Examples

SOURce1:3FSKey:FREQUENCY 2,1.0MHz
sets the hop frequency 2 of CH1 3FSK modulation to 1.0 MHz.

[SOURce[1|2]]:3FSKey:INTERNAL:RATE

This command sets or queries the internal modulation rate of 3FSK modulation for the specified channel.

Syntax

[SOURce[1|2]]:3FSKey:INTERNAL:RATE {<rate>|MINimum|MAXimum}
[SOURce[1|2]]:3FSKey:INTERNAL:RATE? {MINimum|MAXimum}

Arguments

<rate>::=<NRf>[<units>]

where:

<NRf> is the modulation rate.

<units>::=[Hz|kHz|MHz]

Returns

<rate>

Examples

SOURce1:3FSKey:INTernal:RATE 50Hz

sets the CH1 internal 3FSK modulation rate to 50 Hz.

[SOURce[1|2]]:3FSKey:STATe

This command enables or disables 3FSK modulation. The query returns the state of 3FSK modulation. Select a sine, square, ramp, or arbitrary waveform as the carrier waveform.

Syntax

[SOURce[1|2]]:3FSKey:STATe {ON|OFF|<NR1>}

[SOURce[1|2]]:3FSKey:STATe?

Arguments

ON or <NR1>≠0 enables 3FSK modulation.

OFF or <NR1>=0 disables 3FSK modulation.

Returns

<NR1>

Examples

SOURce1:3FSKey:STATe ON

enables the CH1 3FSK modulation.

[SOURce[1|2]]:4FSKey[:FREQuency]

This command sets or queries the hop frequency of 4FSK modulation for the specified channel.

Syntax

[SOURce[1|2]]:4FSKey[:FREQuency] <n>,{<frequency>|MINimum|MAXimum}

[SOURce[1|2]]:4FSKey[:FREQuency]? <n>,{MINimum|MAXimum}

Arguments

<n>::=<NR1>

where:

<NR1> is the sequence number of hop frequency, which can be 1, 2, or 3.

<frequency>::=<NRf>[<units>]

where:

<NRf> is the hop frequency.

<units>::=[Hz|kHz|MHz]

Returns

<frequency>

Examples

SOURce1:4FSKey:FREQuency 2,1.0MHz

sets the hop frequency 2 of CH1 4FSK modulation to 1.0 MHz.

[SOURce[1|2]]:4FSKey:INTernal:RATE

This command sets or queries the internal modulation rate of 4FSK modulation for the specified channel.

Syntax

[SOURce[1|2]]:4FSKey:INTernal:RATE {<rate>|MINimum|MAXimum}

[SOURce[1|2]]:4FSKey:INTernal:RATE? {MINimum|MAXimum}

Arguments

<rate>::=<NRf>[<units>]

where:

<NRf> is the modulation rate.

<units>::=[Hz|kHz|MHz]

Returns

<rate>

Examples

SOURce1:4FSKey:INTernal:RATE 50Hz

sets the CH1 internal 4FSK modulation rate to 50 Hz.

[SOURce[1|2]]:4FSKey:STATe

This command enables or disables 4FSK modulation. The query returns the state of 4FSK modulation. Select a sine, square, ramp, or arbitrary waveform as the carrier waveform.

Syntax

```
[SOURce[1|2]]:4FSKey:STATe {ON|OFF|<NR1>}  
[SOURce[1|2]]:4FSKey:STATe?
```

Arguments

ON or <NR1>≠0 enables 4FSK modulation.
OFF or <NR1>=0 disables 4FSK modulation.

Returns

<NR1>

Examples

```
SOURce1:4FSKey:STATe ON  
enables the CH1 4FSK modulation.
```

[SOURce[1|2]]:FUNCTion:EFILe

This command sets or queries an EFILe name used as an output waveform. A file name must be specified in the mass storage system. This command returns “ ” if there is no file in the mass storage.

Syntax

```
[SOURce[1|2]]:FUNCTion:EFILe <file_name>  
[SOURce[1|2]]:FUNCTion:EFILe?
```

Arguments

<file_name>::=<string> specifies a file name in the mass storage system. The <file_name> includes path. Path separators are forward slashes (/).
NOTE: The <file_name> argument is case sensitive.

Returns

<file_name>

Examples

```
SOURce1:FUNCTion:EFILe "TEST"  
sets a file named "TEST" in the mass storage.
```

[SOURce[1|2]]:FUNCTION:RAMP:SYMMetry

This command sets or queries the symmetry of ramp waveform for the specified channel. The setting range is 0.0% to 100.0%.

Syntax

```
[SOURce[1|2]]:FUNCTION:RAMP:SYMMetry {<symmetry>|MINimum|MAXimum}  
[SOURce[1|2]]:FUNCTION:RAMP:SYMMetry?
```

Arguments

<symmetry>::=<NR2>[<units>]

where:

<NR2> is the symmetry.

<units>::=PCT

Returns

<symmetry>

Examples

```
SOURce1:FUNCTION:RAMP:SYMMetry 80.5  
sets the symmetry of the CH1 ramp waveform to 80.5%.
```

[SOURce[1|2]]:FUNCTION[:SHAPE]

This command sets or queries the shape of the output waveform. When the specified user memory is deleted, this command causes an error if you select the user memory.

Syntax

```
[SOURce[1|2]]:FUNCTION[:SHAPE] {SINusoid|SQUare|PULSe|RAMP  
|PRNoise|<Built_in>|USER<NR1>|EMEMory|EFILe}  
[SOURce[1|2]]:FUNCTION[:SHAPE]?
```

Arguments

<Built_in>::={DC|AbsSine|AbsSineHalf|AmpALT|AttALT|GaussPulse|NegRamp|NPulse|PPulse|SineTra|SineVer|StairDn|StairUD|StairUp|Trapezia|Heart|Cardiac|LFPulse|Tens1|Tens2|Tens3|EOG|EEG|Pulseilogram|ResSpeed|Ignition|TP2A|ISP|VR|TP1|TP2B|P4|TP5A|TP5B|SCR|Surge|Airy|Besselj|Bessely|Cauchy|X^3|Erf|Erfc|ErfcInv|ErfInv|Dirichlet|ExpFall|ExpRise|Laguerre|Laplace|Legend|Gauss|HaverSine|Log|LogNormal|Lorentz|Maxwell|Rayleigh|Versiera|Weibull|Ln(x)|X^2|Round|Chirp|Rhombus|CosH|Cot|CotH|CotHCon|CotHPro|CscCon|Csc|

CscPro|CscH|CscHCon|CscHPro|RecipCon|RecipPro|SecCon|SecPro|SecH|Sinc|SinH|Sqrt|Tan|TanH|ACos|ACosH|ACot|ACotCon|ACotPro|ACotH|ACotHCon|ACotHPro|Acsc|ACscCon|ACscPro|AcscH|ACscHCon|ACscHPro|Asec|AsecCon|AsecPro|AsecH|ASin|ASinH|ATan|ATanH|Bartlett|BarthannWin|Blackman|BlackmanH|BohmanWin|Boxcar|ChebWin|FlatTopWin|Hamming|Hanning|Kaiser|NuttallWin|ParzenWin|TaylorWin|Triang|TukeyWin|Butterworth|Combin|CPulse|CWPulse|RoundHalf|BandLimited|BlaseiWave|Chebyshev1|Chebyshev2|DampedOsc|DualTone|Gamma|GateVibar|LFMPulse|MCNoise|Discharge|Quake|Radar|Ripple|RoundsPM|StepResp|SwingOsc|TV|Voice|AM|FM|PM|PWM}

NOTE: The arguments defined in <Built_in> can not be abbreviated, all the upper and lower case letters are needed.

This command selects the output waveform of the instrument when Mod, Sweep and Burst are disabled.

This command selects the carrier waveform corresponding to the function when Mod, Sweep or Burst is currently enabled.

If you specify EFILE when there is no EFILE or the EFILE is not yet defined, this command causes an error.

If you change the type of output waveform, it might change the output frequency because changing waveform types impacts the setting range of output frequency.

USER<NR1>|EMEMory

<NR1> specifies the user waveform memory location, can be any number from 0 to 31.

A user defined waveform saved in the user waveform memory or the EMEMory can be selected as an output waveform.

EFILE

EFILE is specified as an output waveform.

Returns

SIN|SQU|PULS|RAMP|PRN|<Built_in>|USER<NR1>|EMEMory|EFILE

Examples

SOURce1:FUNCtion:SHAPE SQUare

selects the shape of CH1 output waveform to square waveform.

[SOURce[1|2]]:HARMonic:AMPL

This command sets or queries the amplitude of the specified order of harmonic.

Syntax

```
[SOURce[1|2]]:HARMonic:AMPL <sn>,<amplitude>|MINimum|MAXimum  
[SOURce[1|2]]:HARMonic:AMPL? <sn>[,MINimum|MAXimum]
```

Arguments

<sn>::=<NR1>

where:

<NR1> is the specified order of harmonic (2 to 16).

<amplitude>::=<NR3>[<units>]

where:

<NR3> is the output amplitude.

<units>::=[mVpp|Vpp]

Returns

<amplitude>

Example

```
:HARMonic:AMPL 2,2.5
```

sets the amplitude of the second order of harmonic to 2.5 Vpp.

```
:HARMonic:AMPL? 2
```

returns 2.500000E+00.

[SOURce[1|2]]:HARMonic:ORDER

This command sets or queries the order of the harmonic.

Syntax

```
[SOURce[1|2]]:HARMonic:ORDER <value>|MINimum|MAXimum  
[SOURce[1|2]]:HARMonic:ORDER? [MINimum|MAXimum]
```

Arguments

<value>::=<NR1>

where:

<NR1> is the order of harmonic (2 to 16).

Returns

<value>

Example

:HARMonic:ORDEr 7

sets the order of the harmonic to 7.

[SOURce[1|2]]:HARMonic:PHASe

This command sets or queries the phase of the specified order of harmonic.

Syntax

[SOURce[1|2]]:HARMonic:PHASe <sn>,<phase>|MINimum|MAXimum

[SOURce[1|2]]:HARMonic:PHASe? <sn>[,MINimum|MAXimum]

Arguments

<sn>::=<NR1>

where:

<NR1> is the specified order of harmonic (2 to 16).

<phase>::=<NR3>[<units>]

where:

<NR3> is the phase of the specified order of harmonic.

<units>::=[RAD|DEG]

If <units> are omitted, RAD is specified automatically. The setting ranges are:

RAD: 0 to +2 PI, relative to phase value

DEG: 0 to +360, relative to phase value

Returns

<phase>

Example

:HARMonic:PHASe 2,90

sets the phase of the second order of harmonic to 90°.

[SOURce[1|2]]:HARMonic:TYPE

This command sets or queries the harmonic type (EVEN, ODD, ALL or USER).

Syntax

[SOURce[1|2]]:HARMonic:TYPe EVEN|ODD|ALL|USER
[SOURce[1|2]]:HARMonic:TYPe?

Arguments

EVEN specifies the harmonic type as even.

ODD specifies the harmonic type as odd.

ALL specifies the harmonic type as all.

USER specifies the harmonic type as user.

Returns

EVEN|ODD|ALL|USER

Example

:HARMonic:TYPe ODD

sets the harmonic type to ODD.

[SOURce[1|2]]:MOD:STATe

This command enables or disables the modulation function for the specified channel. The query returns the state of modulation function.

Syntax

[SOURce[1|2]]:MOD:STATe {ON|OFF|<NR1>}

[SOURce[1|2]]:MOD:STATe?

Arguments

ON or <NR1>≠0 enables the modulation function.

OFF or <NR1>=0 disables the modulation function.

Returns

<NR1>

Examples

SOURce1:MOD:STATe ON

enables the modulation function for the CH1.

[SOURce[1|2]]:OSKey:INTernal:RATE

This command sets or queries the internal modulation rate of OSK modulation for the specified channel.

Syntax

[SOURce[1|2]]:OSKey:INTernal:RATE {<rate>|MINimum|MAXimum}
[SOURce[1|2]]:OSKey:INTernal:RATE? {MINimum|MAXimum}

Arguments

<rate>::=<NRf>[<units>]

where:

<NRf> is the modulation rate.

<units>::=[Hz|kHz|MHz]

Returns

<rate>

Examples

SOURce1:OSKey:INTernal:RATE 50Hz

sets the CH1 internal OSK modulation rate to 50 Hz.

[SOURce[1|2]]:OSKey:STATe

This command enables or disables OSK modulation. The query returns the state of OSK modulation. The carrier waveform can only be a sine wave.

Syntax

[SOURce[1|2]]:OSKey:STATe {ON|OFF|<NR1>}
[SOURce[1|2]]:OSKey:STATe?

Arguments

ON or <NR1>≠0 enables OSK modulation.

OFF or <NR1>=0 disables OSK modulation.

Returns

<NR1>

Examples

SOURce1:OSKey:STATe ON

enables the CH1 OSK modulation.

[SOURce[1|2]]:OSKey:TIME

This command sets or queries the oscillate period for the OSK modulation for the specified channel.

Syntax

```
[SOURce[1|2]]:OSKey:TIME {<seconds>|MINimum|MAXimum}  
[SOURce[1|2]]:OSKey:TIME?
```

Arguments

<seconds>::=<NRf>[<units>]

where:

<NRf> is the oscillate period in seconds.

<units>::=[ns|us|ms|s]

Returns

<seconds>

Examples

```
SOURce1:OSKey:TIME 100us
```

sets the CH1 OSK oscillate period to 100 us.

[SOURce[1|2]]:PHASe[:ADJust]

This command sets or queries the phase of output waveform for the specified channel. Set the value in radians or degrees. If no units are specified, the default is RAD. The query returns the value in RAD.

This command is supported when you select a waveform other than DC and Noise.

Syntax

```
[SOURce[1|2]]:PHASe[:ADJust] {<phase>|MINimum|MAXimum}  
[SOURce[1|2]]:PHASe[:ADJust]? {MINimum|MAXimum}
```

Arguments

<phase>::=<NR3>[<units>]

where:

<NR3> is the phase of output waveform.

<units>::=[RAD|DEG]

If <units> are omitted, RAD is specified automatically. The setting ranges are:

RAD: 0 to +2 PI, relative to phase value

DEG: 0 to +360, relative to phase value

Returns

<phase>

Examples

SOURce1:PHASe:ADJJust MAXimum

sets the maximum value for the phase of CH1 output waveform.

[SOURce[1|2]]:PHASe:INITiate (No Query Form)

This command synchronizes the phase of CH1 and CH2 output waveforms. The arbitrary generator performs the same operation if you specify either SOURce1 or SOURce2.

Syntax

[SOURce[1|2]]:PHASe:INITiate

Arguments

None

Examples

SOURce1:PHASe:INITiate

synchronizes the phase of CH1 and CH2 output signals.

[SOURce[1|2]]:PM[:DEViation]

This command sets or queries the phase deviation of PM modulation for the specified channel.

Syntax

[SOURce[1|2]]:PM[:DEViation] {<deviation>|MINimum|MAXimum}

[SOURce[1|2]]:PM[:DEViation]? [MINimum|MAXimum]

Arguments

<deviation>::=<NR3>[<units>]

where:

<NR3> is the phase deviation.

<units>::=[RAD|DEG]

If <units> are omitted, RAD is specified automatically. The setting ranges are:

RAD: 0 PI to +1 PI, relative to phase value

DEG: 0 to +180, in 1 degree steps, relative to phase value

Returns

<deviation>

Examples

SOURce1:PM:DEViation MAXimum

sets the maximum value for the CH1 phase deviation of PM modulation.

[SOURce[1|2]]:PM:INTernal:FREQuency

This command sets or queries the internal modulation frequency of PM modulation for the specified channel. Use this command when the internal modulation source is selected.

Set the internal modulation frequency from 2 mHz to 100.00 kHz with resolution of 1 mHz.

Syntax

[SOURce[1|2]]:PM:INTernal:FREQuency {<frequency>|MINimum|MAXimum}

[SOURce[1|2]]:PM:INTernal:FREQuency? [MINimum|MAXimum]

Arguments

<frequency>::=<NRf>[<units>]

where:

<NRf> is the modulation frequency.

<units>::=[Hz|kHz|MHz]

Returns

<frequency>

Examples

SOURce1:PM:INTernal:FREQuency 10kHz

sets the CH1 internal modulation frequency to 10 kHz.

[SOURce[1|2]]:PM:INTernal:FUNCTion

This command sets or queries the modulating waveform of PM modulation for the specified channel. Use this command when the internal modulation source is selected.

If you specify EFILe when there is no EFILe or the EFILe is not yet defined, this command causes an error.

Syntax

[SOURce[1|2]]:PM:INTernal:FUNCTion {SINusoid|SQUare|RAMP|PRNoise

|USER<NR1>|EMEMory|EFILe}
[SOURce[1|2]]:PM:INTernal:FUNcTion?

Arguments

USER<NR1>|EMEMory

<NR1> specifies the user waveform memory location, can be any number from 0 to 15. A user defined waveform saved in the user waveform memory or the EMEMory can be selected as a modulating signal.

EFILe

EFILe is used as a modulating signal.

Returns

SIN|SQU|RAMP|PRN|USER<NR1>|EMEMory|EFILe

Examples

SOURce1:PM:INTernal:FUNcTion SQUare

selects Square as the shape of modulating waveform for the CH1 output.

[SOURce[1|2]]:PM:INTernal:FUNcTion:EFILe

This command sets or queries an EFILe name used as a modulating waveform for PM modulation. A file name must be specified in the mass storage system. This command returns " " if there is no file in the mass storage.

Syntax

[SOURce[1|2]]:PM:INTernal:FUNcTion:EFILe <file_name>

[SOURce[1|2]]:PM:INTernal:FUNcTion:EFILe?

Arguments

<file_name>::=<string> specifies a file name in the mass storage system. The <file_name> includes path. Path separators are forward slashes (/).

Returns

<file_name>

Examples

SOURce1:PM:INTernal:FUNcTion:EFILe "TEST"

sets a file named "TEST" in the mass storage.

[SOURce[1|2]]:PM:SOURce

This command sets or queries the source of modulation signal of PM modulation for the specified channel.

Syntax

```
[SOURce[1|2]]:PM:SOURce [INTernal|EXTernal]  
[SOURce[1|2]]:PM:SOURce?
```

Arguments

INTernal means that the carrier waveform is modulated with an internal source.

EXTernal means that the carrier waveform is modulated with an external source.

Returns

INT|EXT

Examples

```
SOURce1:PM:SOURce INTernal  
sets the CH1 source of modulating signal to internal.
```

[SOURce[1|2]]:PM:STATe

This command enables or disables PM modulation. The query returns the state of PM modulation. Select a sine, square, ramp, or arbitrary waveform as the carrier waveform.

Syntax

```
[SOURce[1|2]]:PM:STATe {ON|OFF|<NR1>}  
[SOURce[1|2]]:PM:STATe?
```

Arguments

ON or <NR1>≠0 enables PM modulation.

OFF or <NR1>=0 disables PM modulation.

Returns

<NR1>

Examples

```
SOURce1:PM:STATe ON  
enables the CH1 PM modulation.
```

[SOURce[1|2]]:PSKey[:DEViation]

This command sets or queries the phase deviation of PSK modulation for the specified channel.

Syntax

```
[SOURce[1|2]]:PSKey[:DEViation] {<deviation>|MINimum|MAXimum}  
[SOURce[1|2]]:PSKey[:DEViation]? [MINimum|MAXimum]
```

Arguments

<deviation>::=<NR3>[<units>]

where:

<NR3> is the phase deviation.

<units>::=[RAD|DEG]

If <units> are omitted, RAD is specified automatically. The setting ranges are:

RAD: 0 PI to +1 PI, relative to phase value

DEG: 0 to +180, in 1 degree steps, relative to phase value

Returns

<deviation>

Examples

```
SOURce1:PSKey:DEViation MAXimum
```

sets the maximum value for the CH1 phase deviation of PSK modulation.

[SOURce[1|2]]:PSKey:INTernal:RATE

This command sets or queries the internal modulation rate of PSK modulation for the specified channel. Use this command when the internal modulation source is selected.

Syntax

```
[SOURce[1|2]]:PSKey:INTernal:RATE {<rate>|MINimum|MAXimum}  
[SOURce[1|2]]:PSKey:INTernal:RATE? {MINimum|MAXimum}
```

Arguments

<rate>::=<NRf>[<units>]

where:

<NRf> is the modulation rate.

<units>::=[Hz|kHz|MHz]

Returns

<rate>

Examples

SOURce1:PSKey:INTernal:RATE 50Hz
sets the CH1 internal modulation rate to 50 Hz.

[SOURce[1|2]]:PSKey:SOURce

This command sets or queries the source of modulation signal of PSK modulation for the specified channel.

Syntax

[SOURce[1|2]]:PSKey:SOURce [INTernal|EXTernal]
[SOURce[1|2]]:PSKey:SOURce?

Arguments

INTernal means that the carrier waveform is modulated with an internal source.
EXTernal means that the carrier waveform is modulated with an external source.

Returns

INT|EXT

Examples

SOURce1:PSKey:SOURce INTernal
sets the CH1 source of modulating signal to internal.

[SOURce[1|2]]:PSKey:STATe

This command enables or disables PSK modulation. The query returns the state of PSK modulation. Select a sine, square, ramp, or arbitrary waveform as the carrier waveform.

Syntax

[SOURce[1|2]]:PSKey:STATe {ON|OFF|<NR1>}
[SOURce[1|2]]:PSKey:STATe?

Arguments

ON or <NR1>≠0 enables PSK modulation.
OFF or <NR1>=0 disables PSK modulation.

Returns

<NR1>

Examples

SOURce1:PSKey:STATe ON
enables the CH1 PSK modulation.

[SOURce[1|2]]:PULSe:DCYCLE

This command sets or queries the duty cycle of the pulse waveform for the specified channel.

This parameter is related to the pulse width and when any of them is changed, the other will be modified automatically.

The pulse duty cycle is limited by the minimum pulse width and pulse period.

pulse duty cycle $\geq 100\% \times \text{minimum pulse width} \div \text{pulse period}$

pulse duty cycle $\leq 100\% \times (1 - 2 \times \text{minimum pulse width} \div \text{pulse period})$

Syntax

[SOURce[1|2]]:PULSe:DCYCLE {<percent>|MINimum|MAXimum}

[SOURce[1|2]]:PULSe:DCYCLE? [MINimum|MAXimum]

Arguments

<percent>::=<NR2>[<units>]

where:

<NR2> is the duty cycle.

<units>::=PCT

Returns

<percent>

Examples

SOURce1:PULSe:DCYCLE 80.5
sets the duty cycle of the pulse waveform on CH1 to 80.5%.

[SOURce[1|2]]:PULSe:TRANSition[:LEADing]

This command sets or queries the leading edge time of pulse waveform.

Syntax

[SOURce[1|2]]:PULSe:TRANSition[:LEADing] {<seconds>|MINimum|MAXimum}

[SOURce[1|2]]:PULSe:TRANSition[:LEADing]?[MINimum|MAXimum]

Arguments

<seconds>::=<NRf>[<units>]

where

<NRf> is the leading edge time of pulse waveform.

<units>::=[ns|us|ms|s]

Returns

<seconds>

Examples

SOURce1:PULSe:TRANSition:LEADing 200ns

sets the CH 1 leading edge time to 200 ns.

[SOURce[1|2]]:PULSe:TRANSition:TRAILing

This command sets or queries the trailing edge time of pulse waveform.

Syntax

[SOURce[1|2]]:PULSe:TRANSition:TRAILing {<seconds>|MINimum|MAXimum}

[SOURce[1|2]]:PULSe:TRANSition:TRAILing?[MINimum|MAXimum]

Arguments

<seconds>::=<NRf>[<units>]

where

<NRf> is the trailing edge of pulse waveform.

<units>::=[ns|us|ms|s]

Returns

<seconds>

Examples

SOURce1:PULSe:TRANSition:TRAILing 200ns

sets the trailing edge time to 200 ns.

[SOURce[1|2]]:PULSe:WIDTh

This command sets or queries the pulse width for the specified channel.

Syntax

```
[SOURce[1|2]]:PULSe:WIDTh {<seconds>|MINimum|MAXimum}  
[SOURce[1|2]]:PULSe:WIDTh?[MINimum|MAXimum]
```

Arguments

<seconds>::=<NRf>[<units>]

where

<NRf> is the pulse width.

<units>::=[ns|us|ms|s]

Returns

<seconds>

Examples

```
SOURce1:PULSe:WIDTh 200ns
```

sets the CH 1 pulse width to 200 ns.

[SOURce[1|2]]:PWM:INTernal:FREQUENCY

This command sets or queries the internal modulation frequency of PWM modulation for the specified channel. Use this command when the internal modulation source is selected. Set the internal modulation frequency from 2 mHz to 100.00 kHz with resolution of 1 mHz. Select the source of modulating signal by using the [SOURce[1|2]]:PWM:SOURce [INTernal|EXTernal] command.

Syntax

```
[SOURce[1|2]]:PWM:INTernal:FREQUENCY {<frequency>|MINimum|MAXimum}  
[SOURce[1|2]]:PWM:INTernal:FREQUENCY?
```

Arguments

<frequency>::=<NRf>[<units>]

where <NRf> is the modulation frequency.

<units>::=[Hz|kHz|MHz]

Returns

<frequency>

Examples

```
SOURce1:PWM:INTernal:FREQUENCY 10kHz
```

sets the CH1 internal modulation frequency of PWM modulation to 10 kHz.

[SOURce[1|2]]:PWM:INTernal:FUNCTion

This command sets or queries the modulating waveform of PWM modulation for the specified channel. Use this command when the internal modulation source is selected. If you specify EFILE when there is no EFILE or the EFILE is not yet defined, this command causes an error.

Syntax

```
[SOURce[1|2]]:PWM:INTernal:FUNCTion {SINusoid|SQUare|RAMP|PRNoise  
|USER<NR1>|EMEMory|EFILE}  
[SOURce[1|2]]:PWM:INTernal:FUNCTion?
```

Arguments

SINusoid|SQUare|RAMP|PRNoise

One of four types of function waveform can be selected as a modulating signal.

USER<NR1>|EMEMory

<NR1> specifies the user waveform memory location, can be any number from 0 to 31.

A user defined waveform saved in the user waveform memory or the EMEMory can be selected as a modulating signal.

EFILE

EFILE is used as a modulating signal.

Returns

SIN|SQU|RAMP|PRN|USER<NR1>|EMEMory|EFILE

Examples

```
SOURce1:PWM:INTernal:FUNCTion SQUare
```

selects Square as the shape of modulating waveform of PWM modulation for the CH1 output.

[SOURce[1|2]]:PWM:INTernal:FUNCTion:EFILE

This command sets or queries an EFILE name used as a modulating waveform for PWM modulation. A file name must be specified in the mass storage system. This command returns " " if there is no file in the mass storage.

Syntax

```
[SOURce[1|2]]:PWM:INTernal:FUNCTion:EFILE <file_name>  
[SOURce[1|2]]:PWM:INTernal:FUNCTion:EFILE?
```

Arguments

<file_name>::=<string> specifies a file name in the mass storage system. The <file_name> includes path. Path separators are forward slashes (/).

Returns

<file_name>

Examples

SOURce1:PWM:INTernal:FUNctIon:EFILe "TEST"
creates a file named "TEST" in the mass storage.

[SOURce[1|2]]:PWM:SOURce

This command sets or queries the source of modulating signal of PWM modulation for the specified channel.

Syntax

[SOURce[1|2]]:PWM:SOURce [INTernal|EXTernal]
[SOURce[1|2]]:PWM:SOURce?

Arguments

INTernal means that the carrier waveform is modulated with the internal source.
EXTernal means that the carrier waveform is modulated with an external source.

Returns

INT|EXT

Examples

SOURce1:PWM:SOURce INTernal
sets the source of modulating signal on CH1 to internal.

[SOURce[1|2]]:PWM:STATe

This command enables or disables PWM modulation. The query returns the state of PWM modulation. Select only pulse waveform as a carrier waveform for PWM.

Syntax

[SOURce[1|2]]:PWM:STATe {ON|OFF|<NR1>}
[SOURce[1|2]]:PWM:STATe?

Arguments

ON or <NR1>≠0 enables PWM modulation.
OFF or <NR1>=0 disables PWM modulation.

Returns

<NR1>

Examples

SOURce1:PWM:STATe ON
enables the CH1 PWM modulation.

[SOURce[1|2]]:PWM[:DEViation]:DCYCLE

This command sets or queries the PWM deviation in percent for the specified channel.

Syntax

[SOURce[1|2]]:PWM[:DEViation]:DCYCLE {<percent>|MINimum|MAXimum}
[SOURce[1|2]]:PWM[:DEViation]:DCYCLE?

Arguments

<percent>::=<NR2>[<units>]

where:

<NR2> is the PWM deviation.

<units>::=PCT

Returns

<percent>

Examples

SOURce1:PWM:DEViation:DCYCLE 5.0
sets the CH1 PWM deviation to 5.0%.

[SOURce[1|2]]:SWEep:SOURce

This command sets or queries the trigger source in the sweep mode for the specified channel.

Syntax

[SOURce[1|2]]:SWEep:SOURce [TIMER|MANual|EXternal]

[SOURce[1|2]]:SWEep:SOURce?

Arguments

TIMer specifies an internal clock as the trigger source.

MANual specifies a manual trigger input as the trigger source.

EXTernal specifies an external trigger input as the trigger source.

Returns

TIM|MAN|EXT

Examples

SOURce1:SWEep:SOURce EXTernal

sets an external trigger input as the trigger source in the sweep mode.

[SOURce[1|2]]:SWEep:SPACing

This command selects linear or logarithmic spacing for the sweep for the specified channel.

The query returns the type for the sweep spacing for the specified channel.

Syntax

[SOURce[1|2]]:SWEep:SPACing {LINear|LOGarithmic}

[SOURce[1|2]]:SWEep:SPACing?

Arguments

LINear sets the sweep spacing to linear.

LOGarithmic sets the sweep spacing to logarithmic.

Returns

LIN|LOG

Examples

SOURce1:SWEep:SPACing LINear

sets the CH1 sweep spacing to linear.

[SOURce[1|2]]:SWEep:STATe

This command enables or disables the sweep mode for the specified channel. The query returns the state of sweep mode.

Syntax

[SOURce[1|2]]:SWEep:STATe {ON|OFF|<NR1>}
[SOURce[1|2]]:SWEep:STATe?

Arguments

ON or <NR1>≠0 enables the sweep mode.
OFF or <NR1>=0 disables the sweep mode.

Returns

<NR1>

Examples

SOURce1:SWEep:STATe ON
enables the sweep mode for the CH1.

[SOURce[1|2]]:SWEep:TIME

This command sets or queries the sweep time for the sweep for the specified channel. The sweep time does not include hold time and return time. The setting range is 1 ms to 500 s.

Syntax

[SOURce[1|2]]:SWEep:TIME {<seconds>|MINimum|MAXimum}
[SOURce[1|2]]:SWEep:TIME?

Arguments

<seconds>::=<NRf>[<units>]

where:

<NRf> is the sweep time in seconds.

<units>::=[ns|us|ms|s]

Returns

<seconds>

Examples

SOURce1:SWEep:TIME 100ms
sets the CH1 sweep time to 100 ms.

[SOURce[1|2]]:VOLTage[:LEVel][:IMMediate]:OFFSet

This command sets or queries the offset level for the specified channel.

Syntax

```
[SOURce[1|2]]:VOLTage[:LEVel][:IMMediate]:OFFSet {<voltage>|MINimum|MAXimum}  
[SOURce[1|2]]:VOLTage[:LEVel][:IMMediate]:OFFSet? {MINimum|MAXimum}
```

Arguments

<voltage>::=<NR3>[<units>]

where:

<NR3> is the offset voltage level.

<units>::=[mV|V]

Returns

<voltage>

Examples

SOURce1:VOLTage:LEVel:IMMediate:OFFSet 500mV
sets the CH1 offset level to 500 mV.

[SOURce[1|2]]:VOLTage[:LEVel][:IMMediate][:AMPLitude]

This command sets or queries the output amplitude for the specified channel. The amplitude resolution is 1 mVpp or four digits.

Syntax

```
[SOURce[1|2]]:VOLTage[:LEVel][:IMMediate][:AMPLitude]  
{<amplitude>|MINimum|MAXimum}  
[SOURce[1|2]]:VOLTage[:LEVel][:IMMediate][:AMPLitude]? {MINimum|MAXimum}
```

Arguments

<amplitude>::=<NR3>[<units>]

where:

<NR3> is the output amplitude.

<units>::=[mVpp|Vpp]

Returns

<amplitude>

Examples

SOURce1:VOLTage:LEVel:IMMediate:AMPLitude 1Vpp
sets the CH1 output amplitude to 1 Vpp.

SYSTem:BEEPer[:IMMediate] (No Query Form)

This command causes the instrument to beep immediately. This command is only available when the beeper is enabled.

Syntax

SYSTem:BEEPer[:IMMediate]

Arguments

None

Examples

SYSTEM:BEEPER
causes a beep.

SYSTem:BEEPer:STATe

The SYSTem:BEEPer:STATe command sets the beeper ON or OFF.
The SYSTem:BEEPer:STATe? command returns "0" (OFF) or "1" (ON).
When the beeper is set to ON, the instrument will beep when an error message or a warning message is displayed on the screen. The instrument does not beep when an error or warning caused by remote command execution.

Syntax

SYSTem:BEEPer:STATe {ON|OFF|<NR1>}
SYSTem:BEEPer:STATe?

Arguments

ON or <NR1>≠0 enables the beeper.
OFF or <NR1>=0 disables the beeper.

Returns

<NR1>

Examples

SYSTEM:BEEPER:STATE ON

enables the beeper function.

SYSTem:ERRor[:NEXT]? (Query Only)

This query-only command returns the contents of the Error/Event queue.

Syntax

SYSTem:ERRor[:NEXT]?

Arguments

None

Returns

<Error/event number>::=<NR1>

<Error/event description>::=<string>

Examples

SYSTEM:ERROR:NEXT?

might return the following response:

-201,"Invalid while in local"

If the instrument detects an error or an event occurs, the event number and event message will be returned.

SYSTem:KLOCK[:STATe]

This command locks or unlocks the instrument front panel controls. The query command returns "0" (OFF) or "1" (ON).

Syntax

SYSTem:KLOCK[:STATe] {ON|OFF|<NR1>}

SYSTem:KLOCK[:STATe]?

Arguments

ON or <NR1>≠0 locks front panel controls.

OFF or <NR1>=0 unlocks front panel controls.

Returns

<NR1>

Examples

SYSTEM:KLOCK ON
locks front panel controls.

SYSTem:LANguage

This command sets or queries the language that the instrument uses to display information on the screen.

Different languages may support different types of languages.

Syntax

SYSTem:LANguage
{SCHinese|TCHinese|ENGLish|PORTuguese|GERMan|POLish|KORean|JAPAnese}
SYSTem:LANguage?

Arguments

SCHinese|TCHinese|ENGLish|PORTuguese|GERMan|POLish|KORean|JAPAnese
specifies which language will be used to display instrument information on the screen.

Returns

SCH|TCH|ENGL|PORT|GERM|POL|KOR|JAPA

Examples

SYSTEM:LANGUAGE ENGLish
specifies that the instrument displays information in English.

SYSTem:POWeron

Set the configuration to be used by the instrument at power-on to DEFault or LAsT.

Query the configuration to be used by the instrument at power-on.

Syntax

SYSTem:POWeron [DEFault|LAsT]
SYSTem:POWeron?

Arguments

DEFault means that set the configuration to be used by the instrument at power-on to default setup.

LAsT means that set the configuration to be used by the instrument at power-on to last setup.

Returns

DEF|LAS

Examples

SYSTem:POWeron LAST

sets the configuration to be used by the instrument at power-on to LAST.

SYSTem:POWeron?

returns LAS.

SYSTem:RESTART

This command restarts the instrument.

Syntax

SYSTem:RESTART

Arguments

None

Examples

SYSTem:RESTART

restarts the instrument.

SYSTem:VERSion? (Query Only)

This query-only command returns the software version of the instrument.

Syntax

SYSTem:VERSion?

Arguments

None

Returns

<Software Version>::=Vx.x.x

where:

x – indicates the version number.

Examples

SYSTEM:VERSION?
might return V1.2.4.

TRACe|DATA:CATalog? (Query Only)

This query-only command returns the names of user waveform memory and edit memory.

Syntax

TRACe|DATA:CATalog?

Arguments

None

Returns

<string>

A series of strings separated by commas is returned. Each string is enclosed within quotation marks.

Examples

DATA:CATALOG?

might return "USER0","USER2","EMEM"

TRACe|DATA:COPY (No Query Form)

This command copies the contents of edit memory (or user waveform memory) to a specified user waveform memory (or edit memory).

Syntax

TRACe|DATA:COPY <trace_name>,EMEMory

TRACe|DATA:COPY EMEMory,{USER<NR1>}

Arguments

<trace_name>::={USER<NR1>}

<NR1> specifies the user waveform memory location, can be any number from 0 to 31.

Examples

DATA:COPY USER0,EMEMory

copies the waveform data in the edit memory to the user waveform memory USER0.

DATA:COPY EMEMory,USER0

copies the waveform data in the user waveform memory USER0 to the edit memory.

TRACe|DATA[:DATA]

This command transfers the waveform data from the external controller to the edit memory in the instrument. The query returns the binary block data.

Syntax

```
TRACe|DATA[:DATA] EMEMory,<binary_block_data>  
TRACe|DATA[:DATA]? EMEMory
```

Arguments

<binary_block_data>

where <binary_block_data> is the waveform data in binary format.

Returns

<binary_block_data>

Examples

```
DATA:DATA EMEMory,#42000<DAB><DAB>...<DAB>
```

transmits a waveform to the edit memory in the instrument. The block data element #21000 indicates that 2 is the number of digits in 1000 (byte count) and the 1000 bytes of binary data are to be transmitted.

TRACe|DATA[:DATA]:VALue

This command sets or queries the data value at the specified point in the edit memory.

Syntax

```
TRACe|DATA[:DATA]:VALue EMEMory,<point>,<data>  
TRACe|DATA[:DATA]:VALue? EMEMory,<point>
```

Arguments

<point>::=<NR1>

where:

<NR1> is the specified point number in the edit memory.

<data>::=<NRf>

where:

<NRf> is the voltage value for the specified point number.

<units>::=[mV|V]

Returns

<NRf>

Examples

DATA:DATA:VALue EMEMory,200,1.5V

sets the voltage value to 1.5V for the point number 200 in the edit memory.

DATA:DATA:VALue? EMEMory,200

might return "1.5000000+e0".

This example indicates that the voltage value of point number 200 is set to 1.5V.

TRACe|DATA:POINts

This command sets or queries the number of data points for the waveform created in the edit memory.

Syntax

TRACe|DATA:POINts EMEMory[,<points>|MINimum|MAXimum]

TRACe|DATA:POINts? EMEMory{,MIN|MAX}

Arguments

<points>::=<NR1>

where

<NR1> sets the number of points for the waveform created in the edit memory, can be any number from 2 to 100,000.

Returns

<NR1>

Examples

DATA:POINts EMEMory, 500

sets the waveform data points to 500 in the edit memory.

***TRG (No Query Form)**

This command generates a trigger event for both CH1 and CH2.

Syntax

*TRG

Arguments

None

Examples

*TRG

generates a trigger event for both CH1 and CH2.

3. Command Errors

The following table shows the error messages generated by improper command syntax. Check that the command is properly formed and that it follows the rules in the Syntax and Commands.

Command messages

Code	Message
0 (indicates no error)	
-101	Invalid character
-102	Syntax error
-108	Parameter not allowed
-201	Invalid while in local

Error/Event Queue

The event queue is an FIFO queue, which stores events as they occur in the instrument. The event queue can store up to 64 events.

The oldest error code and text are retrieved by using the following command:

```
SYSTem:ERRor[:NEXT]?
```

4. Index

*

*CLS, 3

*IDN?, 10

*RCL, 13

*RST, 14

*SAV, 14

*TRG, 67

[

[SOURCE[1 | 2]]:3FSKey:INTERNAL:RATE, 35

[SOURCE[1 | 2]]:3FSKey:STATE, 36

[SOURCE[1 | 2]]:3FSKey[:FREQUENCY], 35

[SOURCE[1 | 2]]:4FSKey:INTERNAL:RATE, 37

[SOURCE[1 | 2]]:4FSKey:STATE, 38

[SOURCE[1 | 2]]:4FSKey[:FREQUENCY], 36

[SOURCE[1 | 2]]:AM:INTERNAL:FREQUENCY,
15

[SOURCE[1 | 2]]:AM:INTERNAL:FUNCTION, 16

[SOURCE[1 | 2]]:AM:INTERNAL:FUNCTION:EFIL
Le, 16

[SOURCE[1 | 2]]:AM:SOURCE, 17

[SOURCE[1 | 2]]:AM:STATE, 17

[SOURCE[1 | 2]]:AM[:DEPTH], 15

[SOURCE[1 | 2]]:ASKey:INTERNAL:RATE, 19

[SOURCE[1 | 2]]:ASKey:SOURCE, 19

[SOURCE[1 | 2]]:ASKey:STATE, 20

[SOURCE[1 | 2]]:ASKey[:AMPLITUDE], 18

[SOURCE[1 | 2]]:BPSKey:DATA, 20

[SOURCE[1 | 2]]:BPSKey:INTERNAL:RATE, 21

[SOURCE[1 | 2]]:BPSKey:PHASE, 21

[SOURCE[1 | 2]]:BPSKey:STATE, 22

[SOURCE[1 | 2]]:BURSt:GATE:POLarity, 22

[SOURCE[1 | 2]]:BURSt:INTERNAL:PERiod, 23

[SOURCE[1 | 2]]:BURSt:MODE, 23

[SOURCE[1 | 2]]:BURSt:NCYCles, 24

[SOURCE[1 | 2]]:BURSt:SOURCE, 25

[SOURCE[1 | 2]]:BURSt:STATE, 25

[SOURCE[1 | 2]]:FM:INTERNAL:FREQUENCY,
26

[SOURCE[1 | 2]]:FM:INTERNAL:FUNCTION, 27

[SOURCE[1 | 2]]:FM:INTERNAL:FUNCTION:EFIL
e, 27

[SOURCE[1 | 2]]:FM:SOURCE, 28

[SOURCE[1 | 2]]:FM:STATE, 28

[SOURCE[1 | 2]]:FM[:DEVIation], 26

[SOURCE[1 | 2]]:FREQUENCY:CENTer, 29

[SOURCE[1 | 2]]:FREQUENCY:CONCurent,
30

[SOURCE[1 | 2]]:FREQUENCY:SPAN, 31

[SOURCE[1 | 2]]:FREQUENCY:START, 31

[SOURCE[1 | 2]]:FREQUENCY:STOP, 32

[SOURCE[1 | 2]]:FREQUENCY[:FIXed], 30

[SOURCE[1 | 2]]:FSKey:INTERNAL:RATE, 33

[SOURCE[1 | 2]]:FSKey:SOURCE, 34

[SOURCE[1 | 2]]:FSKey:STATE, 34

[SOURCE[1 | 2]]:FSKey[:FREQUENCY], 33

[SOURCE[1 | 2]]:FUNCTION:EFILe, 38

[SOURCE[1 | 2]]:FUNCTION:RAMP:SYMMetr
y, 39

[SOURCE[1 | 2]]:FUNCTION[:SHAPE], 39

[SOURCE[1 | 2]]:HARMonic:AMPL, 41

[SOURCE[1 | 2]]:HARMonic:ORDER, 41

[SOURCE[1 | 2]]:HARMonic:PHASe, 42

[SOURCE[1 | 2]]:HARMonic:TYPE, 42

[SOURCE[1 | 2]]:MOD:STATE, 43

[SOURCE[1 | 2]]:OSKey:INTERNAL:RATE, 43

[SOURCE[1 | 2]]:OSKey:STATE, 44

[SOURce[1 | 2]]:OSKey:TIME, 45
[SOURce[1 | 2]]:PHASe:INITiate, 46
[SOURce[1 | 2]]:PHASe[:ADJust], 45
[SOURce[1 | 2]]:PM:INTernal:FREQuency, 47
[SOURce[1 | 2]]:PM:INTernal:FUNcTion, 47
[SOURce[1 | 2]]:PM:INTernal:FUNcTion:EFILe, 48
[SOURce[1 | 2]]:PM:SOURce, 49
[SOURce[1 | 2]]:PM:STATe, 49
[SOURce[1 | 2]]:PM[:DEViation], 46
[SOURce[1 | 2]]:PSKey:INTernal:RATE, 50
[SOURce[1 | 2]]:PSKey:SOURce, 51
[SOURce[1 | 2]]:PSKey:STATe, 51
[SOURce[1 | 2]]:PSKey[:DEViation], 50
[SOURce[1 | 2]]:PULSe:DCYCLe, 52
[SOURce[1 | 2]]:PULSe:TRANSition:TRAILing, 53
[SOURce[1 | 2]]:PULSe:TRANSition[:LEADing], 52
[SOURce[1 | 2]]:PULSe:WIDTh, 53
[SOURce[1 | 2]]:PWM:INTernal:FREQuency, 54
[SOURce[1 | 2]]:PWM:INTernal:FUNcTion, 55
[SOURce[1 | 2]]:PWM:INTernal:FUNcTion:EFILe, 55
[SOURce[1 | 2]]:PWM:SOURce, 56
[SOURce[1 | 2]]:PWM:STATe, 56
[SOURce[1 | 2]]:PWM[:DEViation]:DCYCLe, 57
[SOURce[1 | 2]]:SWEep:SOURce, 57
[SOURce[1 | 2]]:SWEep:SPACing, 58
[SOURce[1 | 2]]:SWEep:STATe, 58
[SOURce[1 | 2]]:SWEep:TIME, 59
[SOURce[1 | 2]]:VOLTage[:LEVel][:IMMediate]:OFFSet, 60

[SOURce[1 | 2]]:VOLTage[:LEVel][:IMMediate]:AMPLitude], 60

A

AFGControl:CSCopy, 3

C

COUNter:COUPing, 3

COUNter:DUTYcycle?, 4

COUNter:FREQ?, 4

COUNter:HFR, 5

COUNter:PERiod?, 5

COUNter:PULSewidth?, 6

COUNter:SENSitivity, 6

COUNter:TRIGger, 7

D

DISPlay:BRIGhtness, 7

DISPlay:SAVer:DELay, 8

DISPlay:SAVer:IMMediate, 8

DISPlay:SAVer[:STATe], 9

H

HCOPy:SDUMp:DATA?, 9

HCOPy:SDUMp[:IMMediate], 10

M

MMEMory:CATalog?, 11

MMEMory:CDIRectory, 11

MMEMory:DELeTe, 12

O

OUTPut[1|2]:IMPedance, 12

OUTPut[1|2][:STATe], 13

S

SYSTem:BEEPer:STATe, 61

SYSTem:BEEPer[:IMMEDIATE], 61

SYSTem:ERRor[:NEXT]?, 62

SYSTem:KLOCK[:STATe], 62

SYSTem:LANguage, 63

SYSTem:POWeron, 63

SYSTem:RESTART, 64

SYSTem:VERSion?, 64

T

TRACe|DATA:CATalog?, 65

TRACe|DATA:COPI, 65

TRACe|DATA:POINts, 67

TRACe|DATA[:DATA], 66

TRACe|DATA[:DATA]:VALue, 66