

500 kHz Lock-In Amplifier

SR860 — 500 kHz dual phase lock-in amplifier

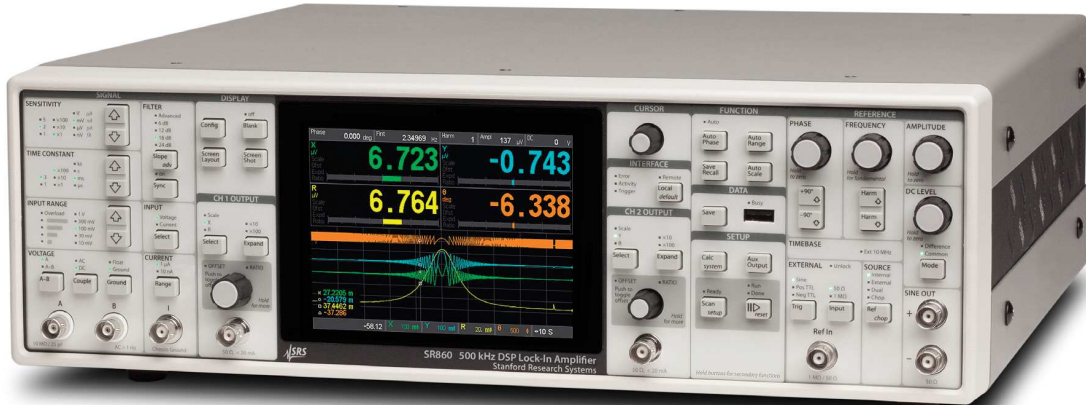

SR860 500 kHz Lock-In Amplifier

- 1 MHz to 500 kHz frequency range
- Low-noise current and voltage inputs
- Touchscreen data display - large numeric results, chart recordings, & FFT displays
- 10 MHz timebase input and output
- Dual reference mode
- GPIB, RS-232, Ethernet and USB
- HDMI video output

• SR860 ... \$6495 (U.S. list)

Superb performance. Outstanding value. They're what you've come to expect from a Stanford Research Systems lock-in amplifier. And they're delivered by the new SR860 500kHz Lock-in Amplifier, the latest in a line of innovative lock-ins from SRS. With unparalleled analog performance, sophisticated new digital signal processing features, a thoroughly modern, intuitive user interface, and a wide range of computer connectivity options, the SR860 is the ideal choice for any synchronous detection application.

With over 30 years of lock-in design experience SRS has made every effort to optimize each detail of the SR860. From a hefty toroidal transformer that eliminates switch-mode noise to iOS connectivity that brings the lock-in to your cell phone to advanced DSP filters that eliminate more noise while speeding up your experiment, the SR860 is truly the ultimate lock-in amplifier.

Signal Inputs

Lock-in performance starts at the front end. The SR860 front end offers both state-of-the-art voltage and current input amplifiers. The voltage input is a switchable single-ended/differential JFET-pair amplifier with 2.5 nV/ $\sqrt{\text{Hz}}$ of noise at 1 kHz and under 10 nV/ $\sqrt{\text{Hz}}$ of noise at 10 Hz. The voltage input has a 10 M Ω input impedance and can be AC or DC coupled. Input connector shields can be connected to the instrument ground through a user selectable 10 Ω (Ground) or 10 k Ω (Float) resistor.

SR860 500 kHz Lock-In Amplifier



SRS current source and several SRS preamplifiers

The SR860's built-in current amplifier represents a significant improvement over previous designs. The current input range is selectable from 1 μ A or 10 nA. The 1 μ A range has 400 kHz of bandwidth and 130 fA/ $\sqrt{\text{Hz}}$ of noise, while the 10 nA range offers 2 kHz of bandwidth and 13 fA/ $\sqrt{\text{Hz}}$ of noise.

While the built in voltage and current amplifiers are suitable for most applications, the SR860 is also compatible with the complete range of specialized pre-amplifiers offered by SRS. The SR550 (FET input), SR552 (BJT input), SR554 (transformer input), SR555 (120 kHz current amp), and SR556 (low-noise current amp) can all be powered directly from the SR860's rear-panel preamp power port. The SRS website shows you how each of these preamps can be used to optimize measurements in a wide variety of experimental situations.

Sensitivity and Input Range

As with previous instruments, the Sensitivity setting of the SR860 is the voltage (or current) which produces a full scale output. But unlike previous designs, the input range of the SR860 can be explicitly set from the front panel without having to consult a confusing "dynamic reserve" equation. Simply choose the sensitivity required by your experiment and then select the smallest input range that doesn't overload. That's it.

The SR860's effective dynamic reserve is simply the ratio of these two settings. For instance with a 10 nV sensitivity setting and a 300 mV input range the effective dynamic reserve of the SR860 is 3×10^7 , or nearly 150 dB.



Large numeric readout with strip chart recording

Output Time Constants and Filtering

The SR860 offers traditional RC-response output time constants from 1 μ s to 30 ks with rolloffs of 6, 12, 18, and 24 dB/oct. But in addition, the SR860 also offers advanced digital filters which can significantly reduce measurement time while increasing signal to noise. Below 3 s, the advanced filters are Gaussian FIR filters which at the same noise bandwidth as an RC filter have significantly better rise-time and stopband attenuation. These filters also have symmetric rise and fall profiles which preserves feature shapes while scanning in frequency. At time constants longer than 3 s, the advanced filters are linear phase IIR filters which settle nearly twice as fast as their RC counterparts for equivalent stopband attenuation.

Synchronous filtering may also be selected at reference frequencies below 4 kHz. The synchronous filter notches out multiples of the reference frequency and is extremely useful in making low frequency measurement where multiples of the reference frequency would otherwise show up in the lock-in output. Unlike previous designs the synchronous filter in the SR860 can be selected with no loss of output resolution.



SR540 Optical Chopper

Reference Channel

The SR860 has a specified reference frequency range of 1 mHz to 500 kHz. Detection can be done at the fundamental of the reference frequency, or at up to the 99th harmonic. Several reference modes are available: Internal mode uses the SR860's precision internal oscillator as the reference. External mode locks to an external sine or TTL signal. In Dual Mode, the lock-in detects at the difference frequency between the internally set reference frequency and an externally applied sync signal allowing direct recovery of a double-modulated signal. Finally, in Chop mode, the SR860 provides a digital PID (Proportional-Integral-Derivative) controller signal to synchronize an SR540 Optical Chopper to the internal oscillator of the lock-in. By having the lock-in directly control the chopper, frequency drift can be virtually eliminated.

Sine Output

The SR860 offers a precision sine wave output which can be set with 6 digits of frequency resolution and an amplitude range from 1 nV to 2 V. The SR860 output is unique in that it can be configured as a single-ended or as a differential (balanced) signal. A DC offset of up to ± 5 V can be applied

to the sine output. A rear-panel logic-level sync signal synchronized to the sine output is also provided.

Timebase

Rear-panel 10 MHz inputs and outputs are provided allowing the SR860 to be locked to an external frequency reference (such as the FS725 10 MHz Rubidium Frequency Standard). Alternatively, the 10 MHz output from the SR860 can be used to synchronize several lock-ins or other test equipment with a 10 MHz timebase input.

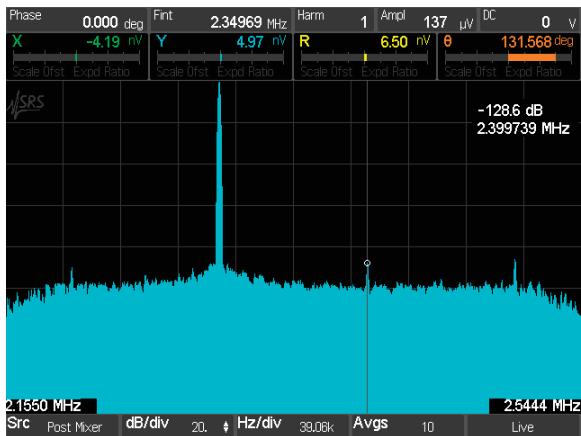

FFT display

FFT Displays

Lock-in amplifiers are traditionally time-domain instruments but sometimes it's easier to understand a signal in the frequency domain. The SR860 is at home in both worlds. An FFT display shows the spectrum of the input signal at the front end, the post-mixer signal, or the spectrum of the signal after the time-constant filters. Using the FFT displays can simplify tracking down sneaky noise sources that would otherwise get lost in the "one-number" output of a conventional lock-in amplifier.



Trend analysis

Front-Panel Touchscreen Display

The center of the SR860's front panel is a full-color 640 × 480 touchscreen which can be set to display up to 4 channels of data. (When a dark lab is required, the LCD screen can be blanked from the front panel or from the remote interface.) Each data channel can be configured to display X, Y, R, theta, Aux In (1-4), Aux Out (1-2), X noise, Y noise, Sine Amplitude, Sine Out DC Level, Reference Phase, or Reference Frequency. The screen can be set up to show the data channels as large numbers, easily visible from across the room, or as a "strip-chart" display showing a complete history of each channel with selectable time scales from 0.5 s/div to 2 days/div. Even when not displaying a measurement, all measurements are always being saved by the SR860 insuring that no data is ever lost. The touchscreen also continually displays key lock-in setup parameters such as phase, reference frequency, and sine amplitude. And a rear-panel HDMI port allows the LCD screen to be viewed on any HDMI monitor or TV.

It should be emphasized that as useful as the touchscreen display is for displaying data, it's not necessary to use the touchscreen to control common instrument functions on the SR860. All commonly used controls: time constant, reference frequency, sine amplitude and offset, input configuration, and more, are controllable with dedicated front panel knobs or buttons. Infrequently accessed configuration settings, such as the TCP/IP settings and other communication settings, are accessed through menus shown on the touchscreen.

Computer Connectivity

The SR860 comes standard with virtually every remote interface imaginable. GPIB (IEEE488.2) and RS-232 are of course provided, as well as USB (Test and Measurement Class) and Ethernet (VXI-11 and telnet). The SR860 hosts its own webserver allowing the instrument to be monitored and controlled remotely with just a browser. And when connected to a Wi-Fi enabled network, the SR860 can be controlled remotely from an iPhone or iPad with free iOS app downloadable from the Apple App Store. The app allows remote configuration of the instrument and monitoring of live data from your handheld device.

A front-panel USB port allows data and screen-shots to a USB flash drive. Data can be saved either as comma delimited files or MATLAB compatible .MAT files. Incorporating screen shots and data into reports or spreadsheets has never been easier.

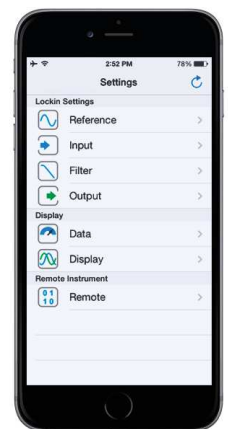

SR860 Specifications

Signal Channel

Voltage inputs	Single-ended or differential
Sensitivity (output scale)	1 nV to 1 V (voltage input) 1 fA to 1 μ A (current input)
Voltage input range	10 mV to 1 V (peak)
Current input range	1 μ A or 10 nA (peak)
Max input	1 V (peak) or 1 μ A (peak)
Input impedance	
Voltage input	10 M Ω + 25 pF, AC or DC coupled
Current input	1 k Ω or 100 Ω to virtual ground
Gain accuracy	$\pm 1\%$ (<200 kHz) Signal amplitude must be less than 30% of input range
Noise (rms)	2.5 nV/ $\sqrt{\text{Hz}}$ at 1 kHz (10 mV input range, typ.)
Harmonic distortion	-80 dB (<100 kHz), -60 dB (>100 kHz)
CMRR	90 dB to 1 kHz (DC coupled, 10 mV to 100 mV input range)
Dynamic reserve	120 dB (typ)

Reference Channel

Frequency range	0.001 Hz to 500 kHz
Timebase	10 MHz In/Out (phase locks the internal frequency to other SR860s)
Input impedance	1 M Ω or 50 Ω
Phase setting resolution	360/2 ³² degrees
Phase noise	
Int. ref	<0.0001° rms at 1 kHz (100 ms, 12 dB/oct)
Ext. ref (typ)	<0.001° rms at 1 kHz (100 ms, 12 dB/oct)
Phase drift (typ)	<0.002°/°C below 20 kHz (DC coupled) <0.02°/°C below 200 kHz <0.2°/°C below 2 MHz
Harmonic detection	Detect at $N \times f_{\text{ref}}$ ($N < 99$ and $(N \times f_{\text{ref}}) < 2 \text{ MHz}$)
Dual F reference	Detect at $f_{\text{dual}} = f_{\text{int}} - f_{\text{ext}} $
Chopper reference	SR860 drives SR540 Chopper (via Aux Out 4) to lock the chopper to f_{int}

Demodulator

DC stability	Digital output values have no drift
Time constants	1 μ s to 30 ks
Low pass filters	Typical RC-type filters or advanced Gaussian/Phase-Linear filters
Filter slope	6, 12, 18 or 24 dB/oct rolloff
Synchronous filter	Available below 4 kHz
Harmonic rejection	-80 dB
Low latency output	Rear-panel BlazeX output with <2 μ s delay (plus LPF rise/fall times).

Internal Oscillator

Frequency range	0.001 Hz to 500 kHz
Frequency accuracy	25 ppm + 30 μ Hz (with internal timebase)
External timebase	10 MHz timebase input/output (on rear panel)

Frequency resolution	6 digits or 0.1 mHz, whichever is greater
----------------------	---

Sine Output

Outputs	Single-ended or differential
Output impedance	50 Ω source
Amplitude	1 nVrms to 2 Vrms (amplitude is differential into 50 Ω loads). Output is halved when using in single-ended mode. Output is doubled when driving a high impedance load.
Amplitude resolution	3 digits or 1 nV, whichever is greater
DC offset	± 5 V, differential or common mode
Offset resolution	3 digits or 0.1 mV, whichever is greater
Output limit	± 6 V, sum of DC offset and peak amplitude
Sync	Logic level sync on rear panel (via BlazeX output)

Data

Data channels	Four data channels are displayed and graphed (green, blue, yellow, orange)
Data sources	Each data channel can be assigned any of these data sources: X, Y, R, θ , Aux In 1 to 4, Aux Out 1 to 2, X noise, Y noise, Sine Out Amplitude, Sine Out DC Level, Reference Phase, or Reference Frequency.
Data history	All data sources are continually stored at all chart display time scales. The complete stored history of any data source can be displayed at any time.
Offset	X, Y and R may be offset up to $\pm 999\%$ of the output scale
Expand	X, Y and R may be expanded by $\times 10$ or $\times 100$
Ratio	X and Y may be ratioed by Aux In 3. R may be ratioed by Aux In 4.
Capture buffer	1 Mpoint internal data storage. Store (X), (X and Y), (R and θ), or (X, Y, R and θ) at sample rates up to 1.25 MHz. This is in addition to the data histories for the chart display.
Data streaming	Realtime streaming of data, either (X), (X and Y), (R and θ), or (X, Y, R and θ) at sample rates up to 1.25 MHz over the Ethernet interface.
Scanning	One of the following parameters may be scanned: f_{int} , Sine Out Amplitude, Sine Out DC Level, Aux Out 1 or 2

FFT

Source	Input ADC, demodulator output, or filter output
Record length	1024 bins
Averaging	Exponential rms

SR860 Specifications

Inputs and Outputs

CH1 output	Proportional to X or R ($\pm 10\text{ V}$ full scale thru $50\ \Omega$)
CH2 output	Proportional to Y and θ ($\pm 10\text{ V}$ full scale thru $50\ \Omega$)
X and Y outputs	Proportional to X and Y (rear panel) ($\pm 10\text{ V}$ full scale thru $50\ \Omega$)
BlazeX	Low latency output of X, $\pm 2.0\text{ V}$ full scale or logic level reference sync output, either thru $50\ \Omega$
Aux outputs	4 BNC D/A outputs, $\pm 10.5\text{ V}$ thru $50\ \Omega$, 1 mV resolution
Aux inputs	4 BNC A/D inputs, $\pm 10.5\text{ V}$, 1 mV resolution, $1\text{ M}\Omega$ input
Trigger input	TTL input triggers storage into the internal capture buffer
Signal monitor	Analogue output of the signal amplifier
HDMI	Video output to external monitor or TV (640×480 , 60 Hz)
Timebase I/O	1 Vrms, 10 MHz clock to synchronize internal reference to other units

General

Interfaces	GPIB (IEEE-488.2), RS-232, USB and Ethernet
USB flash	Front-panel slot for USB flash storage of screen shots and data
Preamp power	9-pin D connector to power SRS preamps
Power	60 W, 100/120/220/240 VAC, 50/60 Hz
Dimensions	17" \times 5.25" \times 17" (WHD)
Weight	22 lbs.
Warranty	One year parts and labor on defects in materials and workmanship

Ordering Information

SR860	500 kHz lock-in amplifier	\$6495
SR550	Voltage preamplifier (100 M Ω , 3.6 nV/ $\sqrt{\text{Hz}}$)	\$750
SR552	Voltage preamplifier (100 k Ω , 1.4 nV/ $\sqrt{\text{Hz}}$)	\$750
SR554	Transformer preamplifier (0.091 nV/ $\sqrt{\text{Hz}}$)	\$1200
SR555	Current preamplifier	\$1095
SR556	Current preamplifier	\$1095
SR540	Optical chopper	\$1195

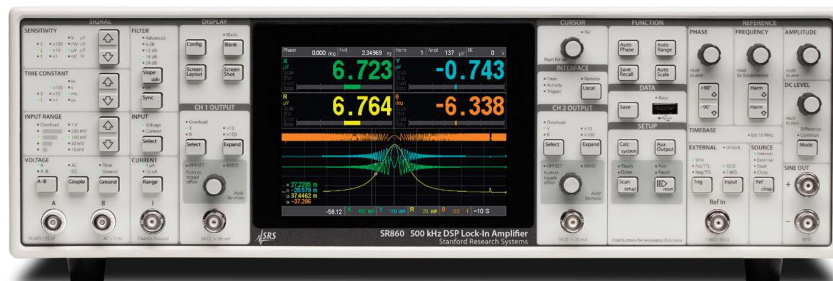

SR860 front panel



SR860 rear panel

Operation Manual

SR860 **500 kHz DSP Lock-in Amplifier**



Certification

Stanford Research Systems certifies that this product met its published specifications at the time of shipment.

Warranty

This Stanford Research Systems product is warranted against defects in materials and workmanship for a period of one (1) year from the date of shipment.

Service

For warranty service or repair, this product must be returned to a Stanford Research Systems authorized service facility. Contact Stanford Research Systems or an authorized representative before returning this product for repair.

Information in this document is subject to change without notice.
Copyright © Stanford Research Systems, Inc., 2016–2018. All rights reserved.
Stanford Research Systems, Inc.
1290-C Reamwood Avenue
Sunnyvale, California 94089
www.thinkSRS.com
Printed in U.S.A.

Document number 9-01714-903

Safety and Preparation for Use

Warning

Dangerous voltages, capable of causing injury or death, are present in this instrument. Use extreme caution whenever the instrument covers are removed. Do not remove the covers while the unit is plugged into a live outlet.

Line Voltage Selection

Caution

This instrument may be damaged if operated with the LINE VOLTAGE SELECTOR set for the wrong ac line voltage or if the wrong fuse is installed.

The SR860 operates from a 100V, 120V, 220V, or 240V nominal ac power source having a line frequency of 50 or 60 Hz. Before connecting the power cord, verify that the LINE VOLTAGE SELECTOR card, located in the rear panel fuse holder, is set so that the correct ac input voltage value is indicated by the white dot.

Conversion to other ac input voltages requires a change in the voltage selector card position and fuse value. See Appendix F (page 177) for detailed instructions.

Line Fuse

Verify that the correct line fuse is installed before connecting the line cord. For 100V/120V, use a 1 Amp fuse and for 220V/240V, use a 1/2 Amp fuse. See Appendix F (page 177) for detailed fuse installation instructions.

Line Cord

The SR860 has a detachable, three-wire power cord for connection to the power source and to a protective ground. The exposed metal parts of the instrument are connected to the outlet ground to protect against electrical shock. Always use an outlet which has a properly connected protective ground. Power Cord

Grounding

A chassis grounding lug is available on the back panel of the SR860. Connect a heavy duty ground wire, #12AWG or larger, from the CHASSIS GROUND lug directly to a facility earth ground to provide additional protection against electrical shock.

Grounded BNC shields are connected to the chassis ground. Do not apply any voltage to the grounded shields. The A and B signal input shields are connected to chassis ground through resistors and can tolerate up to 1 V of applied voltage.

GFCI (Ground Fault Circuit Interrupter)

GFCI protected outlets are often available in production and laboratory environments, particularly in proximity to water sources. GFCI's are generally regarded as an important defense against electrocution. However, the use of GFCI in conjunction with the SR860

must not be regarded as a substitute for proper grounding and careful system design. GFCI's must also be tested regularly to verify their functionality. Always consult an electrician when in doubt.

Service

Do not attempt to service this instrument unless another person, capable of providing first aid or resuscitation, is present.

Do not install substitute parts or perform any unauthorized modifications to this instrument. Contact the factory for instructions on how to return the instrument for authorized service and adjustment.

Warning Regarding Use With Photomultipliers and Other Detectors

The front end amplifier of this instrument is easily damaged if a photomultiplier is used improperly with the amplifier. When left completely unterminated, a cable connected to a PMT can charge to several hundred volts in a relatively short time. If this cable is connected to the inputs of the SR860 the stored charge may damage the front-end amplifier. To avoid this problem, always discharge the cable and connect the PMT output to the SR860 input before turning the PMT on.

Furnished Accessories

- Power Cord
- Operating Manual

Environmental Conditions

Operating









Temperature: +10 °C to +40 °C
(Specifications apply over +18 °C to +28 °C)

Relative Humidity: <90 % Non-condensing

Non-Operating

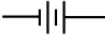
Temperature: -25°C to 65°C
Humidity: <95 % Non-condensing

Symbols you may Find on SRS Products

Symbol	Description
	Alternating current
	Caution - risk of electric shock
	Frame or chassis terminal
	Caution - refer to accompanying documents
	Earth (ground) terminal
	Battery
	Fuse
	On (supply)
	Off (supply)

Contents

Safety and Preparation for Use	i
Contents	v
SR860 Specifications	vii
SR860 Command List	x
SR860 Status Bytes	xv

Chapter 1 Getting Started 1

Introduction	1
SR860 Front Panel	2
SR860 Touchscreen	4
The Basic Lock-in	9
Using Displays	13
Sensitivity, Offset and Expand	20
Saving and Recalling Setups	25
Aux Outputs and Inputs	28
Scanning	30

Chapter 2 Lock-in Amplifier Basics 37

What is a Lock-in Amplifier?	37
What Does a Lock-in Measure?	40
Block diagram	41
The Reference Oscillator	42
The Phase Sensitive Detectors	43
Time Constants and Sensitivity	44
Outputs and Scales	46
What is Dynamic Reserve Really?	48
The Input Amplifier	50
Input Connections	51
Intrinsic (Random) Noise Sources	54
External Noise Sources	55
Noise Measurements	58

Chapter 3 Operation 61

Introduction	61
Standard Settings	64
Signal Input	65
CH1 and CH2 Outputs: Offset, Ratio and Expand	71
Reference	74
Display	81
Cursor	83

Functions 85
Interface and Data 87
Setup 88
Rear Panel 96

Chapter 4 Programming 101

Introduction 101
Command Syntax 103
Reference Commands 106
Signal Commands 111
CH1/CH2 Output Commands 114
Aux Input and Output Commands 116
Auto Function Commands 117
Display Commands 118
Strip Chart Commands 120
FFT Screen Commands 125
Scan Commands 128
Data Transfer Commands 132
Data Capture Commands 134
Data Streaming Commands 140
System Commands 143
Interface Commands 146
Status Reporting Commands 148
Status Byte Definitions 151

Appendix A Advanced Filters 155

Appendix B The FFT Display 161

Appendix C Using the Webserver 169

Appendix D Data Streaming and Capture 171

Appendix E Dual Reference Detection 175

Appendix F Fuse Installation and ac Line Select 177

Appendix G Performance Tests 181

Appendix H Circuit Description 201

SR860 Specifications

Signal Channel

Voltage Inputs	Single-ended (A) or differential (A–B)
Sensitivity (Output Scale)	1 nV to 1 V (voltage input) 1 fA to 1 μ A (current input)
Input Impedance	10 M Ω +25 pF, ac (>1 Hz) or dc coupled
Input Range	10 mV to 1 V (peak); max input before overload
Gain Accuracy	1% below 200 kHz and 2% to 500 kHz (signal amplitude <30% of input range)
Input Noise	2.5 nV/ $\sqrt{\text{Hz}}$ above 1 kHz, 10 mV input range (typical)
CMRR	Greater than 90 dB at 1 kHz (dc Coupled, 10 mV to 100 mV input range)
Harmonic Distortion	-80 dB below 100 kHz, -60 dB above 100 kHz
Dynamic Reserve	Greater than 120 dB
Current Input Ranges	1 μ A or 10 nA

Reference Channel

Frequency Range	1 mHz to 500 kHz
Timebase	10 MHz In/Out phase locks the internal frequency to other SR860 units
Ext TTL Reference	Minimum 2 V logic level, rising or falling edge
Ext Sine Reference	400 mV pk–pk minimum signal, ac coupled (>1 Hz)
Ext Reference Input Impedance	1 M Ω or 50 Ω
Acquisition Time	(2 cycles + 5 ms) or 40 ms, whichever is greater
Phase Setting Resolution	360/2 ³² deg
Phase Noise	Ext TTL reference: <0.001° rms at 1 kHz, (100 ms, 12 dB/oct) (typical) Internal reference: <0.0001° rms at 1 kHz (100 ms, 12 dB/oct)
Phase Drift	Sine Out to Signal In (200 mVrms) <0.002°/°C below 20 kHz (dc coupled input) <0.02°/°C below 200 kHz <0.2°/°C below 500 kHz
Harmonic Detect	Detect at $N \times f_{\text{ref}}$ where $N \leq 99$ and $N \times f_{\text{ref}} < 500$ kHz
Dual F Reference	Detect at $f_{\text{dual}} = f_{\text{int}} - f_{\text{ext}} $ All frequencies less than 500 kHz for specified performance
Chopper Reference	SR860 drives SR540 Chopper (via Aux Out 4) to lock the chopper to f_{int}

Demodulator

dc Stability	Digital output values have no offset drift
Time Constants	1 μ s to 30 ks
Low Pass Filters	Typical RC type filters or Advanced Gaussian/Linear Phase filters
Filter Slope	6, 12, 18, 24 dB/oct rolloffs
Synchronous Filter	Available below 4 kHz
Harmonic Rejection	-80 dB
Low Latency Output	Rear panel BlazeX output with <2 μ s delay (plus low pass filter rise/fall times)

Internal Oscillator

Frequency	1 mHz to 500 kHz
Frequency Accuracy	25 ppm + 30 μ Hz with internal timebase
External Timebase	10 MHz timebase input/output on rear panel
Frequency Resolution	6 digits or 0.1 mHz, whichever is greater

Sine Output

Outputs	Differential or Single-ended
Output Impedance	50 Ω source
Amplitude	1 nVrms to 2 Vrms (specified amplitude is differential into 50 Ω loads) Output amplitude is halved when used single-ended Output amplitude is doubled into a high impedance load
Amplitude Resolution	3 digits or 1 nV, whichever is greater
dc Offset	± 5 V, differential or common mode
Offset Resolution	3 digits or 0.1 mV, whichever is greater
Output Limit	± 6 V, sum of dc offset and peak amplitude
Sync	Logic level sync on rear panel (via BlazeX output)

Data

Data Channels	4 data channels are displayed and graphed (green, blue, yellow, orange)
Data Sources	Each data channel can be assigned any of these data sources: X, Y, R, θ , Aux In 1–4, Aux Out 1–2, X_{noise} , Y_{noise} , Sine Out Amplitude, Sine Out DC Level, reference phase, f_{int} or f_{ext}
Data History	All data sources are continuously stored at all chart display time scales. The complete stored history of any data source can be displayed at any time.
Offset	X, Y and R may be offset up to $\pm 999\%$ of the sensitivity
Ratio	X, and Y may be ratioed by Aux In 3; R may be ratioed by Aux In 4
Expand	X, Y and R may be expanded by $\times 10$ or $\times 100$
Capture Buffer	1 Mpoints internal data storage. Store (X), (X and Y), (R and θ) or (X, Y, R and θ) at sample rates up to 1.25 MHz. This is in addition to the data histories for the chart display.
Data Streaming	Realtime streaming of data, either (X), (X and Y), (R and θ) or (X, Y, R and θ) at sample rates up to 1.25 MHz over Ethernet interface
Scanning	One of the following parameters may be scanned: f_{int} , Sine Out Amplitude, Sine Out DC Level, Aux Out 1 or 2.

FFT

Source	Input ADC, demodulator output, or filter output
Record length	1024 bins
Averaging	exponential rms

Inputs and Outputs

CH 1 Output	Proportional to X or R, ± 10 V full scale thru 50 Ω
CH 2 Output	Proportional to Y or θ , ± 10 V full scale thru 50 Ω
X and Y Outputs	Proportional to X and Y, ± 10 V full scale thru 50 Ω , rear panel
BlazeX	Low latency output of X, ± 2.0 V full scale or logic level reference sync output, either thru 50 Ω
Aux Outputs	4 BNC D/A outputs, ± 10.5 V thru 50 Ω , 1 mV resolution
Aux Inputs	4 BNC A/D inputs, ± 10.5 V, 1 mV resolution, 1 M Ω input
Trigger Input	TTL input triggers storage into the internal capture buffer
Monitor Output	Analog output of the signal amplifier
HDMI	Video output to external monitor or TV, 640x480/60 Hz.
Timebase Input/Output	1 Vrms 10 MHz clock to synchronize internal reference frequency to other units

General

Interfaces	IEEE488, RS-232, USB device (Test and Measurement Class) and Ethernet (VXI-11 and telnet)
USB Flash	Front panel slot for USB flash storage of screen shots and data, and firmware upgrades
Preamp Power	9 pin D connector to power SRS preamps
Power	60 Watts, 100/120/220/240 VAC, 50/60 Hz
Dimensions	17"W x 5.25"H x 17"D
Weight	22 lbs
Warranty	One year parts and labor on materials and workmanship

SR860 Command List

Reference Commands	page	description
TBMODE(?) { AUTO INTERNAL I }	106	Set the 10 MHz timebase
TBSTAT?	106	Query the current 10 MHz timebase ext (0) or int (1)
PHAS(?) { p } { UDEG MDEG DEG URAD MRAD RAD }	106	Set the reference phase to p
APHS	106	Auto Phase
FREQ(?) { f } { HZ KHZ MHZ }	106	Set the reference frequency to f
FREQINT(?) { f } { HZ KHZ MHZ }	107	Set the internal reference frequency to f
FREQEXT?	107	Query the external reference frequency
FREQDET?	107	Query the detection frequency
HARM(?) { i }	107	Set harmonic detect to i
HARMDUAL(?) { i }	107	Set harmonic for dual reference mode to i
BLADESLOTS(?) { SLT6 SLT30 I }	108	Set the chopper blade number of slots
BLADEPHASE(?) { p } { UDEG MDEG DEG URAD MRAD RAD }	108	Set the chopper blade phase to p
SLVL(?) { v } { NV UV MV V }	108	Set sine output amplitude to v
SOFF(?) { v } { NV UV MV V }	108	Set sine output dc level to v
REFM(?) { COMMON DIFFERENCE I }	109	Set sine output dc mode
RSRC(?) { INT EXT DUAL CHOP I }	109	Set reference mode
RTRG(?) { SIN POSITIVE NEGATIVE I }	109	Set external reference trigger
REFZ(?) { 50ohms 1Meg I }	109	Set external reference input impedance
PSTF(?) [j] { , f { HZ KHZ MHZ } }	110	Set frequency preset j to f
PSTA(?) [j] { , v { NV UV MV V } }	110	Set sine amplitude preset j to v
PSTL(?) [j] { , v { NV UV MV V } }	110	Set sine dc level preset j to v

Signal Commands	page	description
IVMD(?) { VOLTage CURRent I }	111	Set input to voltage/current
ISRC(?) { A A-B I }	111	Set voltage input configuration
ICPL(?) { AC DC I }	111	Set voltage input coupling
IGND(?) { FLOat GROund I }	111	Set voltage input shield grounding
IRNG(?) { 1Volt 300Mvolt 100Mvolt 30Mvolt 10Mvolt I }	111	Set voltage input range
ICUR(?) { 1MEG 100MEG I }	112	Set current input gain
ILVL?	112	Query the signal strength low to overload (0–4)
SCAL(?) { I }	112	Set sensitivity from 1V (0) to 1 nV (27)
OFLT(?) { I }	113	Set time constant from 1 μ s (0) to 30 ks (21)
OFSL(?) { I }	113	Set filter slope from 6 dB (0) to 24 dB (3)
SYNC(?) { OFF ON I }	113	Turn synchronous filter off/on
ADVFLT(?) { OFF ON I }	113	Turn advanced filtering off/on
ENBW?	113	Query the equivalent noise bandwidth

CH1/CH2 Output Commands	page	description
COUT(?) [OCH1 OCH2 j] { , XY RTHeta i }	114	Set CH1/2 to (X or R)/(Y or θ)
CEXP(?) [X Y R j] { , OFF X10 X100 i }	114	Set CH1/2 expand
COFA(?) [X Y R j] { , OFF ON i }	114	Turn CH1/2 output offset off/on
COFP(?) [X Y R j] { , x }	114	Set CH1/2 output offset to x percent
OAUT [X Y R j]	114	Auto Offset CH1/2
CRAT(?) [X Y R j] { , OFF ON i }	115	Ratio Ch1/2 with Aux In 3 or 4

Aux Input and Output Commands	page	description
OAUX? [j]	116	Query Aux Input j (0–3)
AUXV(?) [j] { , v { NV UV MV V } }	116	Set Aux Output j (0–3) voltage to v

Auto Function Commands	page	description
APHS	117	Auto Phase
ARNG	117	Auto Range
ASCL	117	Auto Scale

Display Commands	page	description
DBLK(?) { OFF ON i }	118	Turn front panel blanking off/on
DLAY(?) { TREnd HISTory BARHist FFT BARFft BAREight i }	118	Set Screen Layout
DCAP	118	Screen Shot to USB memory stick
CDSP(?) [DAT1 DAT2 DAT3 DAT4 j] { , parameter i }	118	Assign parameter i to data channel j
CGRF(?) [DAT1 DAT2 DAT3 DAT4 j] { , OFF ON i }	119	Turn data channel j strip graph off/on
GETSCREEN?	119	Download screen capture image

Strip Chart Commands	page	description
GSPD(?) { i }	120	Set horizontal scale from 0.5 s (0) to 2 days (16)
GSCL(?) [DAT1 DAT2 DAT3 DAT4 j] { , x }	120	Set channel j vertical scale to x
GOFF(?) [DAT1 DAT2 DAT3 DAT4 j] { , x }	120	Set channel j vertical offset
GAUT [DAT1 DAT2 DAT3 DAT4 j]	121	Auto scale channel j
GACT [DAT1 DAT2 DAT3 DAT4 j]	121	Auto scale with zero center channel j
GAUF [DAT1 DAT2 DAT3 DAT4 j]	121	Auto find for channel j
CGRF(?) [DAT1 DAT2 DAT3 DAT4 j] { , { OFF ON i } }	121	Turn channel j graph off/on
GLIV(?) { OFF ON i }	122	Turn strip chart off/on (pause/run)
PCUR(?) { i }	122	Move cursor to i (0=right, 639=left)
CURREL(?) { OFF ON i }	122	Set cursor relative or absolute mode
CURDISP(?) { i }	122	Set cursor horizontal mode to date/time or interval
CURBUG(?) { AVG MAX MIN i }	122	Set cursor to mean / maximum / minimum
FCRW(?) { LIne NARrow WIde i }	123	Set the cursor width
SCRY? [DAT1 DAT2 DAT3 DAT4 STATus j]	123	Query the cursor data values
CURDATTIM?	123	Query the cursor horizontal position as date/time
CURINTERVAL?	124	Query the cursor horizontal position as interval

FFT Screen Commands	page	description
FFTR(?) { ADC MIXer FILTer i }	125	Set FFT data source
FFTS(?) { i }	125	Set vertical scale from 1.0 dB (0) to 200 dB (7)
FFTO(?) { x }	125	Set top reference level
FAUT	126	FFT auto scale
FFTMAXSPAN?	126	Query maximum allowed frequency span in Hz/div
FFTSPAN(?) { x }	126	Set frequency span in Hz/div
FFTA(?) { AVG1 AVG3 AVG10 AVG30 AVG100 i }	126	Set averaging
FFTL(?) { OFF ON i }	126	Turn FFT off/on (pause/live)
FCRW(?) { LIne NARrow WIde i }	126	Set the cursor width
FCRX?	127	Query the FFT cursor frequency
FCRY?	127	Query the FFT cursor amplitude

Scan Commands	page	description
SCNPAR(?) { Fint REFamp REFdc OUT1 OUT2 i }	128	Set the scan parameter
SCNLOG(?) { LIN LOG i }	128	Set the scan type
SCNEND(?) { ONce REpeat UPdown i }	128	Set the scan end mode
SCNSEC(?) { x }	128	Set the scan time to x seconds
SCNAMPATTN(?) { i }	128	Set the amplitude attenuator mode for scanning
SCNDCATTN(?) { i }	129	Set the dc attenuator mode for scanning
SCNINRVL(?) { i }	129	Set the scan parameter update interval
SCNENBL(?) { OFF ON i }	129	Turn the scan off/on
SCNRUN	130	Start or resume the scan
SCNPAUSE	130	Pause the scan
SCNRST	130	Reset the scan
SCNSTATE?	130	Query the scan (off, reset, run, pause or done)(0-4)
SCNFREQ(?) [BEGin END j] { , f { HZ KHZ MHZ } }	130	Set the begin/end frequency
SCNAMP(?) [BEGin END j] { , v { NV UV MV V } }	130	Set the begin/end reference amplitude
SCNDC(?) [BEGin END j] { , v { NV UV MV V } }	130	Set the begin/end reference dc level
SCNAUX1(?) [BEGin END j] { , v { NV UV MV V } }	131	Set the begin/end AuxOut1 value
SCNAUX2(?) [BEGin END j] { , v { NV UV MV V } }	131	Set the begin/end AuxOut2 value

Data Transfer Commands	page	description
OUTR? [DAT1 DAT2 DAT3 DAT4 j]	132	Query data channel j
OUTP? [j]	132	Query lock-in parameter j
SNAP? [j, k] { , l }	132	Query multiple lock-in parameters at once
SNAPD?	133	Query all 4 displayed parameters at once

Data Capture Commands	page	description
CAPTURELEN(?) { n }	136	Set the buffer length to n 1 kbyte blocks
CAPTURECFG(?) { X XY RT XYRθ i }	136	Configure capture to X, XY, Rθ or XYRθ (0–3)
CAPTURERATEMAX?	137	Query the maximum capture rate

CAPTURERATE(?) { n }	137	Set the capture rate to (max rate)/2 ⁿ
CAPTURESTART [ONEshot CONTinuous i], [IMMEDIATE TRIGstart SAMPpertrig j]	137	Start capture (OneShot or Cont) (HW trigger off/on)
CAPTURESTOP	138	Stop capture
CAPTURESTAT?	138	Query the capture buffer state
CAPTUREBYTES?	138	Query the number of bytes filled by captured data
CAPTUREPROG?	139	Query the length (kB) of captured data (after stop)
CAPTUREVAL? [n]	139	Query the n th sample (1, 2, or 4 values) (after stop)
CAPTUREGET? [i, [j]]	139	Download binary capture buffer

Data Streaming Commands

	page	description
STREAMCH(?) { X XY RT XYRT i }	140	Configure streaming to X, XY, R0 or XYR0 (0–3)
STREAMRATEMAX?	141	Query the maximum streaming rate
STREAMRATE(?) { n }	141	Set the streaming rate to (max rate)/2 ⁿ
STREAMFMT(?) { i }	141	Set the streaming format to float32 (0) or int16 (1)
STREAMPCKT(?) { i }	141	Set packet size to 1024, 512, 256 or 128 bytes (0–3)
STREAMPORT(?) { i }	142	Sets the Ethernet port to i=1024–65535
STREAMOPTION(?) { i }	142	Sets big/little endianness and integrity checking
STREAM(?) { OFF ON i }	142	Turn streaming off/on

System Commands

	page	description
TIME(?) [SEcOnDs MINutes HOuRs j] { , i }	143	Set time
DATE(?) [DAY MONTH YEAr j] { , i }	143	Set date
TBMODE(?) { AUTO INteRnal i }	143	Set the 10 MHz timebase
TBSTAT?	143	Query the current 10 MHz timebase ext (0) or int (1)
BLAZEX(?) { BLazex BIsync UNIsync i }	143	Select the BlazeX output
KEYC(?) { ON MUte i }	144	Turn sounds on or off
PRMD(?) { SCReen PRNt MONOchrome i }	144	Set screen shot mode
SDFM(?) { CSV MATfile i }	144	Set data file type
FBAS(?) { s }	144	Set file name prefix
FNUM(?) { i }	144	Set file name suffix
FNXT?	145	Query next file name
DCAP	145	Screen shot
SVDT	145	Save data

Interface Commands

	page	description
*RST	146	Reset the unit to its default configuration
*IDN?	146	Query the unit identification string
*TST?	146	No-op, returns “0”
*OPC(?)	146	Operation Complete
LOCL(?) { i }	146	Set LOCAL (0), REMOTE (1) or LOCKOUT (2)

xiv Commands

OVRM (?) { OFF | ON | i } 147 Set GPIB Override Remote off (0) or on (1)

Status Reporting Commands

	page	description
*CLS	148	Clear all status bytes
*ESE(?) { j, } { i }	148	Set the standard event enable register
*ESR? { j }	148	Query the standard event status byte
*SRE(?) { j, } { i }	148	Set the serial poll enable register
*STB? { j }	148	Query the serial poll status byte
*PSC(?) { i }	149	Set the Power-On Status Clear bit
ERRE(?) { j, } { i }	149	Set the error status enable register
ERRS? { j }	149	Query the error status byte
LIAE(?) { j, } { i }	149	Set LIA status enable register
LIAS? { j }	150	Query the LIA status word
CUROVLDSTAT?	150	Query the present overload states

SR860 Status Bytes

Serial Poll Status Byte

bit	name	usage
0		unused
1		unused
2	ERR	An enabled bit in the error status byte has been set
3	LIA	An enabled bit in the LIA status byte has been set
4	MAV	The interface output buffer is non-empty
5	ESB	An enabled bit in the standard status byte has been set
6	SRQ	SRQ (service request) has occurred
7		unused

Standard Event Status Byte

bit	name	usage
0	OPC	Operation complete
1	INP	Input queue overflow
2		unused
3	QRY	Output queue overflow
4	EXE	A command cannot execute correctly or a parameter is out of range
5	CMD	An illegal command is received
6	URQ	Set by any user front panel action
7	PON	Set by power-on

LIA Status Word

bit	name	usage
0	CH1OV	CH1 output overload
1	CH2OV	CH2 output overload
2		unused
3	UNLK	External reference or Chop unlock detected
4	RANGE	Input range overload detected
5	SYNCF	Sync filter frequency out of range
6	SYNCOV	Sync filter overload
7	TRIG	Set when data storage is triggered
8	DAT1OV	Data Channel 1 output overload
9	DAT2OV	Data Channel 2 output overload
10	DAT3OV	Data Channel 3 output overload
11	DAT4OV	Data Channel 4 output overload
12	DCAPFIN	Display capture to USB stick completed
13	SCNST	Scan started
14	SCNFIN	Scan completed

Error Status Byte

bit	name	usage
0	CLK	External 10 MHz clock input error
1	BACKUP	Battery backup failed
2		unused
3		unused
4	VXI	VXI-11 error
5	GPIB	GPIB fast data transfer mode aborted
6	USBDEV	USB device error (interface error)
7	USBHOST	USB host error (memory stick error)

Chapter 1

Getting Started

Introduction

The sample measurements described in this section are designed to acquaint the first time user with the SR860 DSP Lock-In Amplifier. Do not be concerned that your measurements do not exactly agree with these exercises. The focus of these measurement exercises is to learn how to use the instrument. It is highly recommended that the first time user step through some or all of these exercises before attempting to perform an actual experiment.

Keys, Knobs and Touch Buttons

- [Key] Front panel keys are referred to in [square] brackets. Some keys have a second italicized label. Press and hold these keys for 2 seconds to invoke the italicized function.
- <Knob> Knobs are referred to in <angle> brackets. Knobs are used to adjust parameters which have a wide range of values. Some knobs have a push button function. Some also have a second italicized label. Press and hold these knobs for 2 seconds to invoke the italicized function.
- {Touch} Touchscreen buttons and icons are referred to in {curly} brackets. Touchscreen buttons are used to adjust the data display as well as change certain lock-in parameters.

SR860 Front Panel

The SR860's buttons and knobs are mainly used to configure the lock-in measurement, while the touchscreen is mainly for data display. The touchscreen display is also used for keypad entry.

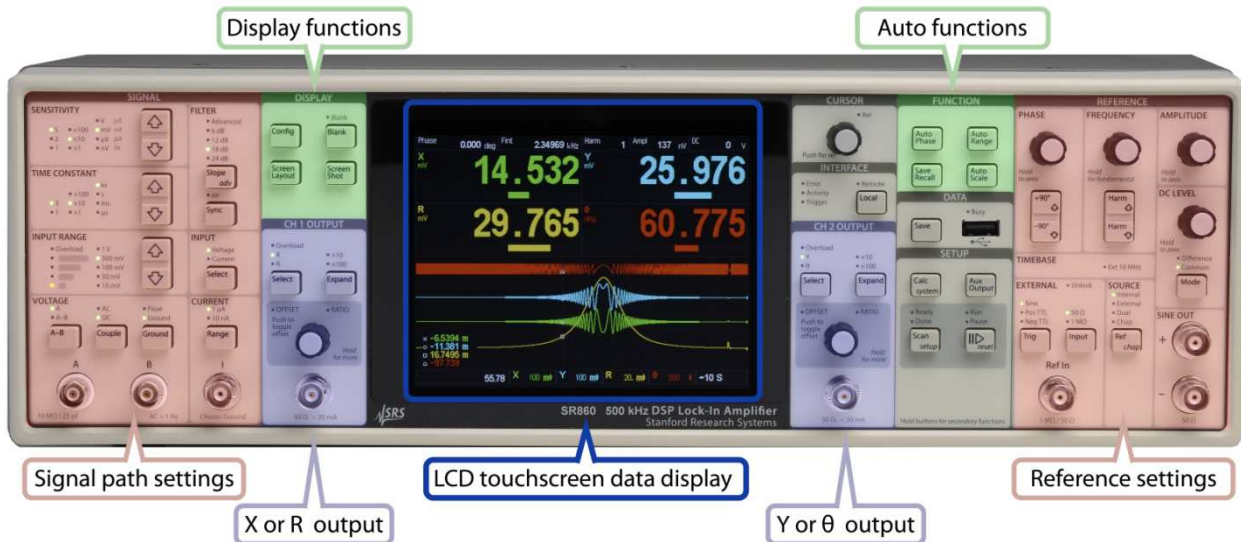

Signal Path

The signal path settings configure input BNC's, input gain, time constant and filters and the sensitivity. Unlike previous generation lock-ins, the SR860 does not have a dynamic reserve setting. The input range setting is simply the largest input signal before overload. It is best to decrease the input range setting as much as possible without overload. This increases the gain and utilizes more of the A/D converter's range as indicated by the signal strength LEDs.

The sensitivity determines the scale factor for the analog outputs (CH1 and CH2) as well as the numeric readouts and bar graphs. The sensitivity does *not* affect the measurement values, it simply determines how much signal corresponds to a full scale 10V output from CH1 and CH2 outputs and a 100% bar graph. It also sets the scale for the 5 digit numeric displays. The sensitivity should be viewed as an output function only.

Reference

The reference settings configure the lock-in reference frequency and source. In addition to internal and external reference, the SR860 includes dual reference (detect at $|f_{\text{int}} - f_{\text{ext}}|$) and chop (lock an SR540 chopper TO the SR860 f_{int}) modes.

The SR860 can be synchronized to an external 10 MHz frequency reference (from another SR860 or other source). This allows multiple SR860's to run in phase sync with each other in internal reference mode.

The sine output from the SR860 is differential. This provides improved performance at low amplitudes. A variable dc offset is provided in both differential and common mode. Use either sine out for single ended excitation.

Outputs

The CH1 output can be proportional to either X or R, while the CH2 output can be proportional to Y or θ . Output functions include offset (up to $\pm 999\%$ of the sensitivity), expand (up to $\times 100$) and ratio. These functions are generally only used when the CH1 or CH2 outputs are being used to drive other parts of an experiment.

SR860 Touchscreen

The SR860 screen displays the lock-in outputs both numerically and graphically. Touch buttons and icons are used to adjust the data displays as well as enter certain lock-in parameters.

Screen Layout

Press [Screen Layout] to cycle through the different screen layouts.



Trend Graph

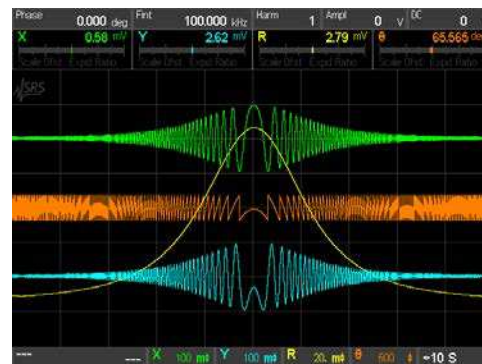

Full Screen Strip Chart



Half Screen Strip Chart



Full Screen FFT



Half Screen FFT



Big Numbers

The SR860 displays up to 4 channels at a time, in green, blue, yellow and orange. Each channel is assigned a parameter using the [Config] key. Parameters are chosen from X,

Y, R, θ (detected), f_{int} , f_{ext} , phase (setting), Sine Amplitude, DC Level, any Aux Input, Aux Output 1 or 2, Xnoise, or Ynoise.

Displayed parameters can be re-assigned at any time. Data is being stored for all possible parameters all of the time.

Info Bar and Numeric Entry

Each of the data screens always displays a lock-in info bar across the top.

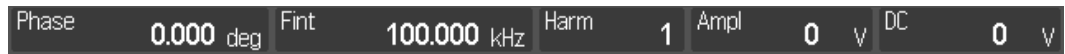

This bar always shows tiles displaying the phase, frequency, detect harmonic, sine out amplitude and dc offset of the sine out. Each of these parameters can be adjusted using the knobs and buttons in the reference settings section of the front panel.

Touching one of these tiles brings up a numeric keypad for direct entry.

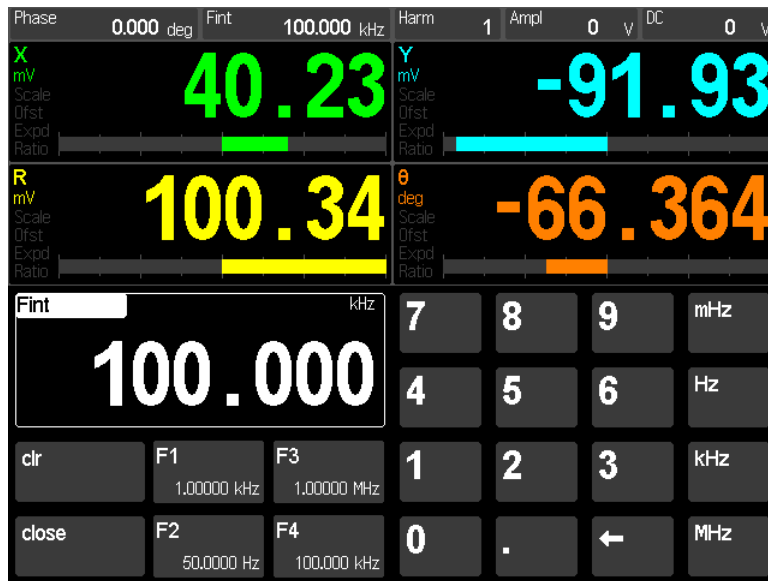

Internal frequency entry screen

Numeric entry is straightforward. {Close} will return to the data screen. The buttons {F1}, {F2}, {F3} and {F4} are frequency presets. Touching a preset will load the preset value immediately. Touch and hold a preset button to memorize the current setting. Other parameters may have slightly different entry screens.

Strip Charts

The most common way to visualize the lock-in outputs is to use the strip chart display. New data is plotted at the right edge and older data scrolls left. The scroll rate is determined by the horizontal scale (time per division). For example, a scale of 1s/div presents the 10 most recent seconds of data and data points take 10 s to scroll completely off the left edge. Horizontal scales range from 0.5 s to 2 days per division.

At each point along the horizontal axis, the graph displays the maximum to minimum excursion of each data channel during a time interval corresponding to that point in the

past. The time interval is determined by the horizontal scale per division and the number of pixels in the display. There are 640 pixels across 10 divisions of the graph. Thus there are 64 pixels in each division. At a scale of 0.5 s/div, each pixel represents about 8 ms of data. At a scale of 1 min/div, each pixel represents about 1 s of data. This ‘binning’ is fundamental to the SR860 strip chart display. All time scales are stored all of the time. This allows the horizontal scale to change without re-acquiring any data. The caveat is that all graphs are drawn with the most recent point at the right hand edge.

Zooming in and out (changing the horizontal scale) always displays the most recent point at the right edge. There is no zooming in about a point in the distant past.

All parameters which may be assigned to a data channel are continuously recorded even when they are not displayed. This means that historical data can be viewed for all parameters simply by assigning them to a data channel and viewing the strip chart.

Strip charts may be paused. When the graph is paused, the cursor can be used to readout data values. Data storage continues in the background while the graph is paused. When live scrolling is resumed, the graph is redrawn so the most recent point is once again at the right edge.

Graph Scale Bar

Strip Chart displays have a scale bar at the bottom of the screen.

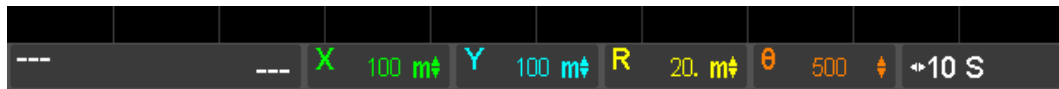

This bar shows tiles indicating the vertical scale per division for the 4 data channels (green, blue, yellow and orange) and the horizontal time scale per division (white).

Touch a data channel’s scale tile to display a palette of scale functions.



Chart vertical scale palette

Use the palette functions to scale the selected data channel's graph. Touch the scale tile again to dismiss the palette.

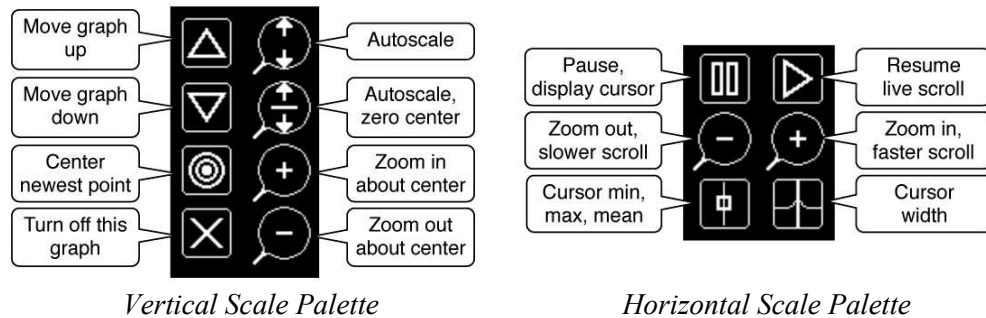

Vertical Scale Palette

Horizontal Scale Palette

Vertical Scale Palette

Vertical scale changes are applied to each data channel separately. {Autoscale} adjusts the scale and center so the graph occupies as much of the screen as possible. {Autoscale Zero Center} forces the center of the graph to be zero and then sets the scale to show the data. The location of zero is indicated by the small triangle on the right edge. It points left where zero is. It points up or down if zero is above or below the graph.

{Zoom In} and {Zoom Out} change the scale about the center. Use {Center Newest Point} to bring the current point to the center of the graph before zooming in or out. {Move Up} and {Move Down} simply move the graph up and down on the screen. The graph can also be moved simply by touching and dragging on the screen while the vertical scale palette is displayed.

Each graph can also be turned off. Touch the scale tile to turn the graph back on.

All changes to the graphs are non-destructive. They simply change the way data is visualized. Stored parameter values are not altered by scale changes.

Horizontal Scale Palette

Horizontal scale changes are applied to the entire strip chart display and all data channels.

{Zoom In} and {Zoom Out} change the horizontal scale and scroll speed.

{Pause} stops the chart scrolling and pauses the graph. When the graph is paused, the cursor can be used to readout data values. These readouts correspond to the min, max or mean of the data in the time bin at the cursor location. The time of the cursor location is displayed in the tile at the left edge of the scale bar below the graph. Touch this tile to switch between elapsed time from the right edge to absolute time (time and date when the point was taken). Use {Cursor MinMaxMean} and {Cursor Width} to change the cursor. Note that the cursor marker may not lie on the data graph for wide cursors since the marker shows the min, max or mean of *all* the data within the cursor width.

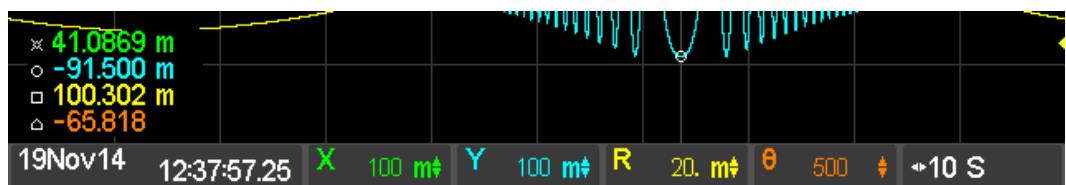

The cursor is only displayed when the graph is paused.

Zooming in and out preserves the right hand edge of the graph at the point in time when the graph was paused.

Data storage continues in the background while the graph is paused. When live scrolling is resumed with {Resume}, the graph is redrawn so the current point is once again at the right edge.

The Basic Lock-in

This measurement is designed to use the internal oscillator to explore some of the basic lock-in functions. Specifically, you will measure the amplitude of the Sine Out at various frequencies, amplitudes, time constants and phase shifts.

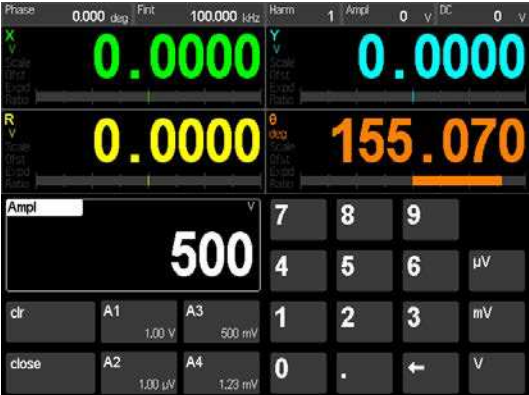
Do This	Explanation
<ol style="list-style-type: none"> 1. Disconnect all cables from the lock-in. Turn the power on while holding down the [Local] key. The power switch is on the power entry module on the rear panel. 	<p>When the power is turned on with [Local] pressed, the lock-in returns to its standard default settings. See the Standard Settings list in the Operation section for a complete listing of the settings.</p>
<ol style="list-style-type: none"> 2. Connect the Sine Out + on the front panel to the A input using a BNC cable. 	<p>The lock-in defaults to the internal oscillator reference set at 100.000 kHz. The reference source is indicated by the Internal LED. In this mode, the lock-in generates a synchronous sine output at the internal reference frequency.</p> <p>The default data screen is the Trend Graph. The 4 displayed parameters default to X, Y, R and θ. Each parameter has a numeric display, a bar graph and a trend graph. The trend graph is a continuously autoscaling graph of the recent history of each parameter. This data screen has no adjustments available.</p> <p>The default sine amplitude is 0 Vrms. Thus the data displays will read 0 for X, Y and R. θ will be just noise.</p>
<ol style="list-style-type: none"> 3. Touch {Ampl} in the info bar along the top of the screen. Then {5}{0}{0}{mV}. 	<p>The lock-in parameters shown in the info bar at the top of the screen may be entered using a numeric keypad simply by touching them.</p> <p>The Sine Out amplitude is specified for differential output (Sine+) – (Sine–). In this case, each BNC has an amplitude of 250 mV (rms) with a 50Ω output. The lock-in input is high impedance so the output of each BNC is doubled and the lock-in measures 500 mV.</p>
<ol style="list-style-type: none"> 4. Press the [Auto Phase] key. 	<p>Since the phase shift of the sine output is very close to zero, X (green) should read about 0.5000 and Y (blue) should read close to 0.0000 V.</p> <p>Automatically adjust the reference phase shift to eliminate any residual phase error. This should set the values of Y and θ to zero.</p>

5. Press the [+90°] key.

Use the <Phase> knob to adjust the phase shift back to zero (press and hold the <Phase> knob inward as a short cut). The Phase shift is displayed in the info bar at the top of the screen.

6. Touch {Fint} in the info bar.



Touch {1}{0}{kHz} to enter a new frequency.

Use the <Frequency> knob to adjust the frequency to 1.00000 kHz.

7. Use the <Amplitude> knob to adjust the sine out to 5.0 mV. The Amplitude is displayed in the info bar.
8. Press [Auto Range].

This adds 90° to the reference phase shift. The value of X drops to zero and Y becomes minus the magnitude (-0.5000 V).

The lock-in parameters shown in the info bar, Phase, Reference Frequency, Detected Harmonic, Sine Amplitude and Offset, can all be adjusted from the front panel as well as via a touchscreen keypad.

Display the numeric entry screen for internal reference frequency. The 4 buttons labelled {F1} thru {F4} are frequency presets. Press and hold them to memorize new frequencies.

Change the frequency to 10 kHz.

The knob is very useful for making small adjustments or optimizing a setting. Large changes are better left to the numeric keypad.

The measured signal amplitude X and R should stay within 1% of 500 mV and Y and θ should stay close to zero.

As the amplitude is changed, the values of X and R change to follow.

The yellow LED in the Input Range section should light. The Input Range is the largest input signal before overload. The lower the range, the higher the gain. The signal strength indicates how much of the A/D converter range is being used. When the yellow indicator lights, it means that more gain should be used.

Since the signal has just been reduced by a factor of 100, the input range should be adjusted as well.

The Auto Range function changes the Input Range to maximize the signal at the A/D

9. Use the <Amplitude> knob to increase the sine out to 50.0 mV. The Amplitude is displayed in the info bar.
10. Press [Auto Range].

Press [Auto Range] again.
11. Press [Input Range Down] to select 30 mV.

Press [Input Range Up] to select 100 mV.
12. Press [Sensitivity Down] multiple times to select 50 mV.
13. Press [Time Constant Down] multiple times to select 300 μ s.

converter without overload. In this case the Input Range should change to 10 mV.

The Input Range is the peak allowable voltage at the input, whether noise or signal. In this case, the signal is 5 mVrms or 7 mVpk so 10 mV is the best allowed setting.

The signal strength increases from the minimum (yellow) to something in the middle.

The peak signal exceeds the input range so the Input Range **Overload** LED lights. Ovld indicators also appear on the screen when a displayed value has an input overload.

During Input Range Overload, the Auto Range function selects the 1 V range.

From the 1 V range, the Auto Range function changes the Input Range to maximize the signal at the A/D converter without overload. The Input Range should change to 100 mV.

Settings which have many options, such as Input Range, Time Constant and Sensitivity, are changed with up and down keys. The setting is indicated by LEDs.

The peak signal exceeds the input range so the Input Range **Overload** LED lights. Ovld indicators also appear on the screen when a displayed value has an input overload.

The Sensitivity is indicated with 3 LEDs. In this case, the **5**, **$\times 10$** and **mV** should be lit.

The Sensitivity sets full scale for the bar graphs and the resolution for the numeric readouts for X, Y and R. Sensitivity is also the signal reading corresponding to 10 V on the CH1 and CH2 outputs (for X, Y and R).

By decreasing the scale value, the bar graphs and numeric readings display much more resolution for the smaller signal.

The Time Constant is indicated with 3 LEDs. In this case, the **3**, **$\times 100$** and **μ s**.

14. Press [Slope] to select 12 dB/oct.

Press [Slope] twice more to select 24 dB/oct.

Press [Slope] again to select 6 dB/oct.

15. Press [Sync] to turn on synchronous filtering.

The output values become noisy. This is because the $2f$ component of the output (at 2 kHz) is no longer attenuated completely by the low pass filter.

The red Output **Overload** LED for CH1 will light indicating that the output voltage is clipping. The 50 mV signal outputs 10 V when the sensitivity is 50 mV. The large additional $2f$ component will cause the output to try and exceed 10 V and results in an output overload. Output overload does not affect the actual displayed value, it just indicates that the CH1 (or CH2) output is not following the measured value.

Parameters which have only a few values, such as Filter Slope and External Source, have only a single key which cycles through all available options. Press the key until the desired option is indicated by an LED.

The outputs are less noisy with 2 poles of filtering.

With 4 poles of low pass filtering, even this short time constant attenuates the $2f$ component reasonably well and provides steady readings.

Let's leave the filtering short and the outputs noisy for now.

This turns on synchronous filtering whenever the detection frequency is below 4.8 kHz.

Synchronous filtering effectively removes output components at multiples of the detection frequency. At low frequencies, this filter is a very effective way to remove $2f$ without using extremely long time constants.

The outputs are now quiet and steady, even though the time constant is very short. The response time of the synchronous filter is equal to the period of the detection frequency (1 ms in this case).

This concludes this measurement example. You should have a feeling for the basic operation of the front panel. Basic lock-in parameters have been introduced and you should be able to perform simple measurements.

Using Displays

This measurement is designed to use the internal oscillator and an external signal source to explore some of the display types. You will need a synthesized function generator capable of providing a 500 mVrms sine wave at 100.000 kHz, BNC cables and a terminator appropriate for the generator function output.

Specifically, you will display the lock-in outputs when measuring a signal close to, but not equal to, the internal reference frequency. This setup ensures changing outputs which are more illustrative than steady outputs.

Do This	Explanation
<ol style="list-style-type: none"> 1. Disconnect all cables from the lock-in. Turn the power on while holding down the [Local] key. The power switch is on the power entry module on the rear panel. 2. Turn on the function generator, set the frequency to 100.000 kHz (exactly) and the amplitude to 500 mVrms. Connect the function output (sine wave) from the synthesized function generator to the A input using a BNC cable and appropriate terminator. 	<p>When the power is turned on with [Local] pressed, the lock-in returns to its standard default settings. See the Standard Settings list in the Operation section for a complete listing of the settings.</p> <p>The input impedance of the lock-in is 10 MΩ. The generator may require a terminator. Many generators have either a 50Ω or 600Ω output impedance. Use the appropriate feedthrough or T termination if necessary. In general, not using a terminator means that the function output amplitude will not agree with the generator setting.</p>
	<p>The default screen is the Trend Graph. Four data channels are displayed as values, bar and trend graphs. The trend graph is the recent history of each data channel with continuous auto-scaling. In this case R (yellow) auto scales to show the tiny amount of noise in the signal magnitude. Trend graphs have no adjustments and are most useful when adjusting an experiment to find a maximum or minimum.</p> <p>The lock-in defaults to the internal oscillator reference set at 100.000 kHz. The reference source is indicated by the Internal LED.</p> <p>The internal oscillator should be very close to the actual generator frequency. The X (green) and Y (blue) displays should read values which change slowly. The lock-in and the generator are not phase locked but they are at (nearly) the same frequency with a slowly changing θ (orange). The signal magnitude R (yellow) is phase independent and does not change.</p>

- Use the <Frequency> knob to carefully adjust the frequency to 99.9998 kHz. That's 0.2 Hz below 100 kHz.

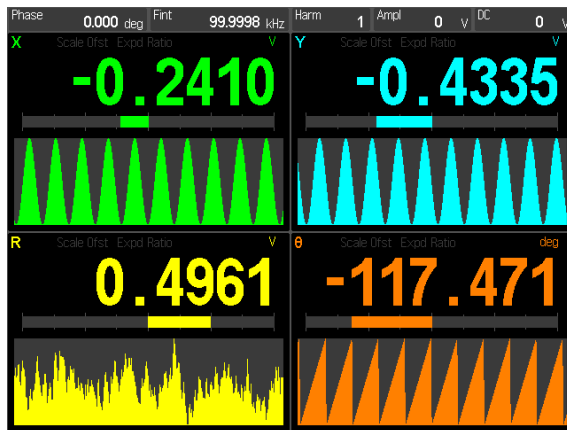

- Press [Screen Layout] once to change the display to the full screen strip chart.



- Touch the orange scale tile {θ} at the bottom to display the vertical scale palette.



By setting the lock-in reference 0.2 Hz away from the signal frequency, the X and Y outputs are 0.2 Hz sine waves (difference between f_{ref} and f_{sig}). The X and Y displays should now oscillate at about 0.2 Hz (the accuracy is determined by the timebases of the generator and the lock-in).

The most common way to visualize the lock-in outputs is to use the strip chart display. New data is plotted at the right edge and older data scrolls left. The scroll rate is determined by the horizontal scale (time per division). The fastest rate is 0.5 s/div and the shows 5 s of history.

The info bar is at the top of the screen. Touch a tile to change a parameter using a keypad.

The numeric and bar graph displays shrink to fit above the chart.

The scale bar is shown below the strip chart. This bar shows tiles indicating the vertical scale per division for the 4 data channels (green, blue, yellow and orange) and the horizontal time scale per division (white).

Use the palette functions to adjust the vertical scale of the selected data channel's trace. Touch the scale tile again to dismiss the palette.

The trace may be moved up and down, auto scaled, zoomed in and out and dismissed entirely.

Touch  to auto scale the orange θ graph.



6. Touch the green scale tile {X} to display its scale palette.

Touch  to auto scale the green X trace.

7. Touch the blue scale tile {Y} to display its scale palette.



Touch  to auto scale the blue Y trace.

8. Touch the yellow scale tile {R} to display its scale palette.

Touch  to move the trace so the newest points are vertically centered.

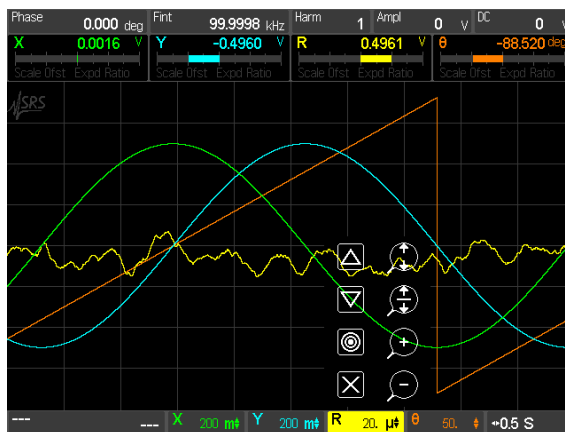
Touch  repeatedly to zoom in about the center. Keep zooming in until the yellow trace shows some noise. The scale will probably end up less than 1 mV.



Touch  to auto scale a trace. Touch  to auto scale while keeping zero in the center.

The phase is ramping from -180° to $+180^\circ$ so the resulting scale is 50/div for a graph of $\pm 200^\circ$.

Touch the orange scale tile again to dismiss the scale palette.

Selecting a scale tile automatically dismisses any other palette.

Touch a highlighted scale tile to simply dismiss its palette leaving all palettes off.

The X and Y outputs are 0.2 Hz sine waves with 500 mV amplitudes.

The magnitude R is phase independent and is a straight flat line at about 500 mV.

By centering the trace, the zoom function will expand the trace to reveal noise on R.

The little triangles along the right edge indicate the zero for each data channel. Zooming in on R moves the zero for R below the graph as indicated by the downward facing yellow triangle at the bottom right edge.

9. Touch and drag in the graph area while the yellow scale palette is displayed to move the yellow trace up and down.

10. Touch the highlighted yellow scale tile {R} to dismiss its scale palette.

Now touch anywhere within the graph area.



Touch anywhere within the graph area to dismiss the status display.

11. Touch the white scale tile {Time} to display the horizontal scale palette.

Touch  repeatedly to zoom out.

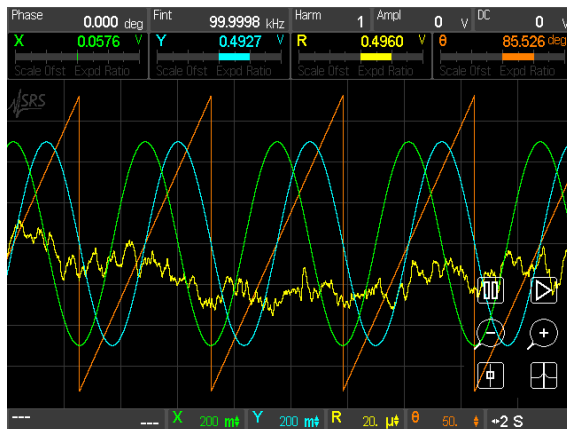

12. Increase the amplitude of the function generator to 1.5 Vrms.

When a trace is selected (by displaying its scale palette) touching anywhere inside the graph area (and not a scale button) drags the trace up and down.

The  and  buttons also move the trace up and down.

Touching within the graph area when no trace is selected turns on a status display across the top of the graph. This displays the lock-in signal settings.

This status is useful when the HDMI port (on the rear panel) is used to drive an external monitor or TV. Users who are looking at the monitor can see the lock-in front panel settings.

The status display is dismissed when the graph area is touched or a scale palette is displayed. Simply turn it back on with a touch if desired.

Horizontal scale changes are applied to the entire strip chart display and all data channels.

Zooming changes the horizontal scale and scroll speed. The chart always displays the most recent point at the right edge.

In this case, zooming out displays more history and more cycles of X, Y and θ appear.

The signal now exceeds the input range of 1 V (peak) so the Input Range **Overload** LED is on. 'Ovld' indicators are displayed for X, Y, R and



Decrease the amplitude of the function generator back to 500 mVrms.

13. Touch the white scale tile {Time} to display the horizontal scale palette.

Touch  repeatedly to zoom out.

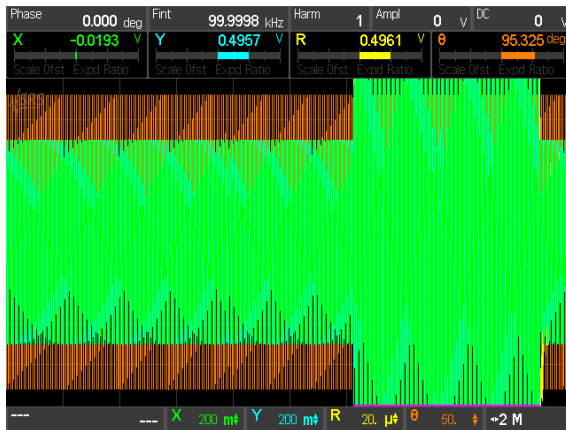

Touch  repeatedly to zoom back in.

14. Press [Screen Layout] once to change the display to the half screen strip chart.

θ because these values are affected by signal overload.

Conditions such as overload or reference unlock are displayed in violet along the bottom. This provides visual feedback about the validity of the data in those regions.

The overload condition goes away.

Zoom out on the horizontal time scale to show more and more history. When the region where the signal was overloaded is shown, the overload is indicated by the violet points along the bottom edge.

The half screen strip chart behaves the same as the full screen version. The only difference is that the numeric and bar graphs are full sized.



- Press [Screen Layout] again to change the display to the full screen FFT.

The FFT of the signal input is displayed. There is only a single quantity shown.



The left and right edge frequencies are labelled at the bottom of the graph. The cursor readout is at the right.

The display is adjusted with the tiles across the bottom. {Src} selects the source data for the FFT. {dB} and {Hz} adjust the vertical and horizontal scales. {Avgs} sets the amount of averages and {Live} toggles to {Paused}.

Use the <Cursor> knob to move the cursor.

- Press [Screen Layout] again to change the display to the half screen FFT.

The half screen FFT display behaves the same as the full screen version. The only difference is that the numeric and bar graphs are full sized.

- Press [Screen Layout] again to change the display to the full numeric display.

The full numeric screen adds readouts and bar graphs for the 4 aux inputs on the rear panel. The 4 aux outputs are shown in tiles across the bottom. Touching an output tile displays a keypad to set the aux output.



18. Press [Screen Layout] again to cycle back to the trend graph.

Use [Screen Layout] to cycle through the various display screens.

This concludes the measurement example. You should have a feeling for the basic operation of the display screens.

Sensitivity, Offset and Expand

This measurement is designed to use the internal oscillator to explore some of the basic lock-in outputs. You will need BNC cables and a digital voltmeter (DVM).

Specifically, you will measure the amplitude of the Sine Out and provide analog outputs proportional to the measurement. The effect of offsets and expands on the displayed values and the analog outputs will be explored.

- | Do This | Explanation |
|---|--|
| 1. Disconnect all cables from the lock-in. Turn the power on while holding down the [Local] key. The power switch is on the power entry module on the rear panel. | When the power is turned on with [Local] pressed, the lock-in returns to its standard default settings. See the Standard Settings list in the Operation section for a complete listing of the settings. |
| 2. Connect the Sine Out + on the front panel to the A input using a BNC cable. | The lock-in defaults to the internal oscillator reference set at 100.000 kHz.

The default data screen is the Trend Graph. The 4 displayed parameters default to X, Y, R and θ . Each parameter has a numeric display, a bar graph and a trend graph. The trend graph is a continuously autoscaling graph of the recent history of each parameter. This data screen has no adjustments available. |
| 3. Touch {Ampl} in the info bar along the top of the screen. Then {1}{0}{0}{mV}. | The default sine amplitude is 0 Vrms. Thus the data displays will read 0 for X, Y and R. θ will be just noise.

The lock-in parameters shown in the info bar at the top of the screen may be entered using a numeric keypad simply by touching them. |



The Sine Out amplitude is specified for differential output (Sine+) – (Sine–). In this case, each BNC has an amplitude of 50 mV (rms) with a 50 Ω output. The lock-in input is high impedance so the output of each BNC is doubled and the lock-in measures 100 mV.

Since the phase shift of the sine output is very close to zero, X (green) should read about 0.1000 and Y (blue) should read close to 0.0000 V.

4. Connect the CH1 Output on the front panel to the DVM. Set the DVM to read dc Volts.

5. Press [Screen Layout] twice to show the half screen strip chart.

6. Touch the green scale tile {X} to display its scale palette.

Touch  to auto scale the green X trace.



Touch the green highlighted scale tile again to dismiss the scale palette.

7. Press [Sensitivity Down] to select 500 mV.

The CH1 output defaults to X. The output voltage (with ratio disabled) is given by:

$$\text{CH1} = \left(\frac{X}{\text{Sensitivity}} - \text{Offset} \right) \times \text{Expand} \times 10\text{V}$$

In this case, $X = 0.1 \text{ V}$, $\text{Sensitivity} = 1 \text{ V}$, the offset is zero percent and the expand is 1. The output should thus be 1 V or 10% of full scale.

Note that the bar graph for X (and R) is at +10%. The Sensitivity (1 V) sets the full scale for the bar graphs of X, Y and R.

Now let's look at how the Sensitivity affects the different displays.

 auto scales the trace keeping zero at the center. The zero location is indicated by the small green triangle on the right edge. The scale is 50 mV/div so the green data is a line 2 divisions above the center.

The DVM should now read 2 V. This is because X (100 mV) is now 20% of the sensitivity (500 mV). This also increases the bar graph to +20% and increases the resolution of the numeric readout.

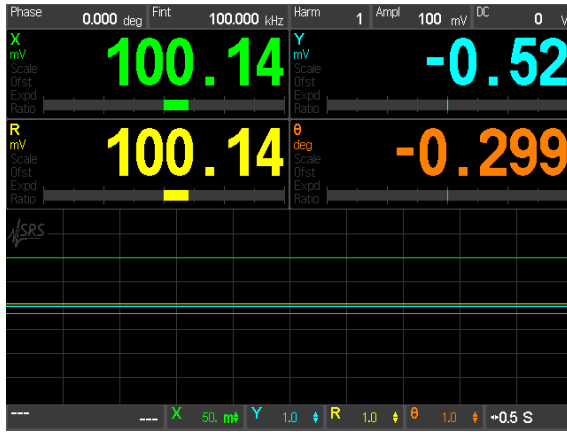

- Press [Sensitivity Down] two more times to select 100 mV.

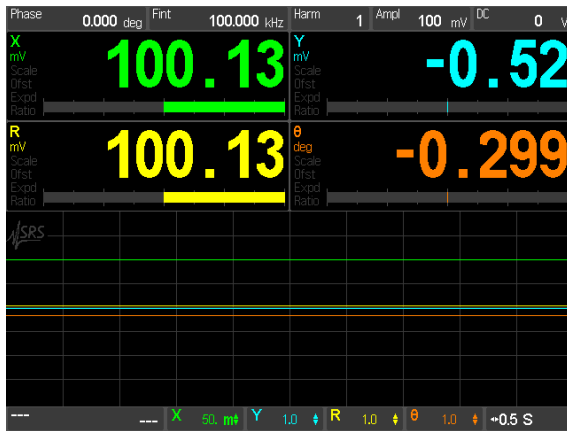

- Press and hold the <CH1 Offset> knob (above the CH1 BNC) to display the offset keypad.

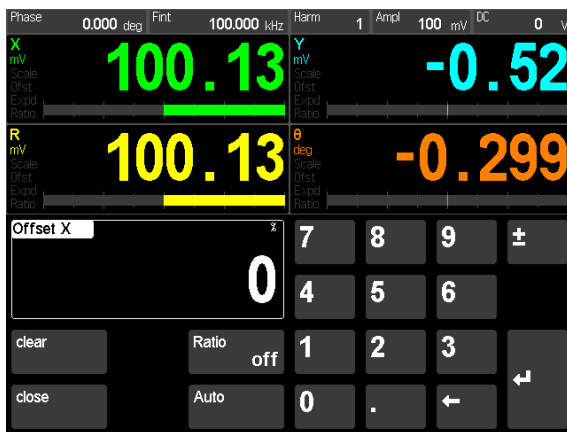

- Touch {Auto} in the offset keypad screen.

Note that the trace of X is unchanged. This is because the value of X is unchanged.

The Sensitivity does not affect the value of the output, just the way the value is scaled to the displays and analog output.

The Sensitivity applies to X, Y and R.

The DVM should now read 10 V and X is now 100% of full scale on the bar graph.

It is important to adjust the Sensitivity even if the analog outputs are not being used. The Sensitivity determines the resolution of the numeric readouts and bar graphs.

[Auto Scale] will adjust the Sensitivity automatically.

X, Y and R may all be offset, ratioed, and expanded separately.

Since CH1 is set to X (indicated by the **X** LED above the [Select] key) the <CH1 Offset> knob and [Expand] key above the CH1 BNC set the X offset and expand.

The [CH1 Select] key determines which quantity (X or R) is offset, ratioed, or expanded, and output on the BNC.

The ratio function is described later in this manual, in the Operation chapter. Here we will explore offset and expand.

Auto Offset automatically adjusts the X offset (or Y or R) such that X (or Y or R) becomes zero. In this case, X is offset to zero. The offset should be about 100%. Offsets are set as a

11. Touch {9} {0} {Enter} to set the offset to 90%.

12. Press the <CH1 Offset> knob briefly once to turn the X offset off.

Press it again to turn it back on.

13. Press [CH1 Expand] once to select $\times 10$.

percentage of the Sensitivity up to 999% ($10\times$). Offsets are useful for making relative measurements.

Offsets can also be set using the keypad or <Offset> knob.

The offset affects the value of X and any outputs or displays of X. The DVM voltage should be zero in this case.

The Offset indicator turns on next to the <CH1 Offset> knob. The X display on the screen has an 'Ofst' indication that the displayed quantity is affected by an offset. In this case, the bar graph and numeric value are both zero.

The X output (10 mV) is now 10% of the sensitivity (100 mV). The bar graph is at 10% and the DVM reads 1 V.

Notice that the trace of X (green) is a line 10 mV above zero (center). This is because the offset affects the value of X (unlike the sensitivity).

The offset for CH1 can be turned on and off without changing the offset value. Notice how the trace of X changes when the offset is turned off.

Leave the X offset on for now.

Expand $\times 10$ effectively decreases the sensitivity by 10 after the offset is applied.

$$\text{CH1} = \left(\frac{X}{\text{Sensitivity}} - \text{Offset} \right) \times \text{Expand} \times 10\text{V}$$

Now, X = 100 mV, Sensitivity = 100 mV, the offset is 90% and the expand is $\times 10$. Thus the DVM reads 10 V.

The X bar graph is now at 100% and the numeric readout has added resolution. The X display has an 'Expd' indication that the displayed quantity is affected by a non-unity expand.

Expand increases the resolution of the X display and CH1 output. Note that the trace of X is unaffected by expand. This is because expand does not change the value of X.

14. Press [CH1 Expand] once to select $\times 100$.

15. Press [CH1 Expand] once to turn off expand.
 Press the <CH1 Offset> knob briefly once to turn the X offset off.

16. Touch the green scale tile {X} to display its scale palette.

Touch  to auto scale the green X trace.



The red output **Overload** LED lights and a ‘Scale’ overload is indicated in the X display. This is because CH1 is trying to reach 100 V (10 times the previous DVM reading). Since the CH1 output is limited to 10 V, the output is overloaded. This has no affect on the value of X and the trace is unchanged. The bar graph and displayed value are pinned however.

The X display returns to 100 mV, 100% bar graph and 10 V CH1 output. The X graph is a line at 100 mV 2 divisions above center.

With offset and expand, the output voltage gain and offset can be programmed to provide control of feedback signals with the proper bias and gain for a variety of situations.

Offsets add and subtract from the values of X, Y and R.



Expand increases the resolution of the displays and analog outputs but does not change the values of X, Y and R.

When using the strip chart graph exclusively, there is no need to use offset or expand to zoom in on the data. Simply auto scale the data channel to graphically offset and expand the chart data.

See the Outputs and Scales discussion in the next chapter for more detailed information on output scaling

Saving and Recalling Setups

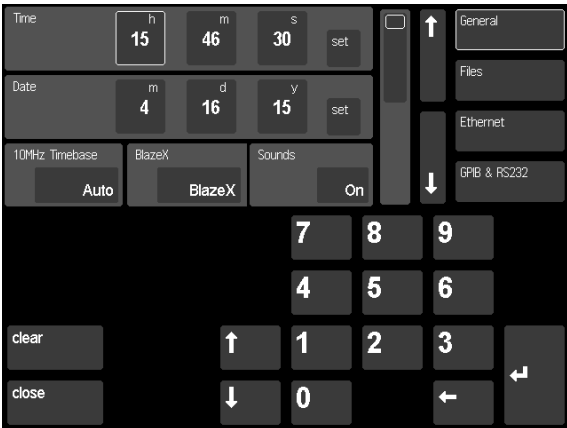
The SR860 can store 8 complete instrument setups in non-volatile memory.

Do This	Explanation
<ol style="list-style-type: none"> 1. Disconnect all cables from the lock-in. Turn the power on while holding down the [Local] key. The power switch is on the power entry module on the rear panel. 2. Press and hold [Calc/system] to display the system menu. 	<p>When the power is turned on with [Local] pressed, the lock-in returns to its standard default settings. See the Standard Settings list in the Operation section for a complete listing of the settings.</p> <p>First let's set the SR860 clock.</p> <p>The system menu is where instrument parameters (not measurement parameters) are set. This includes file numbering, interface settings and software updates.</p>
	
<ol style="list-style-type: none"> 3. Touch the {h} button in the Time section to highlight the hours setting. Use the keypad to set the hour of day in 24 hour format. The time/date will highlight in orange indicating that the displayed time is not the current time but rather the time to be set. 	<p>The time and date are used to label data files, screen shots, and saved settings.</p>
 <p>Continue to enter the minutes, seconds then touch {Time set} to commit the time to the internal clock.</p> <p>Set the date in the same manner touching {Date set} to commit the date.</p>	
<ol style="list-style-type: none"> 4. Press [Sensitivity Down] 3 times to select 100 mV. Press [Time Constant Up] twice to select 1 s. 	<p>Let's change the lock-in setup so that we have a non-default setup to save.</p> <p>Change the Sensitivity, Time Constant and Filter Slope.</p>

Press [Filter Slope] once to select 12 dB/oct.

- Press [Save Recall] to display the Save/Recall screen.



- Touch the {Save} button next to the large tile labelled '1'.



Enter a name for this setup using the keypad.

Touch {Confirm} to commit the current setup to location 1.

- Now change the Sensitivity, Time Constant and Filter Slope to new settings.
- Press [Save Recall] to display the Save/Recall screen again.

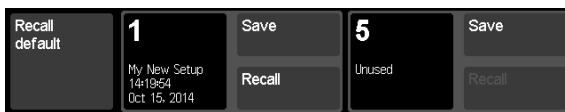

The SR860 can store 8 complete setups. In addition the default setup can be recalled.

Setups are numbered 1 through 8. Setups should be named so they are easily distinguished.

Change the lock-in setup before recalling the saved settings.

Note that the Location 1 tile displays the setup name and the time and date it was created. This makes it easier to recall the correct setup.

9. Touch {Recall} for Location 1.

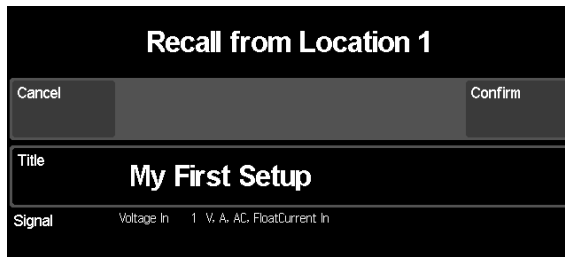

Touch {Confirm} to recall the setup and dismiss this screen.

A summary of settings which will change upon recall is shown.

Simply touch {Cancel} to skip recalling this setup.

The Sensitivity, Time Constant and Filter Slope should all return to the saved settings.

Aux Outputs and Inputs

This measurement is designed to illustrate the use of the Aux Outputs and Inputs on the rear panel. You will need BNC cables and a digital voltmeter (DVM).

Specifically, you will set the Aux Output voltages and measure them with the DVM. These outputs will then be connected to the Aux Inputs to simulate external dc voltages which the lock-in can measure.

Do This	Explanation
1. Disconnect all cables from the lock-in. Turn the power on while holding down the [Local] key. The power switch is on the power entry module on the rear panel.	When the power is turned on with [Local] pressed, the lock-in returns to its standard default settings. See the Standard Settings list in the Operation section for a complete listing of the settings.
2. Connect Aux Out 1 on the rear panel to the DVM. Set the DVM to read dc volts.	The 4 Aux Outputs can provide programmable voltages between -10.5 and $+10.5$ volts. The outputs can be set from the front panel or via the computer interface.
3. Press [Aux Output] to show the Aux Output keypad.	Aux Outputs are easily set from the front panel.
	
4. Touch {1}{0}{Enter} to set Aux 1 to 10.000 V. Use the <Cursor> knob adjust the level to 5.000 V.	The DVM should display 10.00 V. The <Cursor> knob is used to adjust values when the Aux Output keypad is shown. The DVM should display 5.00 V. The 4 Aux Outputs are useful for controlling other parameters in an experiment, such as pressure, temperature, wavelength, etc.

5. Touch [Screen Layout] multiple times to show the full numeric display screen.



Note the 4 Aux Output values are displayed in white tiles across the bottom. Touching an output tile will display the Aux Output keypad.

6. Disconnect the DVM from Aux Out 1. Connect Aux Out 1 to Aux In 1 on the rear panel.

This screen displays the 4 Aux Input readings along with the 4 lock-in data channels. The Aux Inputs are always scaled to 10 V.

The Aux Inputs can read 4 analog voltages. These inputs are useful for monitoring and measuring other parameters in an experiment, such as pressure, temperature, position, etc.

We'll use Aux Out 1 to provide an analog voltage to measure.

Aux In 1 should now read 5.000 V.

The Aux Inputs can be assigned to a data channel and graphed on the strip chart alongside lock-in outputs. Use the [Config] key to change a data channel.

Scanning

This measurement is designed to use the internal oscillator and an external signal source to explore some of the display types. You will need a synthesized function generator capable of providing a 500 mVrms sine wave at 100.000 kHz, BNC cables and a terminator appropriate for the generator function output.

Specifically, you will scan the lock-in internal reference frequency through the signal frequency.

Do This	Explanation
<p>1. Disconnect all cables from the lock-in. Turn the power on while holding down the [Local] key. The power switch is on the power entry module on the rear panel.</p>	<p>When the power is turned on with [Local] pressed, the lock-in returns to its standard default settings. See the Standard Settings list in the Operation section for a complete listing of the settings.</p>
<p>2. Turn on the function generator, set the frequency to 100.000 kHz (exactly) and the amplitude to 500 mVrms.</p> <p>Connect the function output (sine wave) from the synthesized function generator to the A input using a BNC cable and appropriate terminator.</p>	<p>The input impedance of the lock-in is 10 MΩ. The generator may require a terminator. Many generators have either a 50Ω or 600Ω output impedance. Use the appropriate feedthrough or T termination if necessary. In general, not using a terminator means that the function output amplitude will not agree with the generator setting.</p> <p>The internal oscillator should be very close to the actual generator frequency. The X (green) and Y (blue) displays should read values which change slowly. The lock-in and the generator are not phase locked but they are at the same frequency with some slowly changing θ (orange). The signal magnitude R (yellow) is phase independent and does not change.</p>
<p>3. Press and hold [Scan/setup] to display the scan menu.</p>	<p>Parameters which may be scanned are F_{internal}, Amplitude, DC Level, Aux Out 1 and 2.</p> <p>Scans can be linear or logarithmic, repeat, repeat up and down or run once and pause.</p> <p>The Scan Duration is the total time to move from the Begin Value to the End Value. The Parameter Update Interval is the time spent at each scan step along the way. The shorter the update time, the smaller the steps and the smoother the scan. The longer the update time, the fewer steps. With experiments that take time to settle after a parameter change, it can be beneficial to set the update time long enough to accommodate the settling.</p>

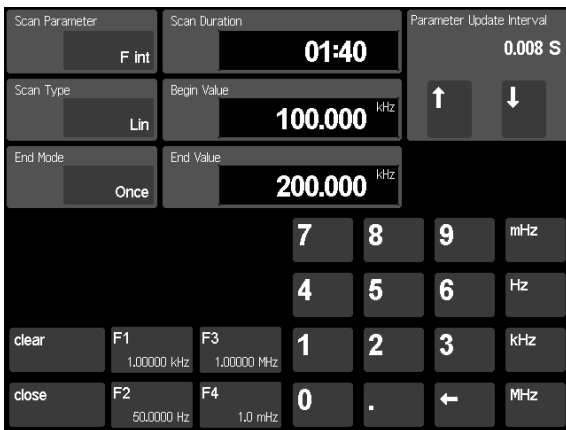

4. Let's leave the Scan Parameter at internal reference frequency.

Touch {Begin Value} to highlight the start frequency. Enter 99.990 kHz.

Touch {End Value} to highlight the stop frequency. Enter 100.010 kHz.

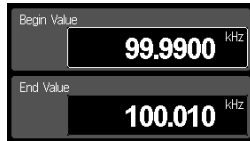

5. Touch {End Mode} once to select Repeat.
6. Touch {Close} to return to the Trend Graphs.
7. Press [Scan/setup] briefly (don't hold it) to turn on the scan.
8. Press [Play Pause/reset] briefly (don't hold it) to start the scan.



9. Press [Screen Layout] once to show the full screen strip chart.
- Touch the white scale tile {Time} to display the horizontal scale palette (bottom right of screen).
- Touch  repeatedly to zoom out to 10 S/div.

Let's scan a 20 Hz span around the signal frequency (100.000 kHz).

This setup will increase the internal frequency from 99.990 kHz to 100.010 kHz. To reverse the scan, simply reverse the begin and end values.

This will repeat the scan over and over jumping from the end value back to the begin value at the end of each scan.

The lock-in frequency has not been changed, we have only configured a scan. The scan has not been started.

The **Ready** LED turns on indicating that the scan is ready (at the start value). In this case, the internal frequency (in the info bar at the top) is shown in orange indicating that it is under scan control. At this time, the frequency is the start value or 99.9900 kHz.

The **Run** LED turns on indicating that the scan is running.





The internal frequency starts scanning up. The current value is shown in orange in the info bar. When the end value is reached, the scan resets to the beginning value and repeats.

The trend graphs show a resonance as the internal frequency passes through 100.000 kHz. This is because the difference between the f_{signal} and f_{internal} gets slower as the f_{internal} approaches f_{signal} and then gets faster after it passes f_{signal} . The time constant attenuates this difference frequency when it is large.

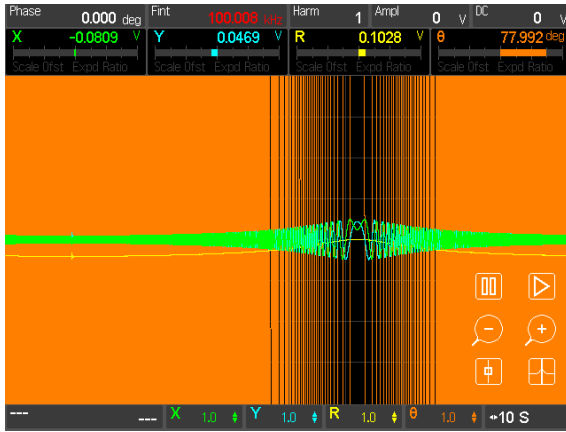
It is much easier to visualize a scan using the strip charts since the chart time scale can be matched to the scan time.

This scan takes 1m40s or 100 s so a chart span of 100 s will display an entire scan.



10. Touch the green scale tile {X} to display its scale palette. Touch  to dismiss the X trace. Touch the blue scale tile {Y} to display its scale palette. Touch  to dismiss the Y trace.
11. Touch the yellow scale tile {R} to display its scale palette. Touch  to auto scale the R trace. Touch the orange scale tile {theta} to display its scale palette. Touch  to repeatedly to change the scale to 200 deg/div.
12. Press [Config] to change the assignments of the data channels.

Touch {Data 2 Display} (the blue display) to highlight the channel 2 data source. Touch {Fint} from the keypad below.

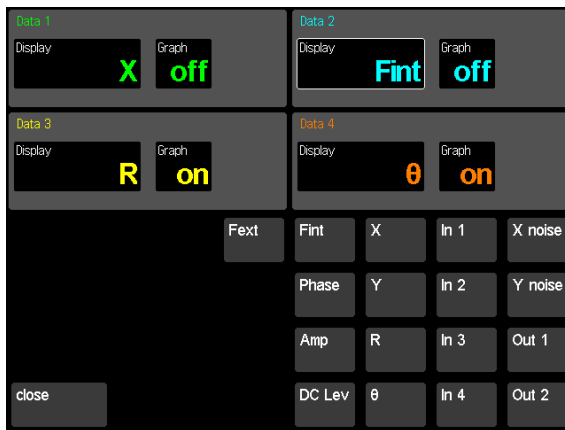

Touch {Close} to return to the strip chart.

Let's clean up the chart by dismissing the X and Y traces.

The magnitude trace (R) shows the lock-in response as the internal frequency scans through the signal frequency at this time constant and filter.

Reduce the phase trace to see the resonance at 100.000 kHz.

It would be nice to show the frequency on the graph.

The 4 data channels can be assigned to different parameters in the Config screen.

Any data channel can be assigned any of the sources in the keypad.

When the Config screen is closed the strip chart does not display a blue trace. This is because we dismissed it previously.

13. Touch the blue scale tile {Fi} to display its scale palette.

Touch  to auto scale the blue F trace.

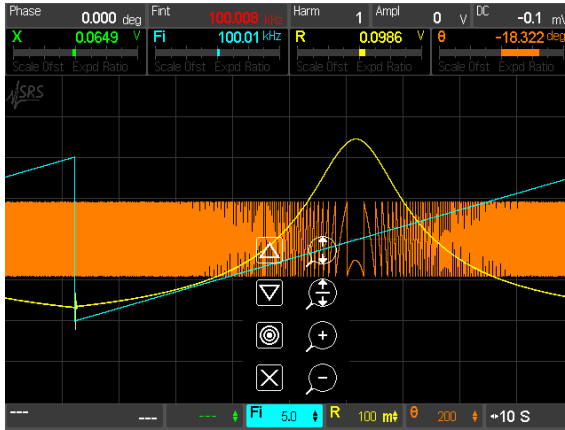

14. Touch the white scale tile {Time} to display the horizontal scale palette (bottom right of screen).

Touch  repeatedly to zoom out a few times.

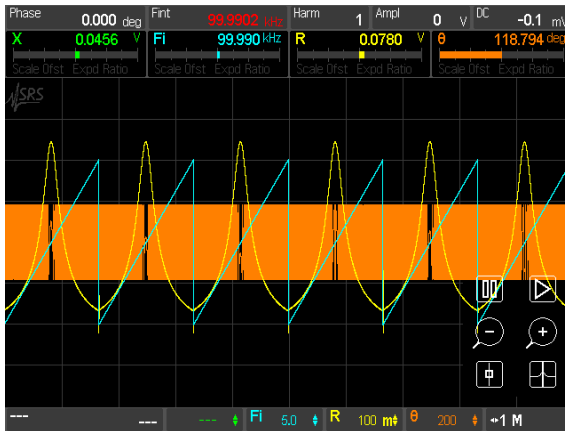

15. Press and hold [Scan/setup] to display the scan menu again.

Touch {End Mode} multiple times to select Once.

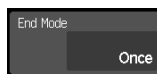

Touch {Close} to return to the strip chart.

16. Press [Scan/setup] briefly (don't hold it) to turn the scan off, then press [Scan/setup] briefly again to re-arm.

Simply touching the blue scale tile turns the blue trace back on and displays its scale palette.

The blue frequency trace shows the upward scan of the frequency spanning 4 divisions or 20 Hz.

Since the scan End Mode is set to repeat, we see the scan repeat over and over in the history.

When scanning, it is convenient to pause the strip chart at the end of the scan to review the results.

When the End Mode is Once, then the scan stops at the end value and the strip chart is paused.

Changes to the scan setup do not affect a currently-running scan. We stop the scan and then start a new one by cycling the [Scan/setup] button; the **Ready** LED goes off and then on.

17. Press [Play Pause/reset] briefly (don't hold it) to re-start the scan.



18. Touch the white scale tile {Time} to display the horizontal scale palette (bottom right of screen).

Touch repeatedly to zoom in to 10 S/div.

Touch the highlighted white scale tile again to dismiss the scale palette.

Wait for the scan to finish.

19. Use the <Cursor> knob to move the cursor to the peak of R (yellow).

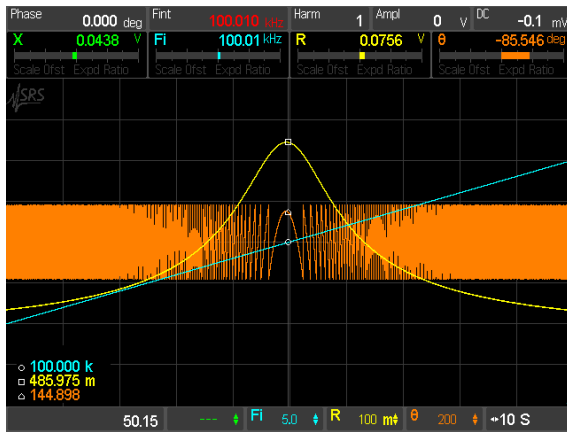

20. Touch the white scale tile {Time} to display the horizontal scale palette (bottom right of screen).

Touch start the strip chart again.

Touch the highlighted white scale tile again to dismiss the scale palette.

21. Press and hold [Play Pause/reset] to reset the scan back to the begin value.
22. Press [Play Pause/reset] briefly to start the scan again.

The **Run** LED turns on indicating that the scan is running.

This scan is 100 s in length so set the graph to 10 divisions of 10 s to show a complete scan.

When the scan finishes, the **Done** LED turns on.

When the scan in progress reaches the end value the strip chart pauses.

The frequency will hold at the end value (100.010 kHz) as displayed in the info bar.

The cursor is active when the strip chart is paused.

Notice that data collection continued while the chart was paused. Restarting the chart realigns the time history so the current time is the right edge again.

In this case, the frequency has been constant at 100.010 kHz the entire time we have been examining the paused scan.

This resets the scan parameter back to the begin value. The **Done** LED turns off.

This starts the scan again. The **Run** LED turns on and the frequency ramps upward.



While the scan is in progress, press [Scan/setup] briefly to turn scanning off.

Turn the scan off before the end and the internal frequency returns to its original value (100.000 kHz) as shown in white in the info bar.

Chapter 2

Lock-in Amplifier Basics

What is a Lock-in Amplifier?

Lock-in amplifiers are used to detect and measure very small ac signals — all the way down to a few nanovolts. Accurate measurements may be made even when the small signal is obscured by noise sources many thousands of times larger.

Lock-in amplifiers use a technique known as phase-sensitive detection to single out the component of the signal at a specific reference frequency and phase. Noise signals at frequencies other than the reference frequency are rejected and do not affect the measurement.

Why use a lock-in?

Let's consider an example. Suppose the signal is a 10 nV sine wave at 10 kHz. Clearly some amplification is required. A good low noise amplifier may have about 5 nV/ $\sqrt{\text{Hz}}$ of input noise. If the amplifier bandwidth is 100 kHz and the gain is 1000, then we can expect our output to be 10 μV of signal ($10 \text{ nV} \times 1000$) and 1.6 mV of broadband noise ($5 \text{ nV}/\sqrt{\text{Hz}} \times \sqrt{100 \text{ kHz}} \times 1000$). We won't have much luck measuring the output signal unless we single out the frequency of interest.

If we follow the amplifier with a band pass filter with a $Q=100$ (a very good filter) centered at 10 kHz, any signal in a 100 Hz bandwidth will be detected ($10 \text{ kHz}/Q$). The noise in the filter pass band will be 50 μV ($5 \text{ nV}/\sqrt{\text{Hz}} \times \sqrt{100 \text{ Hz}} \times 1000$) and the signal will still be 10 μV . The output noise is still much greater than the signal and an accurate measurement cannot be made. Further gain will not help the signal to noise problem.

Now try following the amplifier with a phase-sensitive detector (PSD). The PSD can detect the signal at 10 kHz with a bandwidth as narrow as 0.01 Hz! In this case, the noise in the detection bandwidth will be only 0.5 μV ($5 \text{ nV}/\sqrt{\text{Hz}} \times \sqrt{0.01 \text{ Hz}} \times 1000$) while the signal is still 10 μV . The signal to noise ratio is now 20 and an accurate measurement of the signal is possible.

What is phase-sensitive detection?

Lock-in measurements require a frequency reference. Typically an experiment is excited at a fixed frequency (from an oscillator or function generator) and the lock-in detects the response from the experiment at the reference frequency. In the diagram below, the reference signal is a square wave at frequency f_{ref} . This might be the sync output from a function generator. If the sine output from the function generator is used to excite the experiment, the response might be the signal waveform shown below. The signal is $V_{\text{sig}}\sin(\omega_{\text{ref}}t + \theta_{\text{sig}})$ where $\omega_{\text{ref}} = 2\pi f_{\text{ref}}$ and V_{sig} is the signal amplitude.

The SR860 generates its own sine wave at frequency f_L , shown as the lock-in reference below. The lock-in reference is $\sin(\omega_L t + \theta_{ref})$ where $\omega_L = 2\pi f_L$.

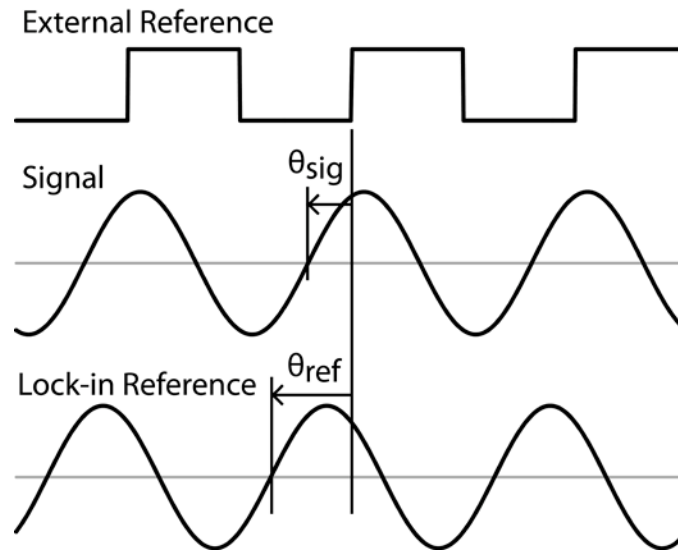

The SR860 amplifies the signal and then multiplies it by the lock-in reference using a phase-sensitive detector (PSD) or multiplier. The output of the PSD is simply the product of two sine waves.

$$\begin{aligned} V_{psd} &= V_{sig} \sin(\omega_r t + \theta_{sig}) \sin(\omega_L t + \theta_{ref}) \\ &= 1/2 V_{sig} \cos([\omega_r - \omega_L]t + \theta_{sig} - \theta_{ref}) - \\ &\quad 1/2 V_{sig} \cos([\omega_r + \omega_L]t + \theta_{sig} + \theta_{ref}) \end{aligned}$$

The PSD output is two ac signals, one at the difference frequency ($\omega_r - \omega_L$) and the other at the sum frequency ($\omega_r + \omega_L$).

If the PSD output is passed through a low pass filter, the ac signals are removed. What will be left? In the general case, nothing. However, if ω_r equals ω_L , the difference frequency component will be a dc signal. In this case, the filtered PSD output will be

$$V_{psd} = 1/2 V_{sig} \cos(\theta_{sig} - \theta_{ref})$$

This is a very nice signal — it is a dc signal proportional to the signal amplitude.

Narrow band detection

Now suppose the input is made up of signal plus noise. The PSD and low pass filter only detect signals whose frequencies are very close to the lock-in reference frequency. Noise signals at frequencies far from the reference are attenuated at the PSD output by the low pass filter (neither $\omega_{noise} - \omega_{ref}$ nor $\omega_{noise} + \omega_{ref}$ are close to dc). Noise at frequencies very close to the reference frequency will result in very low frequency ac outputs from the PSD ($|\omega_{noise} - \omega_{ref}|$ is small). Their attenuation depends upon the low pass filter bandwidth and roll-off. A narrower bandwidth will remove noise sources very close to the reference frequency, a wider bandwidth allows these signals to pass. The low pass filter bandwidth determines the bandwidth of detection. Only the signal at the reference frequency will

result in a true dc output and be unaffected by the low pass filter. This is the signal we want to measure.

Where does the lock-in reference come from?

We need to make the lock-in reference the same as the signal frequency, i.e. $\omega_r = \omega_L$. Not only do the frequencies have to be the same, the phase between the signals cannot change with time, otherwise $\cos(\theta_{\text{sig}} - \theta_{\text{ref}})$ will change and V_{psd} will not be a dc signal. In other words, the lock-in reference needs to be phase-locked to the signal reference.

Lock-in amplifiers use a phase-locked loop (PLL) to generate the reference signal. An external reference signal (in this case, the reference square wave) is provided to the lock-in. The PLL in the lock-in “locks” the internal reference oscillator to this external reference, resulting in a reference sine wave at ω_r with a fixed phase shift of θ_{ref} . Since the PLL actively tracks the external reference, changes in the external reference frequency do not affect the measurement.

All lock-in measurements require a reference signal

In this case, the reference is provided by the excitation source (the function generator). This is called an external reference source. In many situations, the lock-in’s internal oscillator may be used instead. The internal oscillator is just like a function generator (with variable sine output and a TTL sync) which is always phase-locked to the reference oscillator.

Magnitude and phase

Remember that the PSD output is proportional to $V_{\text{sig}}\cos\theta$ where $\theta = (\theta_{\text{sig}} - \theta_{\text{ref}})$. θ is the phase difference between the signal and the lock-in reference oscillator. By adjusting θ_{ref} we can make θ equal to zero, in which case we can measure V_{sig} ($\cos\theta = 1$). Conversely, if θ is 90° , there will be no output at all. A lock-in with a single PSD is called a single-phase lock-in and its output is $V_{\text{sig}}\cos\theta$.

This phase dependency can be eliminated by adding a second PSD. If the second PSD multiplies the signal with the reference oscillator shifted by 90° , i.e. $\sin(\omega_L t + \theta_{\text{ref}} + 90^\circ)$, its low pass filtered output will be

$$V_{\text{psd2}} = 1/2 V_{\text{sig}} \sin(\theta_{\text{sig}} - \theta_{\text{ref}})$$

$$V_{\text{psd2}} \sim V_{\text{sig}} \sin\theta$$

Now we have two outputs, one proportional to $\cos\theta$ and the other proportional to $\sin\theta$. If we call the first output X and the second Y,

$$X = V_{\text{sig}} \cos\theta \quad Y = V_{\text{sig}} \sin\theta$$

these two quantities represent the signal as a vector relative to the lock-in reference oscillator. X is called the 'in-phase' component and Y the 'quadrature' component. This is because when $\theta = 0$, X measures the signal while Y is zero.

By computing the magnitude (R) of the signal vector, the phase dependency is removed.

$$R = (X^2 + Y^2)^{1/2} = V_{\text{sig}}$$

R measures the signal amplitude and does not depend upon the phase between the signal and lock-in reference.

A dual-phase lock-in, such as the SR860, has two PSD's, with reference oscillators 90° apart, and can measure X, Y and R directly. In addition, the phase θ between the signal and lock-in reference, can be measured according to

$$\theta = \tan^{-1} (Y/X)$$

What Does a Lock-in Measure?

So what exactly does the SR860 measure? Fourier's theorem basically states that any input signal can be represented as the sum of many sine waves of differing amplitudes, frequencies and phases. This is generally considered as representing the signal in the “frequency domain”. Normal oscilloscopes display the signal in the “time domain”. Except in the case of clean sine waves, the time domain representation does not convey very much information about the various frequencies that make up the signal.

What does the SR860 measure?

The SR860 multiplies the input signal by a pure sine wave at the reference frequency. All components of the input signal are multiplied by the reference simultaneously. Mathematically speaking, sine waves of differing frequencies are orthogonal, i.e. the average of the product of two sine waves is zero unless the frequencies are *exactly* the same. In the SR860, the product of this multiplication yields a dc output signal proportional to the component of the signal whose frequency is exactly locked to the reference frequency. The low pass filter which follows the multiplier provides the averaging which removes the products of the reference with components at all other frequencies.

The SR860, because it multiplies the signal with a pure sine wave, measures the single Fourier (sine) component of the signal at the reference frequency. Let's take a look at an example. Suppose the input signal is a simple square wave at frequency f . The square wave is actually composed of many sine waves at multiples of f with carefully related amplitudes and phases. A 2V pk-pk square wave can be expressed as

$$S(t) = 1.273 \sin(\omega t) + 0.4244 \sin(3\omega t) + 0.2546 \sin(5\omega t) + \dots$$

where $\omega = 2\pi f$. The SR860, locked to f will single out the first component. The measured signal will be $1.273 \sin(\omega t)$, not the 2V pk-pk that you'd measure on a scope.

In the general case, the input consists of signal plus noise. Noise is represented as varying signals at all frequencies. The ideal lock-in only responds to noise at the reference frequency. Noise at other frequencies is removed by the low pass filter following the multiplier. This “bandwidth narrowing” is the primary advantage that a lock-in amplifier provides. Only inputs at the reference frequency result in an output.

RMS or Peak?

Lock-in amplifiers as a general rule display the input signal in Volts RMS. When the SR860 displays a magnitude of 1V (rms), the component of the input signal at the reference frequency is a sine wave with an amplitude of 1 V_{rms} or 2.8 V pk-pk.

Thus, in the previous example with a 2 V pk-pk square wave input, the SR860 would detect the first sine component, $1.273 \sin(\omega t)$. The measured and displayed magnitude would be 0.90 V (rms), e.g. $1.273/\sqrt{2}$.

Degrees or Radians?

In this discussion, frequencies have been referred to as f (Hz) and ω ($2\pi f$ radians/sec). This is because people measure frequencies in cycles per second and math works best in radians. For purposes of measurement, frequencies as measured in a lock-in amplifier are in Hz. The equations used to explain the actual calculations are sometimes written using ω to simplify the expressions.

Phase is always reported in degrees. Once again, this is by custom. Equations written as $\sin(\omega t + \theta)$ are written as if θ is in radians mostly for simplicity. Lock-in amplifiers always manipulate and measure phase in degrees.

Block diagram

A simplified block diagram of the SR860's lock-in circuit is shown below and explained in the following sections.

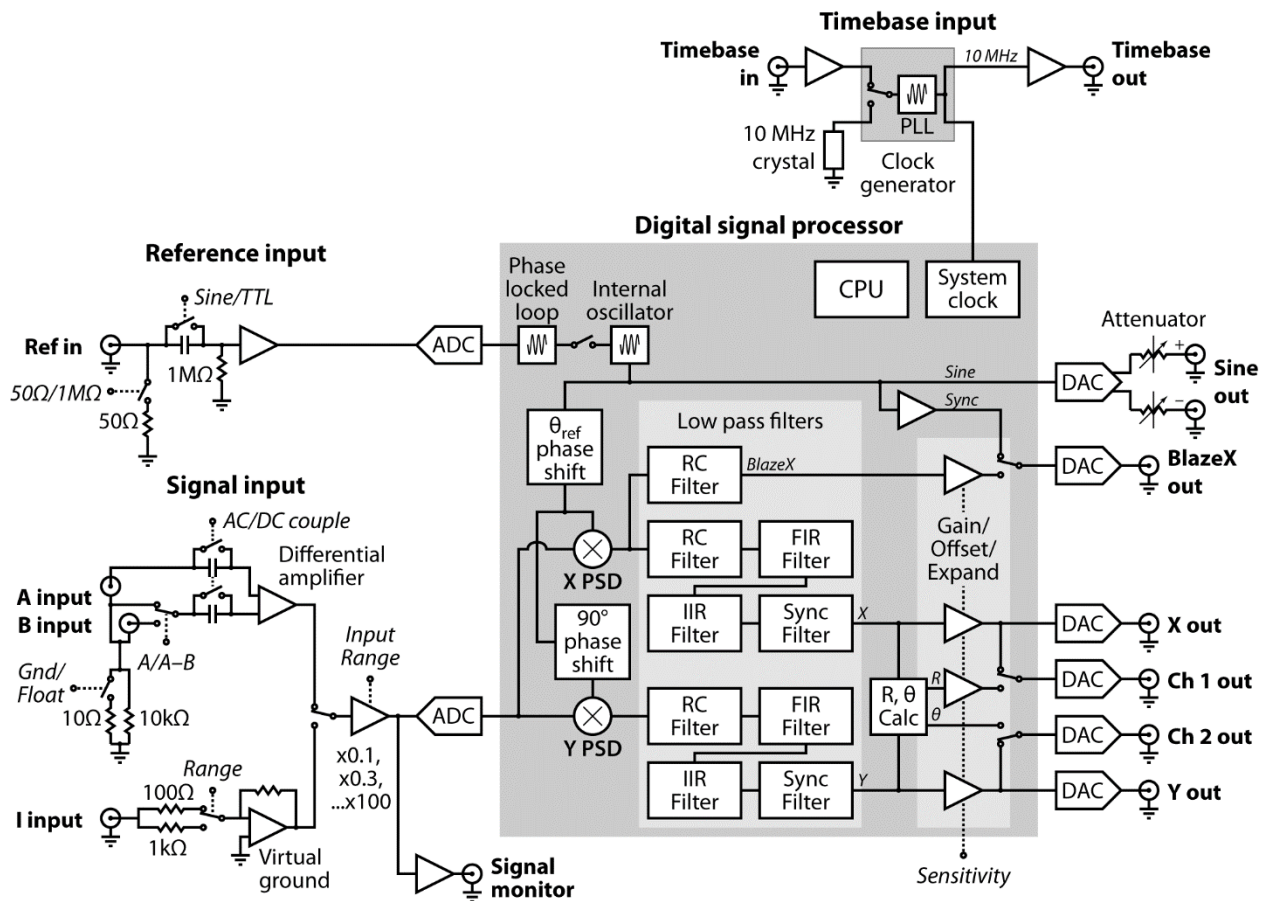

The Reference Oscillator

A lock-in amplifier requires a reference oscillator phase-locked to the signal frequency. In general, this is accomplished by phase-locking an internal oscillator to an externally provided reference signal. This reference signal usually comes from the signal source that is providing the excitation to the experiment.

Reference Input

The SR860 reference input can trigger on an analog signal (like a sine wave) or a TTL logic signal. The first case is called External Sine. The input is ac coupled (above 1 Hz) and the input impedance is 1 M Ω . A sine wave input greater than 200 mV pk is required. Positive zero crossings are detected and considered to be the zero for the reference phase shift.

TTL reference signals can be used at all frequencies up to 500 kHz. **For frequencies below 1 Hz, a TTL reference signal is required.** Many function generators provide a TTL SYNC output which can be used as the reference. This is convenient since the generator's sine output might be smaller than 200 mV or be varied in amplitude. The SYNC signal will provide a stable reference regardless of the sine amplitude.

When using a TTL reference, the reference input trigger can be set to Pos TTL (detect rising edges) or Neg TTL (detect falling edges). In each case, the internal oscillator is locked (at zero phase) to the detected edge.

Internal Oscillator

The internal oscillator in the SR860 is basically a 500 kHz function generator with sine and sync outputs. The oscillator generates a digitally synthesized sine wave. The internal oscillator sine wave is output differentially at the SINE OUT BNC's on the front panel. An attenuator sets the amplitude of the output to a value between 1 nV and 2 V (rms).

When an external reference is used, this internal oscillator sine wave is phase-locked to the reference. The rising zero crossing is locked to the detected reference zero crossing or edge. In this mode, the SINE OUT provides a sine wave phase-locked to the external reference. Phase locking is accomplished digitally by the SR860.

The internal oscillator may be used without an external reference. In the Internal Reference mode the frequency is set in the lock-in and the SINE OUT provides the excitation for the experiment. The phase-locked-loop is not used in this mode.

The BlazeX output on the rear panel can be configured to provide the sync output. The internal oscillator's rising zero crossings are detected and the output is a square wave.

Reference Oscillators and Phase

The internal oscillator sine wave is not the reference signal to the phase sensitive detectors. The SR860 computes a second sine wave, phase shifted by θ_{ref} from the internal oscillator (and thus from an external reference), as the reference input to the X phase sensitive detector. This waveform is $\sin(\omega t + \theta_{\text{ref}})$. The reference phase shift is adjustable in 0.001° increments.

The input to the Y PSD is a third sine wave, computed by the SR860, shifted by 90° from the second sine wave. This waveform is $\sin(\omega_r t + \theta_{\text{ref}} + 90^\circ)$.

The phase shifts (θ_{ref} and the 90° shift) are exact numbers and accurate to better than 0.000001° . Neither waveform is actually output in analog form since the phase sensitive detectors are actually digital multipliers inside the SR860.

Phase Jitter

When an external reference is used, the phase-locked loop contributes a little phase jitter. The internal oscillator is supposed to be locked with zero phase shift relative to the external reference. Phase jitter means that the average phase shift is zero but the instantaneous phase shift has a few microdegrees or millidegrees of noise. This shows up at the output as noise in phase or quadrature measurements.

Phase noise can also cause noise to appear at the X and Y outputs. This is because a reference oscillator with a lot of phase noise is the same as a reference whose frequency spectrum is spread out. That is, the reference is not a single frequency, but a distribution of frequencies about the true reference frequency. These spurious frequencies are attenuated quite a bit but can still cause problems. The spurious reference frequencies result in signals close to the reference being detected. Noise at nearby frequencies now appears near dc and affects the lock-in output.

Phase noise in the SR860 is very low and generally causes no problems. In applications requiring no phase jitter, the internal reference mode should be used. Since there is no PLL, the internal oscillator and the reference sine waves are directly linked and there is no jitter in the measured phase. (Actually, the phase jitter is the phase noise of a crystal oscillator and is very, very small).

Harmonic Detection

It is possible to compute the two PSD reference sine waves at a multiple of the internal oscillator frequency. In this case, the lock-in detects signals at $N \times f_{\text{ref}}$ which are synchronous with the reference. The SINE OUT frequency is not affected. The SR860 can detect at any harmonic up to $N=99$ as long as $N \times f_{\text{ref}}$ does not exceed 500 kHz.

The Phase Sensitive Detectors

The amplified input signal is converted to digital form using A/D converter sampling at 10 MHz. The SR860 then multiplies the signal with the reference sine wave digitally.

The dynamic reserve is limited by the quality of the A/D conversion. Once the input signal is digitized, no further errors are introduced. Certainly the accuracy of the multiplication does not depend on the size of the numbers. The A/D converter used in the SR860 is extremely linear, meaning that the presence of large noise signals does not impair its ability to correctly digitize a small signal. In fact, the dynamic reserve of the SR860 can exceed 120 dB without any problems. We'll talk more about dynamic reserve a little later.

We've discussed how the digital signal processor in the SR860 computes the internal oscillator and two reference sine waves and handles both phase sensitive detectors. In the

next section, we'll see how the SR860 performs the low pass filtering and dc amplification required at the output of the PSD's.

Time Constants and Sensitivity

Remember, the output of the PSD contains many signals. Most of the output signals have frequencies which are either the sum or difference between an input signal frequency and the reference frequency. Only the component of the input signal whose frequency is exactly equal to the reference frequency will result in a dc output.

The low pass filter at the PSD output removes all of the unwanted ac signals, both the $2f$ (sum of the signal and the reference) and the noise components. This filter is what makes the lock-in such a narrow band detector.

RC filters

Traditionally, the time constant setting of a lock-in amplifier determines the bandwidth of an RC lowpass filter. The time constant is simply $1/2\pi f$ where f is the -3 dB frequency of the filter. The low pass filters are simple 6 dB/octave roll off, RC type filters. A 1 second time constant referred to a filter whose -3 dB point occurred at 0.16 Hz and rolled off at 6 dB/octave beyond 0.16 Hz. Typically, there are two successive filters so that the overall filter can roll off at either 6 dB or 12 dB per octave. The time constant referred to the -3 dB point of each filter alone, not the combined filter.

The notion of time constant arises from the fact that the actual output is supposed to be a dc signal. In fact, when there is noise at the input, there is noise on the output. By increasing the time constant, the output becomes more steady and easier to measure reliably. The tradeoff comes when real changes in the input signal take many time constants to be reflected at the output. This is because a single RC filter requires about 5 time constants to settle to its final value. The time constant reflects how slowly the output responds, and thus the degree of output smoothing.

The time constant also determines the equivalent noise bandwidth (ENBW) for noise measurements. The ENBW is *not* the filter -3 dB pole, it is the effective bandwidth for Gaussian noise. More about this later.

The digital signal processing in the SR860 handles all of the low pass filtering. Each PSD can be followed by up to four filter stages for up to 24 dB/oct of roll off.

Why are multiple filter stages desirable? Consider an example where the reference is at 1 kHz and a large noise signal is at 1.05 kHz. The PSD noise outputs are at 50 Hz (difference) and 2.05 kHz (sum). Clearly the 50 Hz component is the more difficult to low pass filter. If the noise signal is 80 dB above the full scale signal and we would like to measure the signal to 1% (-40 dB), then the 50 Hz component needs to be reduced by 120 dB. To do this in two stages would require a time constant of at least 3 seconds. To accomplish the same attenuation in four stages only requires 100 ms of time constant. In the second case, the output will respond 30 times faster and the experiment will take less time.

Advanced Filters

The SR860 also provides advanced filtering in place of the traditional 6dB/octave RC filters. These filters can provide digital filtering that has no analog filter counterpart, and can settle up to twice as quickly as corresponding RC filters. If the input signal is changing rapidly, or if there is significant noise away from the reference frequency, then the advanced filters often provide better signal to noise with faster output response. See Appendix A for more information.

Floating Point Math in the SR860

The output points of the digital PSD in the SR860 are converted into floating point numbers. These numbers reflect the actual analog signal gain preceding the analog to digital converter and are simply the signal input voltages at the input BNC's. All digital filtering except for the Sync filter (described below) is performed using floating point math.

The SR860 plots these floating point outputs in the strip chart displays in units of Volts (or Amps) referred to the signal inputs. These values have no real limit in size (either too small or too large) and do not overload.

Sensitivity

So how does the SR860 provide an analog output proportional to the signal when the result is a floating point value that can range between 10^{-20} to 10^{20} , while the analog output can only range between +10V and -10V?

The answer is that the user must set a Sensitivity which sets the output voltage corresponding to full scale (10 V) at the output BNC. The Sensitivity also sets the scale for the displayed bar graphs and numerical readouts of X, Y and R. Note that this is a numerical output conversion. Output overloads do not affect the actual measurement results. They only indicate that the output value exceeds 100% of the chosen Sensitivity and the output BNC, the bar graph and the displayed numerical readout will be pinned at their maximums. The results displayed on the strip charts or available over the computer interfaces are the floating point outputs and are unaffected by output overloads.

The Sensitivity is chosen to conveniently and accurately display the measurement results on the output BNC, the bar graph and the numerical readout. The Sensitivity, however, must be chosen appropriately when using synchronous filters (see below).

Synchronous Filters

Even if the input signal has no noise, the PSD output always contains a component at $2f$ (sum frequency of signal and reference) whose amplitude equals or exceeds the desired dc output depending upon the phase. At low frequencies, the time constant required to attenuate the $2f$ component can be quite long. For example, at 1 Hz, the $2f$ output is at 2 Hz and to attenuate the 2 Hz by 60 dB in two stages requires a time constant of 3 seconds.

A synchronous filter, on the other hand, operates totally differently. The PSD output is averaged over a complete cycle of the reference frequency. The result is that all components at multiples of the reference ($2f$ included) are notched out completely. In the case of a clean signal, almost no additional filtering would be required. This is increasingly useful the lower the reference frequency. Imagine what time constant would be needed at 0.001 Hz!

In the SR860, synchronous filters are available at detection frequencies up to 4.8 kHz. At higher frequencies, synchronous filters are not required because $2f$ is easily removed with the other lowpass filters. The synchronous filter is applied after the other lowpass filters have removed the noise components from the PSD output leaving, just the synchronous signals for the synchronous filter to remove. This combination of filters removes all multiples of the reference frequency and provides overall noise attenuation as well.

Synchronous Filters and Sensitivity

It is important to note that the synchronous filter requires the Sensitivity to be set appropriately. This is because the synchronous filter is an integer filter and requires the floating point output to be converted to integer values. This conversion is based upon the Sensitivity. The output of the synchronous filter is then converted back to floating point. Choose a Sensitivity as if you will be using the analog X and Y outputs. This will typically result in the optimum scale. If the Sync filters are overloaded, the Sync error indicators on the display will light.

Outputs and Scales

The SR860 has X and Y outputs on the rear panel and Channel 1 and 2 (CH1 and CH2) outputs on the front panel.

X and Y Rear Panel Outputs

The X and Y rear panel outputs are the outputs from the two phase sensitive detectors with low pass filtering, offset and expand. These outputs are the traditional outputs of an analog lock-in. The X and Y outputs update at 2.222 MHz.

CH1 and CH2 Front Panel Outputs

The two front panel outputs can be configured to output voltages proportional to X or R and Y or θ . These outputs update at 2.222 MHz.

If the outputs are set to X or Y, these outputs duplicate the rear panel outputs.

X, Y, R and θ Output Scales

The Sensitivity setting of the SR860 determines what input signal corresponds to 10 V full scale output for X, Y and R. For example, a Sensitivity of 100 mV means that a signal at f_{ref} of 100 mV_{rms} will result in a 10 V output of R. X and Y will reach a maximum of 10 V, and a minimum of -10 V, depending upon the phase of the signal.

The Sensitivity also sets the scale for the displayed bar graphs and numeric readouts.

If the signal input exceeds the sensitivity, the outputs will overload. The actual measurement is typically unaffected since it is done in floating point and has no overload. The data displayed in the chart will still be accurate, provided the Sync filter is not overloaded.

Lock-in amplifiers are designed to measure the RMS value of the ac input signal. All values of X, Y and R outputs and displays are RMS values.

θ ranges from -180° to $+180^\circ$ regardless of the sensitivity or range. When CH2 outputs a voltage proportional to θ , the output scale is $18^\circ/\text{Volt}$ or $180^\circ=10\text{ V}$. The phase bar graph and numeric readout scales are also unaffected by the Sensitivity.

X, Y and R Output Offset, Ratio and Expand

The SR860 has the ability to offset the X, Y and R outputs. This is useful when measuring deviations in the signal around some nominal value. The offset can be set so that the output is offset to zero. Changes in the output can then be read directly from the display or output voltages. The offset is specified as a percentage of the Sensitivity and the percentage does not change when the Sensitivity is changed. Offsets up to $\pm 999\%$ can be programmed.

The X, Y, and R outputs may also be rescaled with a ratio function. This allows signals to be normalized to some experimental parameter being monitored with an auxiliary input voltage. Whenever enabled, ratio is indicated by the **RATIO** LED and “Ratio” labels on the display.

The X, Y and R outputs may also be expanded. This simply takes the output (minus its offset) and multiplies by an expansion factor. Thus, a signal which is only 10% of sensitivity can be expanded to provide 10 V of output rather than only 1 V. The normal use for expand is to expand the measurement resolution around some value which is not zero. For example, suppose a signal has a nominal value of 0.9 mV and we want to measure small deviations, say 10 μV or so, in the signal. The Sensitivity of the lock-in is set to 1 mV to accommodate the nominal signal. If the offset is set to 90% of full scale, then the nominal 0.9 mV signal will result in a zero output. The 10 μV deviations in the signal only provide 100 mV of dc output. If the output is expanded by 10, these small deviations are magnified by 10 and provide outputs of 1 VDC.

The SR860 can expand the output by 10 or 100 provided the expanded output does not exceed 10 V. In the above example, the 10 μV deviations can be expanded by 100 times before they exceed full scale (at 1 mV Sensitivity).

The analog output with offset, ratio and expand is

$$\text{Output} = \left[\frac{\frac{\text{X, Y, or R}}{\text{Sensitivity}} - \text{Offset}}{\left(\frac{\text{Ratio In}}{1.000\text{ V}} \right)} \right] \times \text{Expand} \times 10\text{V}$$

where Offset is a fraction of 1 ($50\%=0.5$), Expand is 1, 10 or 100, and the output cannot exceed 10 V. When enabled, Ratio In is the voltage on either Aux 3 (for X or Y) or Aux 4 (for R); if disabled, the Ratio In factor is simply 1. In the above example (without ratio),

$$\text{Output} = (0.91\text{mV}/1\text{mV} - 0.9) \times 10 \times 10\text{V} = 1\text{V}$$

for a signal which is 10 μV greater than the 0.9 mV nominal. (Offset = 0.9 and expand = 10).

The X and Y offset, ratio and expand functions in the SR860 are output functions and do not affect the calculation of R or θ . R has its own output offset, ratio and expand. θ has no offset or ratio or expand capability. To offset θ , simply use Auto Phase.

X, Y and R Display Offset and Ratio

Output offsets and ratios *are* reflected in the displays. For example, when the X output is offset to zero, the displayed value will drop to zero also. This means that the bar graph and numeric readout both drop to zero. In addition, if X is being charted on the graph, its graph will drop to zero. Any display which is showing a quantity which is affected by a non-zero offset will display a highlighted Offset indicator within its display. Similarly, any display which is showing a quantity affected by a non-unity ratio factor will display a highlighted Ratio indicator within its display. Remote queries of offset and/or ratioed quantities are also affected by the offset or ratio.

X, Y and R Display Expand

Output expands do *not* increase the displayed numeric values of X, Y or R. Expand increases the **resolution** of the displayed X, Y or R numeric value. This is because the expand function increases the resolution of the output, not the size of the input signal. The displayed value will show an increased resolution but will continue to display the original value minus the offset. Any display which is showing a quantity which is affected by a non-unity expand will display a highlighted Expand indicator within its display.

Output expands affect the bar graphs. The bar graphs are simply a visualization of the BNC outputs and as such are expanded to provide more visual resolution.

Output expands do not affect the strip charts. The values being charted are already floating point numbers with all of the resolution available. The strip charts do reflect the offsets however.

What is Dynamic Reserve Really?

Suppose the lock-in input consists of a signal at f_{ref} plus noise at some other frequencies. The real world definition of dynamic reserve is the ratio of the largest noise signal to the actual signal (at f_{ref}). This ratio is usually expressed in dB. For example, if the f_{ref} signal is 1 μV and the noise reaches 1 mV, then the dynamic reserve is 60 dB (noise is 1000 times the signal).

Dynamic reserve is therefore a property of the input signal generated by the experiment; that is, the ratio of noise to signal at the BNC is determined by factors outside the lock-in. It is the job of the lock-in to measure the signal to the best of its ability, whatever the ratio of noise to signal at the input. Of course, it is always better to have less noise and more signal!

Dynamic Reserve in the SR860

Unlike most lock-ins, the SR860 does not have a dynamic reserve setting. As mentioned above, the real world dynamic reserve is the noise to signal ratio at the input. The SR860 is designed to achieve the best possible measurement as easily as possible.

In the SR860 the only real gain is in the input amplifier, which amplifies the signal before it reaches the A/D converter. After this point, the signal is processed digitally so there's no further gain. Therefore, the only question is how to set the gain of the input amplifier.

In principle, the gain only needs to be high enough such that the input noise of the signal and the amplifier is greater than the input noise of the A/D converter. Increasing the analog gain beyond this point will not reduce the output noise.

Input Range

The Input Range sets the analog gain in the SR860. The settings reflect the largest signal at the input before the amplifier overloads. Setting the Input Range to a smaller value increases the analog gain. The signal strength LEDs on the front panel indicate how much of the A/D range is being used. The general rule is to decrease the Input Range as much as possible without overloading the amplifier. This increases the A/D range used and optimizes the output noise performance of the lock-in. At an Input Range of 10 mV no additional gain is available since noise performance will not improve with more gain.

Remember, we have defined dynamic reserve as a property of the input signal generated by the experiment. The ratio of noise to signal at the BNC is determined by factors outside the lock-in. The Input Range must be set to accommodate the largest signal present at the input, whether it is at f_{ref} or is just noise. Once the Input Range is set, use the Time Constant filters to achieve the best results. Then set the Sensitivity to optimize the bar graphs and numeric displays as well as the X, Y and R outputs.

The Input Amplifier

A lock-in can measure signals as small as a few nanovolts. A low noise signal amplifier is required to boost the signal to a level where the A/D converter can digitize the signal without degrading the signal to noise. The analog gain in the SR860 ranges from roughly 1 to 100. As discussed previously, higher gains do not improve signal to noise and are not necessary. The gain is set by the Input Range.

What is the Noise Floor?

The input noise of the SR860 signal amplifier is about 2.5 nVrms/ $\sqrt{\text{Hz}}$. What does this noise figure mean? Let's set up an experiment. If the SR860's Input Range is set to 10 mV then the input gain is sufficient that the noise floor of the measurement is determined by the input noise. Suppose the PSD output is low pass filtered with a single RC filter (6 dB/oct roll off) with a time constant of 100 ms. What will be the noise floor of the measurement?

Amplifier input noise and Johnson noise of resistors are Gaussian in nature. That is, the amount of noise is proportional to the square root of the bandwidth in which the noise is measured. A single stage RC filter has an equivalent noise bandwidth (ENBW) of $1/(4T)$ where T is the time constant ($R \times C$). This means that Gaussian noise is filtered with an effective bandwidth equal to the ENBW. In this example, a single 100ms low-pass filter has an ENBW of $1/(4 \times 100\text{ms})$ or 2.5 Hz. Thus the lock-in noise floor will be $2.5 \text{ nVrms}/\sqrt{\text{Hz}} \times \sqrt{2.5\text{Hz}}$ or $\sim 4 \text{ nVrms}$. For Gaussian noise, the peak to peak noise is about 5 times the rms noise. Thus, the output will have about 20 nV pk-pk of noise.

Remember that the SR860 reports its measurements in Volts referred to the input BNC. In this case, the SR860 will appear to have 20 nV pk-pk of noise at f_{ref} at the input, with its input grounded and no signal even applied. If this noise floor is too large for your experiment, then you need to add more filter stages or increase the time constant to decrease the ENBW.

All of this assumes that the signal input is being driven from a low impedance source. Remember resistors have Johnson noise equal to $0.13 \times \sqrt{R} \text{ nVrms}/\sqrt{\text{Hz}}$. Even a 50 Ω resistor has almost 1 nVrms/ $\sqrt{\text{Hz}}$ of noise. A signal source impedance of 400 Ω will have a Johnson noise greater than the SR860's input noise. To determine the overall noise of multiple noise sources, take the square root of the sum of the squares of the individual noise figures. For example, if a 400 Ω source impedance is used its Johnson noise will be 2.6 nVrms/ $\sqrt{\text{Hz}}$. The overall noise at the SR860 input will be $[(2.6)^2 + (2.5)^2]^{1/2}$ or 3.6 nVrms/ $\sqrt{\text{Hz}}$.

We'll talk more about noise sources later in this section.

At lower gains (Input Ranges above 10 mV), there is not enough gain to amplify the input noise to a level greater than the noise of the A/D converter. In these cases, the apparent input noise increases with the Input Range. For example, the configuration above will appear to have 30 nV pk-pk noise at the input when the Input Range is set to 100 mV and 250 nV pk-pk when the Input Range is 1 V. This means that even with 1 V of interfering noise, the SR860 can measure f_{ref} signals below 1 μV by increasing the amount of low pass filtering.

Anti-aliasing Filter

Between the input amplifier and A/D converter there is an anti-aliasing filter. This filter is required by the signal digitization process. According to the Nyquist criterion, signals must be sampled at a frequency at least twice the highest signal frequency. In this case, the highest signal frequency is 500 kHz and the sampling frequency is 10 MHz so things are OK. However, no signals above 5 MHz can be allowed to reach the A/D converter. These signals would violate the Nyquist criterion and be undersampled. The result of this undersampling is “aliasing”: these higher frequency signals appear as lower frequencies in the digital data stream. Thus a signal at 9.8 MHz would appear as 200 kHz in the digital data stream and be detectable by the digital PSD. This would be a problem.

To avoid this aliasing, the analog signal is filtered to remove any signals above 4 MHz. This filter has a flat pass band from dc to 3 MHz so as not to affect measurements in the operating range of the lock-in. The filter rolls off rapidly from 4 MHz to 6 MHz. Amplitude variations and phase shifts due to this filter are calibrated out at the factory and do not affect measurements. This filter is transparent to the user.

Input Impedance

The input impedance of the SR860 is 10 M Ω . If a higher input impedance is desired, then a preamplifier such as the SR550 or SR551 must be used. The SR550 has an input impedance of 100 M Ω and is ac coupled from 1 Hz to 100 kHz, while the SR551 has an input impedance of > 1 T Ω and is dc coupled with 1 MHz bandwidth.

Input Connections

In order to achieve the best accuracy for a given measurement, care must be taken to minimize the various noise sources that can be found in the laboratory. With intrinsic noise (Johnson noise, 1/f noise or input noise), the experiment or detector must be designed with these noise sources in mind. These noise sources are present regardless of the input connections. The effect of noise sources in the laboratory (such as motors, signal generators, etc.) and the problem of differential grounds between the detector and the lock-in can be minimized by careful input connections.

There are two basic methods for connecting a voltage signal to the lock-in. The single-ended connection is more convenient, while the differential connection eliminates spurious pick-up more effectively.

Single-Ended Voltage Connection (A)

In the first method, the lock-in uses the A input in a single-ended mode. The lock-in detects the signal as the voltage between the center and outer conductors of the A input only. The lock-in does not force the shield of the A cable to ground, rather it is internally connected to the lock-in's ground via a resistor. The value of this resistor is selected by the user. Float uses 10 k Ω and Ground uses 10 Ω . This avoids ground loop problems between the experiment and the lock-in due to differing ground potentials. The lock-in lets the shield ‘quasi-float’ in order to sense the experiment ground. However, noise pickup on the shield will appear as noise to the lock-in. This is bad since the input amplifier cannot reject this noise. Common mode noise, which appears on both the center and shield, is rejected by the common-mode rejection of the lock-in input, but noise on only the shield is not rejected at all.

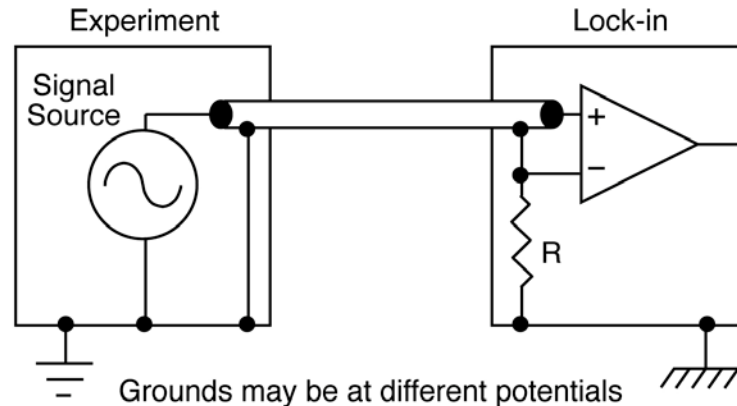

Differential Voltage Connection (A-B)

The second method of connection is the differential mode. The lock-in measures the voltage difference between the center conductors of the A and B inputs. Both of the signal connections are shielded from spurious pick-up. Noise pickup on the shields does not translate into signal noise since the shields are ignored. The shields of A and B are connected together and can set to Float or Ground as above.

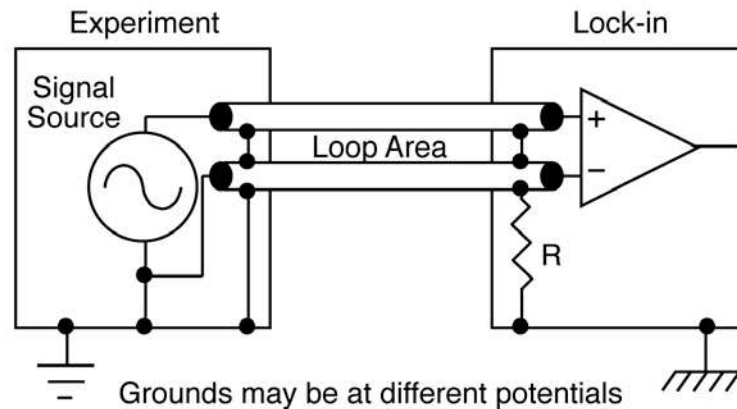

When using two cables, it is important that both cables travel the same path between the experiment and the lock-in. In particular, there should not be a large loop area enclosed by the two cables. Large loop areas are susceptible to magnetic pickup.

Common Mode Signals

Common mode signals are those signals which appear equally on both center and shield (A) or on the center of both A and B (A-B). With either connection scheme, it is important to minimize both the common mode noise and the common mode signal. Notice that the signal source is held near ground potential in both illustrations above. If the signal source floats at a nonzero potential, the signal which appears on both the A and B inputs will not be perfectly cancelled. The common mode rejection ratio (CMRR) specifies the degree of cancellation. For low frequencies, a CMRR of 100 dB indicates that the common mode signal is canceled to 1 part in 10^5 . Even with a CMRR of 100 dB, a 100 mV common mode signal behaves like a $1 \mu\text{V}$ differential signal! This is especially bad if the common mode signal is at the reference frequency (this often happens due to

ground loops). The CMRR decreases by about 6 dB/octave (20 dB/decade) starting at around 1 kHz.

ac vs dc Coupling

The signal input can be either ac or dc coupled. The ac coupling passes signals above 160 mHz (0.16 Hz) and attenuates signals at lower frequencies. ac coupling also degrades the common mode rejection of differential inputs.

At low signal frequencies, dc coupling is required.

A dc signal, if not removed by the ac coupling filter, will multiply with the reference sine wave and produce a PSD output at the reference frequency (sometimes referred to as 1f). This signal is not normally present and needs to be removed by the low pass filter. If the dc component of the signal is large, then this output will be large and require a long time constant or synchronous filter to remove. ac coupling removes the dc component of the signal without any sacrifice in signal as long as the frequency is above 160 mHz.

Current Input (I)

The current input on the SR860 uses a separate input BNC. The current input has a gain of either 10^6 or 10^8 Volts/Amp (1 μ A or 10 nA range). The input burden resistance is either 100 Ω (1 μ A range) or 1 k Ω (10 nA range). Currents from 3 μ A down to 1 fA full scale can be measured.

The impedance of the signal source is the most important factor to consider in deciding between voltage and current measurements.

For high source impedances, greater than 1 M Ω (1 μ A range) or 100 M Ω (10 nA range), and small currents, use the current input. Its relatively low input impedance greatly reduces the amplitude and phase errors caused by the cable capacitance-source impedance time constant. The cable capacitance should still be kept small to minimize the high frequency noise gain of the current preamplifier.

For moderate to low source impedances, or larger currents, the voltage input is preferred. A small value resistor may be used to shunt the signal current and generate a voltage signal. The lock-in then measures the voltage across the shunt resistor. Select the resistor value to keep the shunt voltage small (so it does not affect the source current) while providing enough signal for the lock-in to measure.

Which current range should you use? The current range determines the input current noise of the lock-in as well as its measurement bandwidth. Signals far above the input bandwidth are attenuated by 6 dB/oct. The noise and bandwidth are listed below.

<u>Range</u>	<u>Input Noise</u>	<u>Bandwidth</u>
1 μ A	130 fA/ $\sqrt{\text{Hz}}$	400 kHz
10 nA	13 fA/ $\sqrt{\text{Hz}}$	2 kHz

The current to voltage preamplifier is always dc coupled.

Intrinsic (Random) Noise Sources

Random noise finds its way into experiments in a variety of ways. Good experimental design can reduce these noise sources and improve the measurement stability and accuracy.

There are a variety of intrinsic noise sources which are present in all electronic signals. These sources are physical in origin.

Johnson Noise

Every resistor generates a noise voltage across its terminals due to thermal fluctuations in the electron density within the resistor itself. These fluctuations give rise to an open-circuit noise voltage,

$$V_{\text{noise}}(\text{rms}) = \sqrt{4kTR\Delta f}$$

where k =Boltzmann's constant (1.38×10^{-23} J/K), T is the temperature in kelvins (typically 300 K), R is the resistance in ohms, and Δf is the bandwidth in hertz. Δf is the equivalent noise bandwidth of the measurement.

Since the input signal amplifier in the SR860 has a bandwidth of approximately 4 MHz, the effective noise at the amplifier input is $V_{\text{noise}} = 250\sqrt{R}$ nV_{rms} or $1.3\sqrt{R}$ μ V pk-pk. This noise is broadband and if the source impedance of the signal is large, can determine the required Input Range of the lock-in.

The amount of noise measured by the lock-in is determined by the measurement bandwidth. Remember, the lock-in does not narrow its detection bandwidth until after the phase sensitive detectors. In a lock-in, the equivalent noise bandwidth (ENBW) of the low pass filter (time constant) sets the detection bandwidth. In this case, the measured noise of a resistor at the lock-in input, typically the source impedance of the signal, is simply

$$V_{\text{noise}}(\text{rms}) = 0.13\sqrt{R}\sqrt{\text{ENBW}}\text{nV}$$

where R is in ohms and ENBW is in hertz. The ENBW is determined by the time constant (T) and slope as shown below (for normal RC type filters).

<u>Slope</u>	<u>ENBW</u>
6 dB/oct	$1/(4T)$
12 dB/oct	$1/(8T)$
18 dB/oct	$3/(32T)$
24 dB/oct	$5/(64T)$

The signal amplifier bandwidth determines the amount of broadband noise that will be amplified. This affects the Input Range (analog signal gain). The time constant sets the amount of post-demodulation noise which will be measured at the reference frequency.

1/f Noise

Every 10 Ω resistor, no matter what it is made of, has the same Johnson noise. However, there is excess noise in addition to Johnson noise which arises from fluctuations in resistance due to the current flowing through the resistor. For carbon composition resistors, this is typically 0.1 μV -3 μV of rms noise per Volt of applied across the resistor. Metal film and wire-wound resistors have about 10 times less noise. This noise has a 1/f spectrum and makes measurements at low frequencies more difficult.

Other sources of 1/f noise include noise found in vacuum tubes and semiconductors.

Shot Noise

Electric current has noise due to the finite nature of the charge carriers. There is always some non-uniformity in the electron flow which generates noise in the current. This noise is called shot noise. This can appear as voltage noise when current is passed through a resistor, or as noise in a current measurement. The shot noise or current noise is given by

$$I_{\text{noise}}(\text{rms}) = \sqrt{2qI\Delta f}$$

where q is the electron charge (1.6×10^{-19} coulomb), I is the RMS ac current or dc current depending upon the circuit, and Δf is the bandwidth.

When the current input of a lock-in is used to measure an ac signal current, the bandwidth is typically so small that shot noise is not important.

Total Noise

All of these noise sources are incoherent. The total random noise is the square root of the sum of the squares of all the incoherent noise sources.

External Noise Sources

In addition to the intrinsic noise sources discussed previously, there are a variety of external noise sources within the laboratory.

Most of these noise sources are asynchronous, i.e. they are not related to the reference and do not occur at the reference frequency or its harmonics. Examples include lighting fixtures, motors, cooling units, radios, computer screens, etc. These noise sources affect the measurement by increasing the required dynamic reserve or lengthening the time constant.

Some noise sources, however, are related to the reference and, if picked up in the signal, will add or subtract from the actual signal and cause errors in the measurement. Typical sources of synchronous noise are ground loops between the experiment, detector and lock-in, and electronic pick up from the reference oscillator or experimental apparatus.

Many of these noise sources can be minimized with good laboratory practice and experiment design. There are several ways in which noise sources are coupled into the signal path.

Capacitive coupling

An ac voltage from a nearby piece of apparatus can couple to a detector via a stray capacitance. Although C_{stray} may be very small, the coupled noise may still be larger than a weak experimental signal. This is especially troublesome if the coupled noise is synchronous (at the reference frequency).

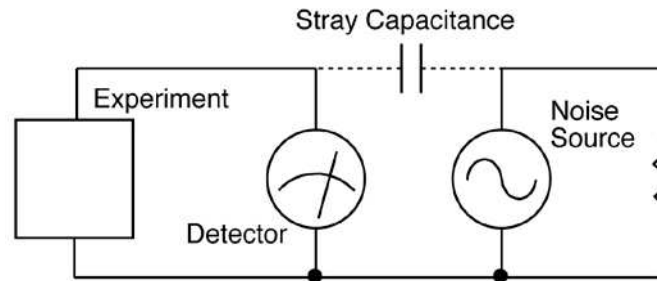

We can estimate the noise current caused by a stray capacitance by:

$$i = C_{\text{stray}} \frac{dV}{dt} = \omega C_{\text{stray}} V_{\text{noise}}$$

where ω is 2π times the noise frequency, V_{noise} is the noise amplitude, and C_{stray} is the stray capacitance.

For example, if the noise source is a power circuit, then $f = 60$ Hz and $V_{\text{noise}} = 120$ V. C_{stray} can be estimated using a parallel plate equivalent capacitor. If the capacitance is roughly an area of 1 cm^2 separated by 10 cm, then C_{stray} is 0.009 pF. The resulting noise current will be 400 pA (at 60 Hz). This small noise current can be thousands of times larger than the signal current. If the noise source is at a higher frequency, the coupled noise will be even greater.

If the noise source is at the reference frequency, then the problem is much worse. The lock-in rejects noise at other frequencies, but pick-up at the reference frequency appears as signal!

Cures for capacitive noise coupling include:

- 1) Removing or turning off the noise source.
- 2) Keeping the noise source far from the experiment (reducing C_{stray}). Do not bring the signal cables close to the noise source.
- 3) Designing the experiment to measure voltages with low impedance (noise current generates very little voltage).
- 4) Installing capacitive shielding by placing both the experiment and detector in a grounded metal box.

Inductive coupling

An ac current in a nearby piece of apparatus can couple to the experiment via a magnetic field. A changing current in a nearby circuit gives rise to a changing magnetic field which induces an emf ($d\Phi_B/dt$) in the loop connecting the detector to the experiment. This is like a transformer with the experiment–detector loop as the secondary winding.

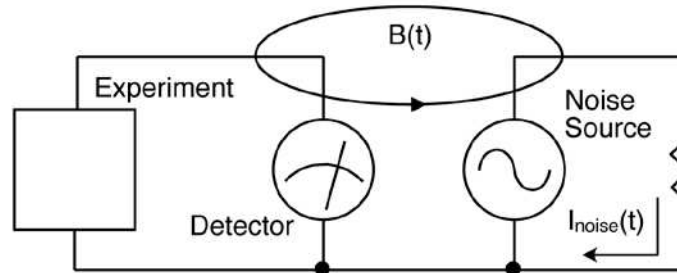

Cures for inductively coupled noise include:

- 1) Removing or turning off the interfering noise source.
- 2) Reduce the area of the pick-up loop by using twisted pairs or coaxial cables, or even twisting the 2 coaxial cables used in differential connections.
- 3) Using magnetic shielding to prevent the magnetic field from crossing the area of the experiment.
- 4) Measuring currents, not voltages, from high impedance detectors.

Resistive coupling or ground loops

Currents flowing through the ground connections can give rise to noise voltages. This is especially a problem with reference frequency ground currents.

In this illustration, the detector is measuring the signal relative to a ground far from the rest of the experiment. The experiment senses the detector signal plus the voltage due to the noise source's ground return current passing through the finite resistance of the ground between the experiment and the detector. The detector and the experiment are grounded at different places which, in this case, are at different potentials.

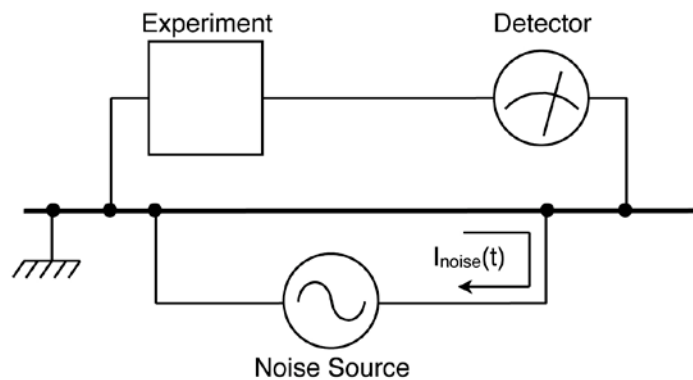

Cures for ground loop problems include:

- 1) Grounding everything to the same physical point.

- 2) Using a heavy ground bus to reduce the resistance of ground connections.
- 3) Removing sources of large ground currents from the ground bus used for small signals.
- 4) Using differential excitation and signal sensing.

Microphonics

Not all sources of noise are electrical in origin. Mechanical noise can be translated into electrical noise by microphonic effects. Physical changes in the experiment or cables (due to vibrations for example) can result in electrical noise over the entire frequency range of the lock-in.

For example, consider a coaxial cable connecting a detector to a lock-in. The capacitance of the cable is a function of its geometry. Mechanical vibrations in the cable translate into a capacitance that varies in time, typically at the vibration frequency. Since the cable is governed by $Q=CV$, taking the derivative, we have

$$C \frac{dV}{dt} + V \frac{dC}{dt} = \frac{dQ}{dt} = i$$

Mechanical vibrations in the cable which cause a dC/dt will give rise to a current in the cable. This current affects the detector and the measured signal.

Some ways to minimize microphonic signals are:

- 1) Eliminate mechanical vibrations near the experiment.
- 2) Tie down cables carrying sensitive signals so they do not move.
- 3) Use a low noise cable that is designed to reduce microphonic effects.

Thermocouple effects

The emf created by junctions between dissimilar metals can give rise to many microvolts of slowly varying potentials. This source of noise is typically at very low frequency since the temperature of the detector and experiment generally changes slowly. This effect is large on the scale of many detector outputs and can be a problem for low frequency measurements, especially in the mHz range.

Some ways to minimize thermocouple effects are:

- 1) Hold the temperature of the experiment or detector constant.
- 2) Use a compensation junction, i.e. a second junction in reverse polarity which generates an emf to cancel the thermal potential of the first junction. This second junction should be held at the same temperature as the first junction.

Noise Measurements

Lock-in amplifiers can be used to measure noise. Noise measurements are generally used to characterize components and detectors.

The SR860 measures input signal noise AT the reference frequency. Many noise sources have a frequency dependence which the lock-in can measure.

How Is Noise Measured?

Remember that the lock-in detects signals close to the reference frequency. How close? Input signals within the detection bandwidth set by the low pass filter time constant and roll-off appear at the output at a frequency $f = f_{\text{sig}} - f_{\text{ref}}$. Input noise near f_{ref} appears as noise at the output with a bandwidth of dc to the detection bandwidth.

For Gaussian noise, the equivalent noise bandwidth (ENBW) of a low pass filter is the bandwidth of the perfect rectangular filter which passes the same amount of noise as the real filter.

The ENBW is determined by the time constant (T) and slope as shown below (for normal RC type filters).

<u>Slope</u>	<u>ENBW</u>
6 dB/oct	$1/(4T)$
12 dB/oct	$1/(8T)$
18 dB/oct	$3/(32T)$
24 dB/oct	$5/(64T)$

The noise is simply the standard deviation (root of the mean of the squared deviations) of the measured X or Y values averaged over a period of time. This involves computing the average of $(X_{\text{value}} - X_{\text{mean}})^2$ where X_{value} is the current X output and X_{mean} is the mean X output. The noise result is the square root of the average. The averaging time is roughly 200 time constants; for example, if the time constant is 100 mS, the noise measurement would take about 20 seconds to settle.

If the Sync filter is enabled, that also affects the noise averaging time. The averaging time due to the Sync filter is 100 Sync filter periods. The final noise averaging time is the longer of these two averaging times, or 0.5 seconds.

Shorter averaging times yield a very poor estimate of the noise (the mean varies rapidly and the deviations are not averaged well). Longer averaging times, while yielding better results, take a long time to settle to a steady answer.

Noise and Sensitivity

Beginning with firmware version 1.20, noise is calculated using floating-point math, and it is independent of the Sensitivity setting.

However, earlier firmware versions used data from the scaled output values of X and Y. In order to accurately compute the noise on instruments running earlier firmware, the Sensitivity must be set appropriately so that the displayed values of X or Y have enough resolution. If the displayed values of X or Y are unchanging, then the computed noise will be almost zero.

Noise Display

To display a noise measurement, choose X or Y noise (Xn or Yn) as one of the displayed parameters in the [Config] screen. The SR860 is calculating the noise all of the time, whether or not X or Y noise are being displayed. Thus, as soon as noise is displayed, the

value shown is up to date and no settling time is required. If the time constant is changed, then the noise measurement will need to settle to the new value.

X and Y noise are displayed in units of V(rms). The ENBW of the time constant is NOT factored into the calculation. To convert to spectral noise density, divide the reading by $\sqrt{\text{ENBW}}$.

Chapter 3

Operation

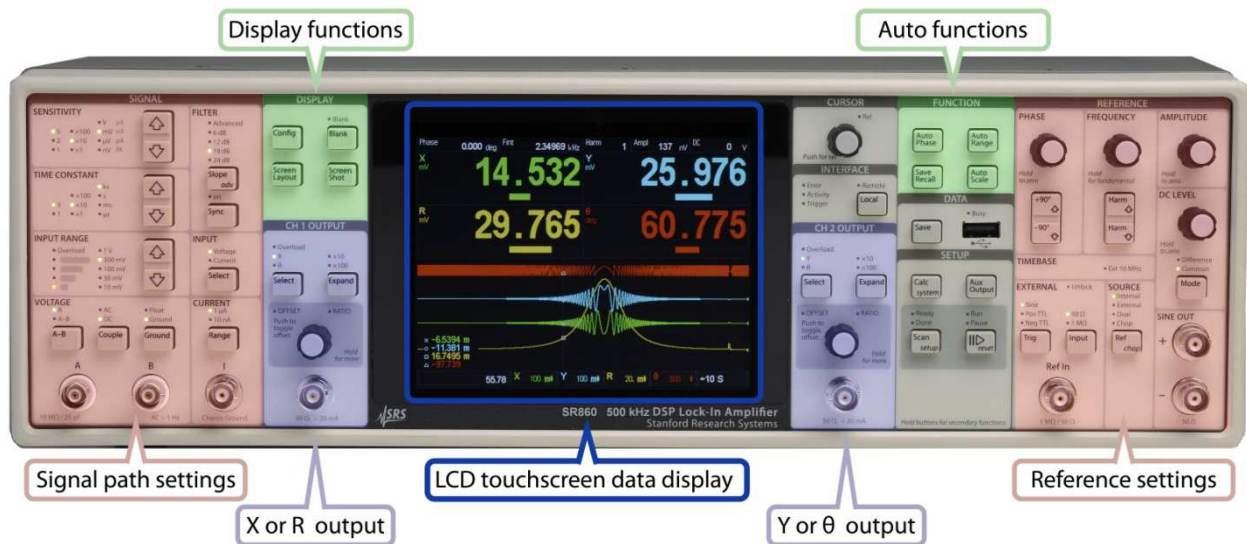

Introduction

Power

The power switch is on the rear panel. The SR860 is turned on by pushing the switch up.

Keys

The keys are grouped and labeled according to function. This manual will refer to a key with square brackets such as [Key]. A complete description of the keys follows in this section.

Knobs

Knobs are used to adjust the internal reference frequency, reference phase shift, sine output amplitude, sine dc level, offsets and Aux Output levels. The knobs also have secondary key-press functions labeled in *italics* below the knobs; these functions are accessed by pressing the knob inward. This manual will refer to knobs in angled brackets such as <Knob>.

Touchscreen Buttons

Touchscreen buttons on the display allow for direct keypad entry, text entry, calculator functions, graph scaling and much more. This manual will refer to touchscreen buttons with curly brackets such as {Button}.

Reset

To reset the unit, hold down the [Local] key while the power is turned on. The unit will use the standard settings. A similar reset is available without cycling power by pressing the [Save Recall] key and selecting {Recall default}.

Serial Number and Firmware Version

Press and hold [Local] and then [Auto Range] at the same time to display the unit serial number and version numbers. Press [Screen Layout] to dismiss the informational screen.

Local Lockout

If a computer interface has placed the unit in the Local Lockout state, indicated by the **Remote** LED, then the keys, knobs and touchscreen are disabled. Attempts to change the settings from the front panel will display a message indicating local control is locked out by the interface.

Reference Input

The reference input can be a sine wave (rising zero crossing detected) or a TTL pulse or square wave (rising or falling edge). The input impedance is either 1 M Ω or 50 Ω . The Sine Trig is ac coupled (>1 Hz). For low frequencies (<1 Hz), it is necessary to use a TTL reference signal. The TTL input provides the best overall performance and should be used whenever possible.

Sine Out

The internal oscillator outputs are differential with 50 Ω output impedance each. The output amplitude is specified as V_{rms} differential into 50 Ω loads (amplitude = sine+ – sine–). If the output is terminated in a high impedance, the amplitude will be double. If only a single output is used, the amplitude will be half. Thus a single output into high impedance will actually have the specified amplitude. The amplitude can be set from 1 n V_{rms} to 2 V_{rms} .

The dc level of the sine output can also be specified. The dc can be applied differentially (outputs move apart) or in common (outputs move together). The dc level can be set from 0.1 mV to 5 V. The maximum output is about ± 6 V.

These outputs are active even when an external reference is used. In this case, the sine wave is phase locked to the reference and its amplitude is programmable.

A 2.5 V sync logic output is provided on the rear panel via the configurable BlazeX output. This output is useful for triggering scopes and other equipment at the reference frequency. The sync output is a square wave derived from the zero crossings of the sine output.

CH1 & CH2 Outputs

The Channel 1 and Channel 2 outputs can be configured to output a voltage from -10 V to $+10\text{ V}$ proportional to X or R (CH1) and Y or θ (CH2). The sensitivity setting determines full scale ($\pm 10\text{ V}$).

Signal Inputs

The voltage input mode may be single-ended, A, or differential, A–B. The A and B inputs are voltage inputs with $10\text{ M}\Omega$, 25 pF input impedance. Their connector shields are isolated from the chassis by $10\ \Omega$ (Ground) or $1\text{ k}\Omega$ (Float). Do not apply more than 10 V to either input. The shields should never exceed 1 V .

The current input is configured for either $1\ \mu\text{A}$ or 10 nA current range. The input burden resistance is $100\ \Omega$ ($1\ \mu\text{A}$) or $1\text{ k}\Omega$ (10 nA) to a virtual ground.

Key Click On/Off

Press and hold the [Calc/system] key to display the system menu. Touch {Sounds} to toggle the key click on and off.

Display Off Operation

Press the [Blank] key to operate with the front panel display and LEDs off. The SR860 is still operating, the outputs are active, data collection continues and the unit responds to interface commands. To change a setting, press [Blank] to return to normal operation, change the desired parameter, then press [Blank] again.

Front Panel Test

To test the front panel, press and hold [Local] and [Auto Range] at the same time.

Turn any knob to run through all of the LEDs. Make sure all of the knobs and all of the LEDs work.

Touch and drag on the touchscreen to display a little trail. The bright end signifies the lift location. This verifies the touch functionality.

Press each key to toggle its position (green/gray) on the screen. Keys with a secondary press and hold function need to be held to toggle. The knobs also have a press and hold feature. Check to see that all keys and knobs function.

The [Screen Layout] key exits this screen.

Standard Settings

If the [Local] key is held down when the power is turned on, the lock-in settings will be set to the defaults shown below rather than the settings that were in effect when the power was last turned off. The default settings may also be recalled using the *RST command over the computer interface, or by pressing [Save Recall] and selecting {Recall default}. In this case, the communications parameters and status registers are not changed.

Reference

Phase	0.000°
Reference Source	Internal
Internal Frequency	100.000 kHz
Harmonic #	1
Sine Amplitude	0.00 Vrms
DC Level	0.0 V
Ext Reference Trigger	Sine
Ext Reference Impedance	50 Ω

Signal

Input	Voltage
A-B	A
Couple	AC
Ground	Float
Current Range	1 μ A
Input Range	1 V
Time Constant	100 ms
Filter Slope	6 dB
Advanced Filter	On
Synchronous	Off
Sensitivity	1 V

Outputs

CH1 Output	X
CH2 Output	Y
All Offsets	0.00%
All Expands	1
All Ratios	None
All Aux Outputs	0.000 V

Display

Green Channel	X, Graph On
Blue Channel	Y, Graph On
Yellow Channel	R, Graph On
Orange Channel	θ , Graph On
Screen Layout	Trend
Blank	No

System/General

10 Mhz Timebase	Auto
Sync/BlazeX Output	Sync
Sounds	On

System/Files

Prefix	SR865
Suffix	1
Print Mode	Screen
Data Format	CSV

Signal Input

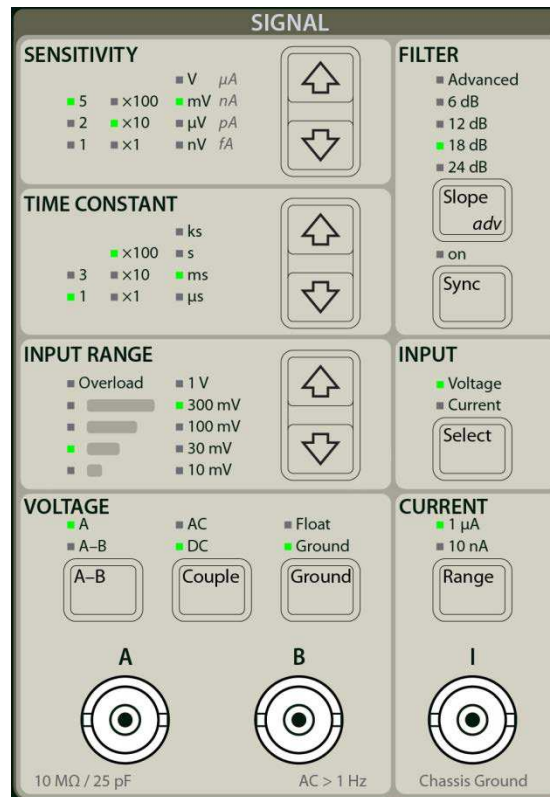

Input [Select]

The Input [Select] key selects between the voltage and current preamps.

The voltage inputs (A and B) have a 10 M Ω , 25 pF input impedance. Their connector shields are isolated from the chassis by either 10 Ω (Ground) or 10 k Ω (Float). Do not apply more than 10 V to either input. The shields should never exceed 1 V.

The current input uses the I connector. The input burden resistance is 100 Ω (1 μA range) or 1 k Ω (10 nA range) to a virtual ground. The largest allowable current before overload is around 3 μA (1 μA range) or 30 nA (10 nA range). No current larger than 10 mA should ever be applied to this input.

Voltage [A-B]

The voltage input can be either a single-ended (A) or differential (A-B) voltage. The shields of A and B are connected and grounded by either 10 Ω (Ground) or 10 k Ω (Float).

Voltage [Couple]

This key selects the voltage input coupling. The signal input can be either ac or dc coupled. The ac coupling option uses a high pass filter to pass signals above 160 mHz and attenuate signals at lower frequencies. ac coupling should be used at frequencies above 160 mHz whenever possible. At lower frequencies, dc coupling is required. ac

coupling results in gain and phase errors at low frequencies as well as reduced CMRR performance.

Remember, the Reference Input is ac coupled when a sine reference is used. This also results in phase errors at low frequencies.

Voltage [Ground]

This key chooses the shield grounding configuration. The shields of the input connectors (A and B) are not connected directly to the lock-in chassis ground. In Float mode, the shields are connected by 10 k Ω to the chassis ground. In Ground mode, the shields are connected by 10 Ω to ground. Typically, the shields should be grounded if the signal source is floating and floating if the signal source is grounded. Do not exceed 1 V on the shields.

Voltage [Input Range]

The voltage input range specifies the largest input signal (ac or dc coupled) before the voltage input is overloaded. The smaller the input range value, the higher the amplifier gain leading to the A/D converter. The signal strength LEDs indicate how much of the A/D range is being used. When the lowest yellow LED is on, try decreasing the input range (increasing the gain).

In general, use the smallest input range possible without overload. Remember, the largest signal, whether it's at f_{ref} or just noise, will be the first to overload.

This setting has no effect when the current input is selected.

The Signal Monitor on the rear panel is the amplifier output.

Current [Range]

The current input uses the I connector. The input burden resistance is 1 k Ω (10 nA range) or 100 Ω (1 μ A range) to a virtual ground. The shield is chassis ground. The largest allowable current (ac plus dc) before overload is approximately ± 4 μ A or ± 40 nA. No current larger than 10 mA should ever be applied to this input.

The current range determines the input current noise as well as the input bandwidth. The 10 nA range has 10 times lower noise but 200 times lower bandwidth. Be sure the signal frequency is below the input bandwidth limit. The noise and bandwidth are listed below.

<u>Range</u>	<u>Noise</u>	<u>Bandwidth</u>
1 μ A	130 fA/ $\sqrt{\text{Hz}}$	400 kHz
10 nA	13 fA/ $\sqrt{\text{Hz}}$	2 kHz

The impedance of the current source should be greater than 1 M Ω when using the 1 μ A range and greater than 100 M Ω when using the 10 nA range.

The signal strength LEDs indicate how much of the A/D range is being used. The Signal Monitor on the rear panel is the amplifier output.

The current range setting has no effect when the voltage input is selected.

Input Overload

The **Overload** LED in this section indicates an input overload. This occurs for voltage inputs greater than the voltage input range (unless removed by ac coupling) or current inputs exceeding $\pm 4 \mu\text{A}$ (1 μA range) or $\pm 40 \text{ nA}$ (10 nA range).

An input overload compromises the measurement of X, Y, R and θ . Any display of these quantities will be accompanied by an Ovld indication.

Either increase the input range or reduce the input signals to remove the overload.

Slew Rate

Overloads can also be caused by high slew rate voltage signals. These are large signals with fast rise or fall times. This can be a square wave (at any frequency) with fast transitions, or simply a large amplitude high frequency sine wave. In these cases, the amplifier may become slew rate limited and unable to accurately amplify other components of the signal. When this occurs, the **Overload** LED may light even though the signal strength indicator is not at its maximum. Once again, increase the input range or reduce the input signal.

[Time Constant]

The time constant may be set from 1 μs to 30 ks. The time constant is indicated by 1 or 3 times 1, 10 or 100 with the appropriate units.

This time constant sets the bandwidth of the low pass filter after the phase sensitive detectors for X and Y. This is the filter that removes signals at frequencies other than f_{ref} . In general, longer time constants provide more noise filtering and quieter measurements but longer response times.

The time constant also determines the equivalent noise bandwidth (ENBW) of the low pass filter. This is the measurement bandwidth for X and Y noise and depends upon the time constant and filter slope. (See the Noise discussion in the Basics section.)

In some experiments, output latency (delay from signal input to analog output) at short time constants is important. Use the rear panel BlazeX output for the lowest latency analog X output. Otherwise, the front panel outputs CH1 and CH2 as well as the rear panel X and Y outputs have sufficient bandwidth for all time constants.

Filter [Slope/adv]

This key selects the number of poles in the low pass filter. Choosing 6, 12, 18 or 24 dB/(oct) selects 1, 2, 3 or 4 poles. Using more poles can decrease the required time constant and make a measurement faster.

The normal low pass filter is an RC filter. This is equivalent to the traditional filter found in analog lock-ins.

To use advanced filters in place of the RC filters press and hold the [Slope/adv] key until the **Advanced** LED turns on. Brief presses of [Slope/adv] cycles the number of poles

from 1 to 4 (6 to 24 dB). Another press and hold of the [Slope/adv] key reverts the filters back to RC filters and turns off the **Advanced** LED.

For two filters with the same noise bandwidth, i.e. whose outputs would be equally noisy if the input was white noise, the advanced filters have faster transient response, less overshoot, and higher stopband attenuation to ensure greater suppression of out-of-band spurs.

When the time constant is 3 s or faster an advanced FIR filter pole of equivalent noise bandwidth (ENBW) is substituted for each RC filter pole.

For time constants of 10 s through 1000 s, the advanced filter is a Linear Phase (LP) filter with same attenuation slope as the RC filters of the same time constant and number of poles. In other words, the Linear Phase filter's stop band is aligned with the corresponding RC filter.

For time constants greater than 1000 s, the advanced filter is the same as the RC filter.

In an actual experimental situation, the signal is seldom simple. If the goal is to read a static output value, then longer time constants will achieve that. If the output value is changing because of parameter sweeping or a signal turning on and off, then the advanced filters can be of great help. In practice it is simple to try these filters, at various time constants and number of poles, in comparison with RC filters. They often yield better results in less time.

See Appendix A for more information about the advanced filters.

Filter [Sync]

Pressing this key turns synchronous filtering on or off.

Synchronous filtering removes outputs at harmonics of the reference frequency, most commonly $2 \times f_{\text{ref}}$. This is very effective at low reference frequencies since $2 \times f_{\text{ref}}$ outputs would require very long time constants to remove. The synchronous filter does not attenuate broadband noise very well. The low pass filters should be used to remove outputs due to noise and other non-harmonic interfering signals.

The synchronous filter computes moving averages of the X and Y outputs over a complete reference period, $1/f_{\text{ref}}$. In this way, outputs with periods $1/(n \times f_{\text{ref}})$ average to zero and are removed. Thus frequency components in the output at $n \times f_{\text{ref}}$ are all removed. The synchronous filter follows the normal low pass filters (time constant) and is applied at the outputs.

Sensitivity

In order for the synchronous filter to perform accurately, the sensitivity must be set appropriately. This is because the synchronous filter acts on the **output scaled** values of X and Y. If the sensitivity is set too high, the values of X and Y (in the numeric displays) will lack the necessary resolution. If the sensitivity is set too low, the values will overload. In general, setting the sensitivity to display a reasonable amount of bar graph is sufficient for accurate synchronous filtering. If the synchronous filter overloads because of the sensitivity, the Sync warning is displayed with displays of X, Y, R or θ .

Internal, External and Chop Reference

When the reference source is internal, external or chop, the synchronous filter period is $1/f_{ref}$ regardless of the harmonic detect number. The output is averaged over N periods of the detect frequency where N is the harmonic detect number. Synchronous filtering is only active when the reference frequency is 4.8 kHz or below. If the reference frequency is above 4.8 kHz and synchronous filtering is on, then a Sync error is displayed with displays of X, Y, R or θ indicating that the synchronous filter is not working as expected.

Dual Reference

When the reference source is dual, the synchronous filter period is a single period of the actual detect frequency $f_{dual} = |N_1 \times f_{int} - N_2 \times f_{ext}|$, where N_1 and N_2 are the internal harmonic and dual reference external harmonic detect numbers respectively. Synchronous filtering is only active when the actual detect frequency is 4.8 kHz or below. If the detect frequency is above 4.8 kHz and synchronous filtering is on, then a Sync error is displayed with displays of X, Y, R or θ indicating that the synchronous filter is not working as expected.

Settling Time

When the synchronous filter is active, the phase sensitive detectors (PSD's) are followed by the specified low pass filtering (time constant filter) and then the synchronous filter. This removes non-harmonic noise before the synchronous filter.

The settling time of the synchronous filter is one period of the filter (usually $1/f_{ref}$). Since the synchronous filter follows the phase sensitive detectors, the time constant filters and output scaling, any change in the signal amplitude, reference frequency, phase, time constant, slope or sensitivity will cause the outputs to settle for one period of the filter. These transients are because the synchronous filter provides a steady output only if its input is repetitive from period to period.

The transient response also depends upon the time constants of the regular filters. Very short time constants (\ll period) have little effect on the transient response. Longer time constants ($<$ period) can magnify the amplitude of a transient. Much longer time constants (\geq period) will increase the settling time far beyond a period.

[Sensitivity]

The Sensitivity setting of the SR860 determines what input signal corresponds to 10 V full scale output for X, Y and R. For example, a Sensitivity of 100 mV means that a signal at f_{ref} of 100 mVrms will result in a 10 V output of R. X and Y will reach a maximum of 10 V depending upon the phase of the signal.

The Sensitivity also sets the scale for the displayed bar graphs and numeric readouts.

Note that this is a numerical output conversion. Output overloads do not generally affect the actual measurement results! They only indicate that the output value exceeds 100% of the chosen Sensitivity and the output BNC, the bar graph and the displayed numerical readout will be pinned at their maximums. The results displayed on the strip charts or available over the computer interfaces are the floating point outputs and are unaffected by output overloads. Output overloads are indicated by a 'Scale' indicator in the X, Y or R displays.

The Sensitivity should be chosen to conveniently and accurately display the measurement results on the output BNC, the bar graph and the numerical readout. The Sync filter also uses the Sensitivity as an indicator of the signal range it needs to accommodate. An output overload does not necessarily mean a Sync filter overload, but a 'Sync' error indicated in the X, Y, R or θ displays does signify a Sync filter overload.

θ ranges from -180° to $+180^\circ$ regardless of the scale or range. When CH2 outputs a voltage proportional to θ , the output scale is $18^\circ/\text{Volt}$ or $180^\circ=10\text{ V}$. The phase bar graph and numeric readout scales are also unaffected by the Sensitivity.

Synchronous Filters and Noise Calculations

Synchronous filtering and calculation of X_{noise} and Y_{noise} are performed on the output scaled values of X and Y. Thus, their accuracy is affected by a poor choice of Sensitivity. If the Sensitivity is set too large, the values of X and Y (in the numeric displays) will lack the necessary resolution. If the Sensitivity is set too low, the values will be overloaded (pinned) and no noise will be measured. In general, setting the Sensitivity to display a reasonable amount of bar graph is sufficient.

CH1 and CH2 Outputs: Offset, Ratio and Expand

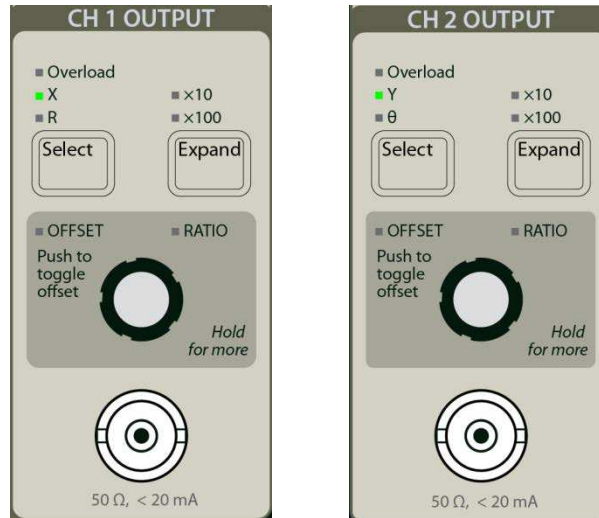

Analog Outputs

Analog voltages proportional to X, Y, R and θ can be output from the SR860. The X and Y rear panel outputs always output X and Y. The CH1 output voltage is proportional to either X or R. The CH2 output voltage is proportional to either Y or θ . The output voltages are determined by

$$\text{Output} = \left[\frac{\text{X, Y or R} - \text{Offset}}{\text{Sensitivity}} \times \frac{\text{Expand} \times 10\text{V}}{\left(\frac{\text{Ratio In}}{1.000\text{V}} \right)} \right]$$

The output is normally 10 V for an input signal equal to the sensitivity. The offset subtracts a percentage of full scale (up to $\pm 999\%$) from the output. Expand multiplies the difference by a factor of 1, 10 or 100. This result may be divided by a ratio input (Aux Input voltage). An Aux Input voltage of 1.000 V corresponds to unity.

Outputs which would exceed $\pm 10\text{V}$ generate an Output Overload and the red output **Overload** LED will light. Any corresponding displayed numeric value/bar graph will indicate 'Scale' in the display. The actual measurement is unaffected since it is done in floating point and has no overload. Data displayed in the strip chart will still be accurate.

The X and Y offset, expand and ratio functions in the SR860 are output functions, they do not affect the calculation of R or θ . R has its own output offset, expand and ratio.

Phase ranges from -180° to $+180^\circ$ regardless of the sensitivity. When CH2 outputs a voltage proportional to θ , the output scale is $18^\circ/\text{Volt}$ or $180^\circ = 10\text{V}$. The phase bar graph and numeric readout scales are also unaffected by the Sensitivity. Phase has no offset, ratio or expand capability. To offset phase, simply use Auto Phase. To expand phase, expand the value of Y in quadrature.

Offset

Output offsets are reflected in the displays. For example, when the X output is offset to zero, the displayed value will drop to zero also. This means that the bar graph and numeric readout both drop to zero. In addition, if X is being charted on the graph, its graph will drop to zero. Any display which is showing a quantity which is affected by a non-zero offset will display a highlighted Offset indicator within its display.

Ratio

The X, Y, and R may be normalized to an Aux Input voltage. This is called a ratio measurement. An output ratio is reflected in the displays. The numeric values, bar graphs and strip charts all reflect the normalized output. Any display which is showing a quantity which is affected by a ratio will display a highlighted Ratio indicator within its display.

Expand

Output expands do not increase the displayed numeric values of X, Y or R. Expand increases the *resolution* of the displayed X, Y or R numeric value. This is because the expand function increases the resolution of the output, not the size of the input signal. The displayed value will show an increased resolution but will continue to display the original value minus the offset. Any display which is showing a quantity which is affected by a non-unity expand will display a highlighted Expand indicator within its display.

Output expands affect the bar graphs. The bar graphs are simply a reflection of the BNC outputs and as such are expanded to provide more visual resolution.

Output expands do not affect the strip charts. The values being charted are already floating point numbers with all of the resolution available. The strip charts do reflect the offsets however.

See the SR860 Basics section for more information.

Output [Select]

This key selects the source for the CH1 (CH2) output BNC. CH1 can select either X or R. CH2 can select either Y or θ . This also determines which parameter's offset and expand are adjusted with the [Expand] key and the <Offset> knob.

Output [Expand]

Pressing this key selects the X or R Expand (CH1) or the Y Expand (CH2). Use the [Select] key to select either X or R (CH1) and Y or θ (CH2). θ cannot be expanded. To expand phase, expand the value of Y in quadrature.

The expand can be none ($\times 1$ or no expand), $\times 10$ or $\times 100$. If the expand is $\times 10$ or $\times 100$, the corresponding LED will light. The output can never exceed full scale (± 10 V) when expanded. An output expanded beyond full scale will be output overloaded.

Output <Offset>

Press this knob briefly to toggle the X or R offset (CH1) or the Y offset (CH2) on and off. Use the [Select] key to select either X or R (CH1) and Y or θ (CH2). The value of θ cannot be offset. Use Auto Phase to offset phase to zero.

This allows the offset to be turned on and off without adjusting the actual offset percentage.

The **OFFSET** LED is on when the offset is being applied.

Press and hold the <Offset> knob to display an offset keypad as shown below.

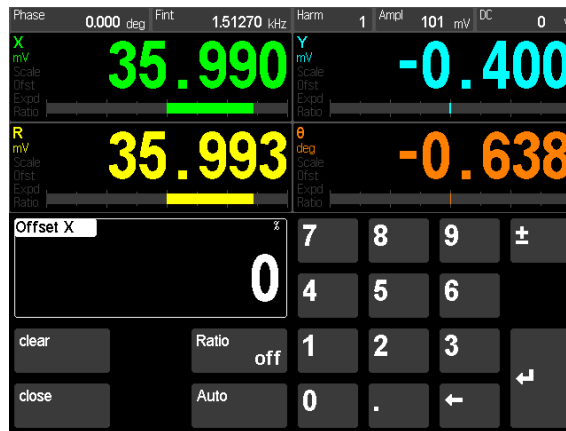

Touch {Auto} Offset to automatically adjust the X offset (or Y or R) such that X (or Y or R) becomes zero. Offsets can also be set using the keypad or by turning the <Offset> knob. Turning the knob ALWAYS adjusts the offset, even if the offset is toggled off and the keypad is not shown.

Offsets are set as a percentage of the Sensitivity up to $\pm 999\%$ ($10\times$). The offset percentage is not changed with the sensitivity — it is an output function.

Touch {Close} to dismiss the keypad.

Touch {Ratio} to cycle between Off (no ratio) and an Aux Input. The **RATIO** LED is on when a ratio is being applied.

Output Overload

Outputs which would exceed ± 10 V generate an Output Overload and the red **Overload** LED will light. Any corresponding displayed numeric value/bar graph will indicate 'Scale' in the display. The actual measurement is unaffected since it is done in floating point and has no overload. Data displayed in the strip chart will still be accurate.

Reference



Each of the data screens always displays a reference info bar across the top.

Phase	0.000 deg	Fint	100.000 kHz	Harm	1	Ampl	0 V	DC	0 V
-------	-----------	------	-------------	------	---	------	-----	----	-----

This bar always shows tiles displaying the reference phase, frequency, detected harmonic, sine out amplitude and dc level. Each of these parameters can be adjusted using the knobs and buttons in this section of the front panel.

Touching one of these tiles brings up a numeric keypad for direct entry.

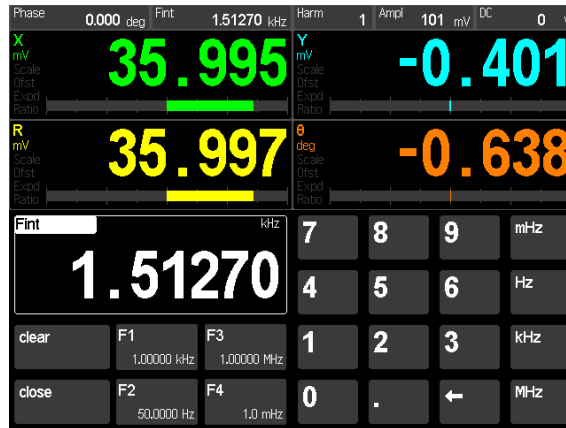

Numeric entry is straightforward. {Close} will return to the data screen. The buttons {F1}, {F2}, {F3} and {F4} are frequency presets. Touching a preset will load the preset value immediately. Touch and hold a preset button to memorize the current setting. Other parameters may have slightly different entry screens.

Source [Ref/chop]

Press this key briefly to cycle through the reference sources. Press and hold to display the SR540 Chopper setup screen (see Chop, below).

Internal

When the source is Internal, the SR860's synthesized internal oscillator is used as the reference. The Ref In BNC is ignored in this case. The internal frequency is shown in the info bar. Use the <Frequency> knob or the numeric keypad to adjust the frequency.

In this mode, the Sine Out is at the internal frequency.

External

When the source is External, the SR860 will phase lock to the external reference provided at the Ref In BNC. The SR860 will lock to frequencies between 0.001 Hz and 500 kHz. The external frequency is shown in the info bar. The <Frequency> knob has no effect on the external frequency.

In this mode, the Sine Out is at the external frequency.

Dual

When the source is Dual, the SR860 will detect signals at $f_{\text{detect}} = |f_{\text{int}} - f_{\text{ext}}|$ where f_{ext} is the external reference frequency and f_{int} is the internal frequency. The internal frequency is shown in the info bar. Use the <Frequency> knob or the numeric keypad to adjust the internal frequency.

In this mode, the Sine Out is at the internal frequency.

To record and view the external frequency, use the [Config] key to assign f_{ext} to one of the four data channels.

You can find more about dual reference mode in Appendix E (page 175).

Chop

When the source is Chop, the SR860 will phase lock an external SR540 Optical Chopper to the SR860's internal reference frequency. This is achieved by connecting the f Reference output from the SR540 to the Ref In of the SR860. But instead of using this input as the external reference, the SR860 will servo the SR540 to lock the SR540 to the SR860 internal frequency. This control is via a connection from the SR860 rear panel Aux Out 4 BNC to the CONTROL VOLTAGE input of the SR540.

This essentially transforms the SR540 into a frequency and phase stabilized chopper with the frequency accuracy and drift of the SR860. This is especially useful in experiments with multiple SR540 choppers. Each SR540 chopper (with its own SR860) can be synchronized to a common 10 MHz clock to achieve stable frequency and phase relationships with each other.

Lock-in detection is at the (measured) external frequency. The SR540 is driven to phase lock with this internal frequency, but is subject to the mechanical limitations of its motor and slew rate. The internal frequency is shown in the info bar. Use the <Frequency> knob or the numeric keypad to adjust the internal frequency. To record and view the external frequency, use the [Config] key to assign f_{ext} to one of the four data channels. By comparing f_{ext} and f_{int} , the effective settling time of the SR540 to commanded frequency changes can be observed.

In this mode, the Sine Out is at the external frequency.

Both the SR540 and the SR860 must be configured correctly in this mode. Press and hold the [Ref/chop] key to display the Chopper configuration screen.



Touch the Chopper Blade Slot Count setting to specify whether the 6/5 or 30/25 slot blade is mounted on the SR540 chopper head. Follow the directions to set the MAX FREQ and REFERENCE MODE switches on the SR540.

Connect the SR540 f/f_{DIFF} output (right hand BNC) to the SR860 Ref In BNC.

Connect the SR860 Aux Out 4 (rear panel BNC) to the SR540 CONTROL VOLTAGE input BNC.

Make sure that the SR860 External Trig is set to Pos TTL and the Input is 1 M Ω . Adjust the SR860 internal frequency to a value that the SR540 can reach with the selected blade.

The Phase setting in this screen is the ‘blade’ phase. This is the phase of the blade opening relative to the optical detector at the base of the chopper head. When a single chopper is being used, this is not important since the demodulator reference phase of the SR860 can be adjusted to maximize the signal. When using multiple choppers, this ‘blade’ phase can be used to align multiple chopped beams to arrive in phase together at the experiment. This would otherwise be done by moving the position of the chopper or beam.

The <Cursor> knob will also adjust the phase value in this screen.

External [Input]

This key sets the termination of the Ref Input BNC to either 50 Ω or 1 M Ω . Be careful that the termination does not excessively attenuate the signal or cause ringing on its edges.

External [Trig]

This key selects the external reference input trigger mode.

TTL

When either Pos TTL or Neg TTL is selected, the SR860 locks to the selected edge of a TTL square wave or pulse train. For reliable operation, the TTL signal should exceed +1.5 V when high and be less than +0.5 V when low. This trigger mode is dc coupled. This input mode should be used whenever possible since it is less noise prone than the sine wave discriminator.

For very low frequencies (<1 Hz), a TTL reference MUST be used.

Sine

Sine input trigger locks the SR860 to the rising zero crossings of an analog signal at the Ref In BNC. This signal should be a clean sine wave at least 200 mVpp in amplitude. In this input mode, the Ref In is ac coupled (above 1 Hz).

Sine reference mode cannot be used at frequencies far below 1 Hz. At very low frequencies, the TTL input modes must be used.

Unlock

In External or Dual reference source, the **Unlock** indicator turns on if the SR860 cannot lock to the external reference. This can be because the external reference amplitude is too low or the frequency is out of range.

In Chop reference, **Unlock** indicates that the SR540 chopper is unlocked. This can be because the switches on the SR540 are incorrectly configured or the blade is not turning freely.

Timebase

The SR860 has a 10 MHz TIMEBASE input and output on the rear panel. Apply a 10 MHz sine signal (1 V_{rms}) to the TIMEBASE input to lock the SR860's timebase to an external 10 MHz timebase. The internal reference frequency of the SR860 is derived from this timebase. When multiple SR860's are locked to the same 10 MHz timebase, then harmonically related internal frequencies on different units will stay in phase indefinitely.

The **Ext 10 MHz** LED is on when the unit is locked to an external timebase.

The SR860 can also output its own 10 MHz timebase to another unit.

Note that external function generators, even DDS locked to the same 10 MHz timebase, will not stay in perfect phase with the SR860. This is because the resolution of the frequency tuning word in the external synthesizer differs from the SR860.

<Phase>

This knob may be used to adjust the phase. The phase shift ranges from -180° to $+180^\circ$ with 0.001° resolution. Press and hold this knob to set the phase to zero.

The phase value is shown in the info bar at the top of the screen. Touch this {Phase} tile to show the numeric entry screen.

When using an external reference, the reference phase shift is the phase between the external reference and the digital sine wave which is multiplying the signal in the PSD. This is also the phase between the sine output and the digital sine wave used by the PSD in either internal or external reference mode. Changing this phase shift only shifts internal sine waves. The effect of this phase shift can only be seen at the lock-in outputs X, Y and θ . R is phase independent.

Auto Phase

Touching {Auto} in the numeric entry screen or pressing the [Auto Phase] key will adjust the reference phase shift so that the measured signal phase is 0° . This is done by subtracting the present measured value of θ from the reference phase shift. It will take several time constants for the outputs to reach their new values. Auto Phase may not result in a zero phase if the measurement is noisy or changing.

Phase [+90°] and [-90°]

The [+90°] and [-90°] keys add or subtract 90.000° from the reference phase shift.

Touching {+90°} and {-90°} in the phase numeric entry screen will do the same.

<Frequency>

If the reference source is Internal, Dual or Chop, this knob adjusts the internal reference frequency.

The internal frequency is shown in the info bar at the top of the screen. Touch the {F_{int}} tile to show the numeric entry screen.

The internal frequency has 6 digits or 0.1 mHz resolution, whichever is larger. The frequency can range from 1.0 mHz to 500 kHz. The upper limit is decreased if the harmonic number is greater than 1. In this case, the upper limit is 500 kHz/N where N is the harmonic number.

Press and hold this knob to set the harmonic detect to 1 (fundamental).

Frequency [Harm Up] and [Harm Down]

Pressing these keys increments and decrements the harmonic detect number from 1 to 99.

The harmonic number is shown in the info bar at the top of the screen. Touch this {Harm} tile to show the numeric entry screen.

The SR860 can detect signals at harmonics of the reference frequency. The SR860 multiplies the input signal with digital sine waves at $N \times f_{\text{ref}}$. Only signals at this harmonic will be detected. Signals at the original reference frequency are not detected and are attenuated as if they were noise. Always check the harmonic detect number before making any measurements.

The Sine Out is not affected by the harmonic detection. Its frequency is always the fundamental reference frequency.

Internal and Chop Reference

When the reference mode is Internal or Chop, these keys change the internal harmonic number N_{int} and detection is at $N_{\text{int}} \times f_{\text{int}}$ and the internal reference frequency is limited to 500 kHz/ N_{int} .

External Reference

When the reference mode is External, these keys change the external harmonic number N_{ext} and detection is at $N_{\text{ext}} \times f_{\text{ext}}$. The SR860 will always track the external reference.

Dual Reference

When the reference mode is Dual, detection is at $f_{\text{dual}} = |N_{\text{int}} \times f_{\text{int}} - N_{\text{ext}} \times f_{\text{ext}}|$. Use the harmonic numeric entry screen to adjust either harmonic number. The limits described above apply. The Sine Out will still be at f_{int} .

<Amplitude>

This knob adjusts the sine out amplitude.

The amplitude is shown in the info bar at the top of the screen. Touch the {Ampl} tile to show the numeric entry screen.

The amplitude has 3 digits or 1 nV resolution, whichever is larger. The amplitude can range from 1 nV_{rms} to 2.00 V_{rms}.

Press and hold this knob to set the amplitude to zero.

The Sine Out amplitude is specified for differential output (Sine+) – (Sine–). Each output BNC has the specified rms amplitude through a 50Ω output impedance. If an output is

terminated in a high impedance, the amplitude will be the specified value. If an output is terminated in 50Ω , the amplitude will be half the specified value. The outputs are 180° out of phase. If both outputs are used differentially, the amplitude will be twice the output of a single BNC.

In general, if single output is used as the A input, the measured signal will be the specified amplitude (a single output terminated in a high impedance).

Using differential signals can be helpful when the sine amplitude is very small.

When the reference source is Internal or Dual, this is the excitation source provided by the SR860. When an external reference is used (or in Chop mode), this sine output provides a sine wave phase locked to the external reference.

The rear panel BlazeX BNC output can be configured in the System menu (hold [Calc/system]) to provide a square wave sync at the reference frequency. This square wave is generated by discriminating the zero crossings of the sine output. This signal can provide a trigger or sync signal to the experiment when the internal reference source is used. This signal is also available when the reference is externally provided. In this case, the sync output is phase locked to the external reference.

<DC Level>

This knob adjusts the sine out dc level.

The dc level is shown in the info bar at the top of the screen. Touch the {DC} tile to show the numeric entry screen.

The dc level has 3 digits or 0.1 mV resolution, whichever is larger. The dc level ranges from -5.00 V to $+5.00$ V.

Press and hold this knob to set the dc level to zero.

The dc level adds an offset to the sine output. Each output BNC has the specified dc level through a 50Ω output impedance. If an output is terminated in a high impedance, the dc level will be the specified value. If an output is terminated in 50Ω , the dc level will be half the specified value.

The dc level is added to the outputs in Difference mode (opposite sign dc level on each BNC) or in Common mode (same sign dc level on both BNC's). Choose the mode with the [Mode] key.

DC Level [Mode]

This key selects the dc level mode. The dc level is added to the sine outputs in Difference mode (opposite sign dc level on each BNC) or in Common mode (same sign dc level on both BNC's).

Display

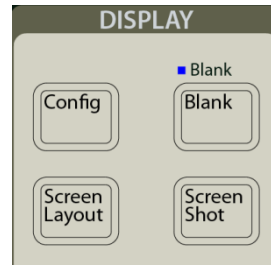

[Screen Layout]

Press [Screen Layout] to cycle through the different screen layouts.

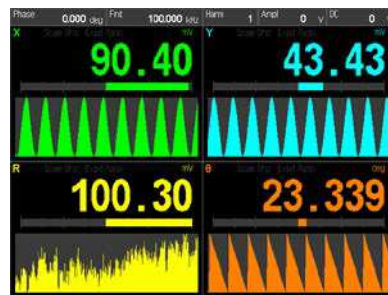

Trend Graph



Full Screen Strip Chart



Half Screen Strip Chart



Full Screen FFT



Half Screen FFT



Big Numbers

[Screen Shot]

Pressing [Screen Shot] saves a screen shot to the USB memory stick as a .BMP file. Set the Print Mode in the system menu. Screen is an exact screen shot, Print replaces the

black background with white and Monochrome is black and white. Screen shots also contain the time/date and summary of input parameters.

The **Busy** LED indicates that the USB stick is busy and should not be removed.

[Blank]

Press the [Blank] key to operate with the front panel display and LEDs off. The SR860 is still operating, the outputs are active, data collection continues and the unit responds to interface commands. To change a setting, press [Blank] to return to normal operation, change the desired parameter, then press [Blank] again.

The **Blank** LED is lit while the rest of the display is off.

[Config]

The SR860 displays up to 4 channels at a time, in green, blue, yellow and orange. Each channel is assigned a parameter using the [Config] key. Parameters are chosen from X, Y, R, θ (detected), F_{int} , F_{ext} , Reference Phase, Sine Amplitude, DC Level, any Aux Input or Output, Xnoise, or Ynoise .

Highlight one of the channel's Display tile, then select a parameter from below to assign it to the channel.

Displayed parameters can be re-assigned at any time. Data is being stored for all parameters all of the time.



Cursor

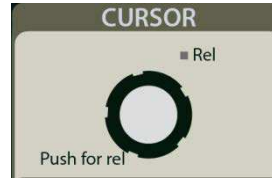

<Cursor>

The screen cursor readout is only available for strip chart and FFT displays. Trend and Big Number screens do not have a cursor function.

Strip Chart Cursor

The strip chart cursor is only active when the strip chart is paused and the graph is stationary. Use {Pause} in the horizontal scale palette to stop the chart scrolling and pause the graph. Use the <Cursor> knob to position the display cursor and readout the data values. These readouts correspond to the min, max or mean of the data in the time bin at the cursor location. The time of the cursor location is displayed in the tile at the left edge of the scale bar below the graph. Touch this tile to switch between elapsed time from the right edge to absolute time (time and date when the point was taken). Use {Cursor MinMaxMean} and {Cursor Width}, on the horizontal scale palate, to change the cursor. Note that the cursor marker may not lie on the data graph for wide cursors since the marker shows the min, max or mean of all the data within the cursor width.

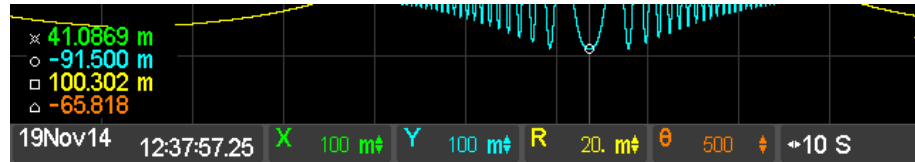

Relative Chart Cursor

To read chart data relative to a reference point within the chart, position the cursor at the desired reference location and press the <Cursor> knob once. A stationary vertical line is placed at the reference location and the cursor readout values will be relative to the data at this location, and the **Rel** LED is lit. Touch the cursor location tile (below the cursor readouts) to switch between absolute time and time relative to the cursor.

Note that changing the horizontal scale may move the reference location off screen (to the left). The reference location is preserved in this case, the reference line is just not visible on the graph.

To clear the reference location, press the <Cursor> knob again. The cursor readout now toggles between absolute time and elapsed time from the right hand edge, and the **Rel** LED turns off.

FFT Cursor

The cursor is always active in the FFT screens. The amplitude and frequency readout is at the upper right of the graph. Use the <Cursor> knob to position the cursor. There is no relative cursor function

Touch  in the vertical scale palette to change the width of the cursor. In the FFT display, the wide cursors always find the peak within the cursor region. This makes reading an FFT much easier.

Functions

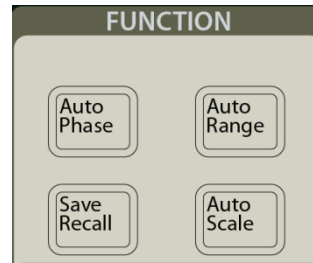

[Auto Phase]

[Auto Phase] adjusts the reference phase shift so that the measured signal phase is 0° . This is done by subtracting the measured value of θ from the reference phase shift. It will take several time constants for the outputs to reach their new values during which time θ will move towards 0° . Do not press [Auto Phase] again until the outputs have stabilized. When the measurement is noisy or if the outputs are changing, Auto Phase may not result in a zero phase.

[Auto Range]

[Auto Range] will adjust the Input Range so that the input signal does not overload the input amplifier and that there is sufficient gain to drive the A/D converter. Remember that the signal input is both the signal at f_{ref} plus noise which may be much larger. The largest component of the signal will determine the resulting input range.

When the input is at very low frequency, [Auto Range] may not function well. In this case it is better to watch the signal strength indicators and change the input range manually.

[Auto Scale]

[Auto Scale] will adjust the Sensitivity so that the displays and outputs of X, Y and R are optimized. This results in numeric and bar graph displays with the best resolution possible.

Note that the Sensitivity will affect analog outputs proportional to X, Y and R. Do not use [Auto Scale] if changes to the analog output scales cannot be tolerated in the experiment.

[Save Recall]

Press [Save Recall] to display the Save/Recall screen.

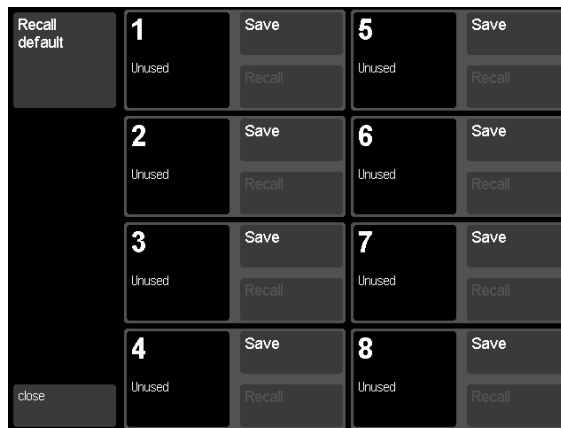

The SR860 can store 8 complete setups. In addition the default setup can be recalled.

Touch one of the 8 {Save} buttons to save a setup. Enter a name for this setup using the keypad. Touch {Confirm} to commit the current setup or {Cancel} to quit the operation.

Locations which already contain a saved setup will show the setup name and the time and date it was saved.

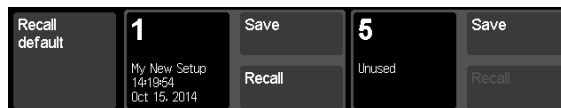

Touch {Recall} for a location with a previously saved setup and a summary of settings which will change upon recall is shown.

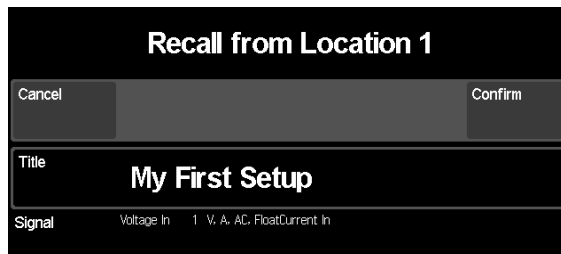

Touch {Cancel} to skip recalling this setup or touch {Confirm} to recall the setup and dismiss this screen.

Interface and Data

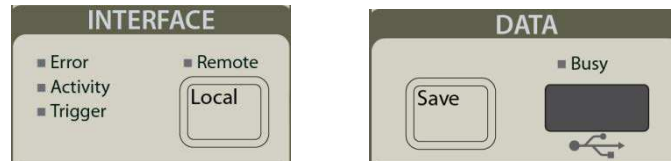

Error

The **Error** indicator flashes whenever there is a computer interface error such as an illegal command or out of range parameter is received.

Activity

The **Activity** indicator flashes when there is command activity on a computer interface.

Trigger

The **Trigger** indicator flashes for triggered data acquisition.

Remote

The **Remote** indicator is on when the front panel is locked out by a computer interface. No front panel adjustments may be made.

[Local]

When a host computer places the unit in the REMOTE state, the keys, knobs and touchscreen are locked out. The **Remote** indicator is on above the [Local] key. To return to front panel operation, press the [Local] key.

Press and hold [Local] while turning the power on to reset the unit to its default settings. This does not affect the computer interface settings.

[Save]

The SR860 can save data files to a USB memory stick inserted into the front panel USB slot.

Press [Save] to save the data points in the current strip chart to the memory stick. This file can be .CSV or .MAT file as selected in the system menu.

The **Busy** LED indicates that the USB stick is busy and should not be removed.

Setup

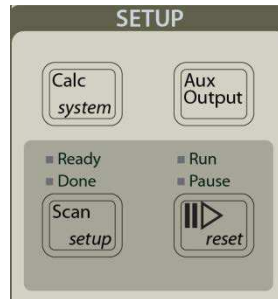

[Scan/setup] and [Play/Pause]

Press and hold [Scan/setup] to display the scan setup screen.

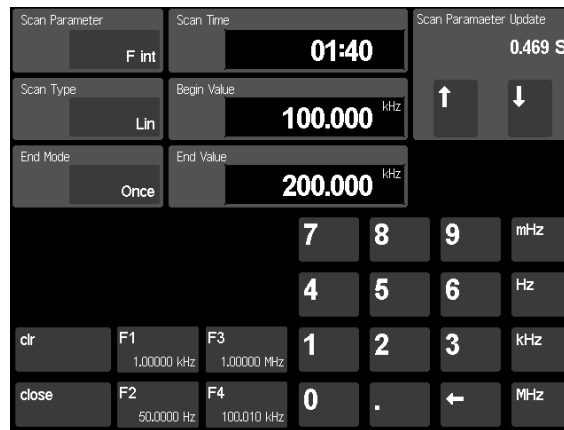

The Scan Parameter can be F_{internal} , Sine Amplitude, Sine DC Level, Aux Out 1 or Aux Out 2.

The Scan Type can be Linear or Logarithmic.

The Begin and End Values are the start and stop values for the scanned parameter.

The Scan Time is the total time to move from the Begin Value to the End Value. The Scan Parameter Update is the time spent at each scan step along the way. The shorter the time, the more steps in the scan and the smoother the parameter varies. The longer the time, the fewer steps. With experiments that take time to settle after a parameter change, it is often beneficial to set the update time long enough to accommodate the settling.

The scan End Mode can be Repeat, repeat Up/Down or Once (pause at the end). When the End Mode is set to repeat, the scan repeats over and over. Often when scanning, it is convenient to pause the strip chart at the end of the scan to review the results. Set the End Mode to Once, and the scan stops at the end value and the strip chart is automatically paused.

To Run a Scan

Press [Scan/setup] briefly (don't hold it) to turn on the scan to ready. This key turns scanning on and off.

The **Ready** LED turns on indicating that the scan is ready (at the begin value). At this time, the scanning parameter (if it is being displayed on screen) is shown in orange indicating that it is under scan control.

Press [Play Pause/reset] briefly to start the scan.

The **Run** LED turns on indicating that the scan is running. The scanning parameter starts from its begin value to its end value. Press [Play Pause/reset] briefly to pause and resume the scan. The **Pause** LED turns on indicating a scan is paused.

When the End Mode is set to Repeat or Up/Down, the scan repeats over and over.

When the End Mode is Once, the scan stops at the end value, the strip chart is paused and the **Done** LED turns on. Note that data collection continues while the chart is paused. Restarting the chart realigns the time history so the current time is the right edge again.

Press and hold [Play Pause/reset] to reset the scan back to the Begin Value. This leaves the **Ready** LED on and turns the **Done** LED off.

Press [Play Pause/reset] briefly to start the scan again.

To Stop Scanning

Press [Scan/setup] briefly (don't hold it) to turn off the scan. This key turns scanning on and off. The [Play Pause/reset] has no effect unless scanning is on and the **Ready** LED is lit.

Turning the scan off reverts the scanned parameter back to its original value (from before scanning) and its display back to white (under front panel control).

Changes to Scan Parameters

Once the scan is turned on to ready by briefly pressing [Scan/setup], the scan configuration is loaded into the scanning system for use. Edits to scan parameters, such as Scan Time, End Mode, etc., can be entered from the scan setup screen but will not affect the current scan. To put any changes into action, [Scan/setup] must be briefly pressed to turn off the **Ready** LED, and then briefly pressed again to re-enable scans and turn the **Ready** LED back on. Alternatively, press and hold [Play Pause/reset] to return to the **Ready** LED on state; this will also put newly changed scan parameters into effect.

[Aux Output]

Press [Aux Output] to display the Aux Output screen.

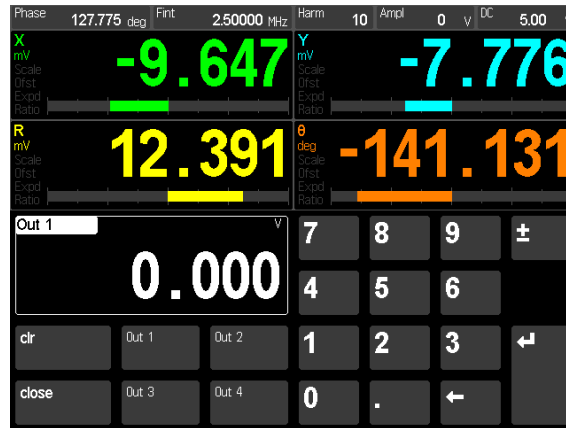

The SR860 has 4 Aux Outputs on the rear panel. Use this screen to set their levels.

Touch one of the {Out n } buttons to select an aux output, then use the keypad to enter a value. The <Cursor> knob will also adjust the output value in this screen.

[Calc/system]

Press [Calc/system] briefly to display the calculator screen.

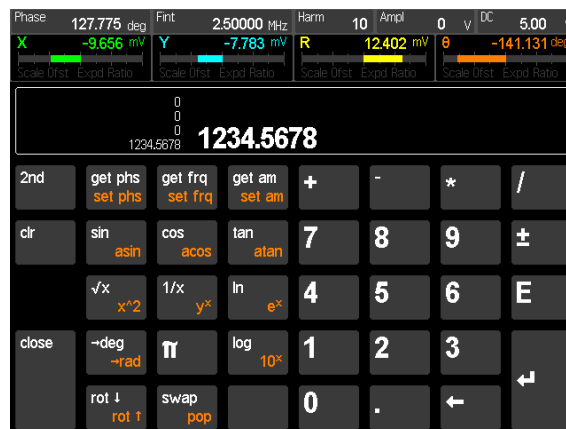

This is an RPN calculator where the operator follows all of its operands. For more information, ask your friends or check the internet.

The {2nd} button switches the functions of the operator keys.

Note that the reference phase, frequency and amplitude can be copied in and out of the calculator.

System Menu

Press and hold [Calc/system] to display the system menu. The system menu is used to set non-measurement parameters such as computer interface configurations, file names, clock setup and more. Use the {↑} and {↓} buttons next to the category list to move up and down through the category list (General – Files – Ethernet ...). Touch a {category} to show its settings.

To change a setting, touch the setting (shown within a dark gray tile) to either toggle the selection or highlight it for keypad entry. The Enter {↵} button advances to the next entry tile in a section. For more information about using the computer interfaces see the Remote Programming chapter.

General Settings

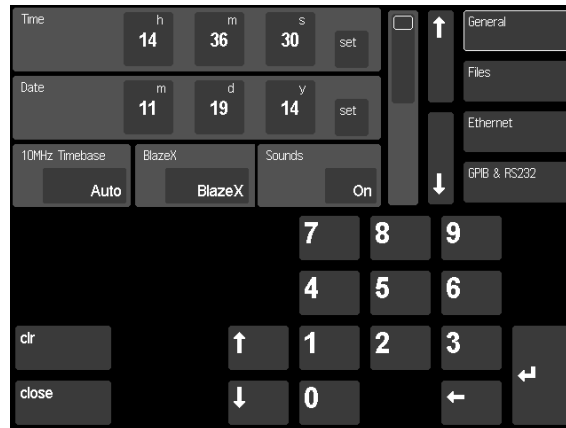

Time and Date

Touch the {h} button in the Time section to highlight the hours setting. Use the keypad or {↑} and {↓} buttons to set the hour of day in 24 hour format. The time will highlight in orange indicating that the display is not the current time but rather the time that will be set. Continue to enter the minutes and seconds then touch {set} to commit the time to the internal clock. Repeat this process for the date.

The time and date are used to label data files and screen shots as well as saved settings.

10MHz Timebase

The SR860 can accept an external 10 MHz timebase input on the rear panel. This allows the internal reference frequency of the SR860 to remain frequency and phase stable with other SR860 units on the same timebase.

When set to Internal the external timebase input is ignored. When set to Auto, the SR860 will automatically lock to an external timebase whenever a 1 Vrms 10 MHz signal is detected at the timebase input. If the external timebase signal drifts out of range (either in amplitude or frequency) this setting will revert to Internal.

The **Ext 10 MHz** LED is on when the unit is locked to an external timebase.

The SR860 can also output its own 10 MHz timebase to another unit.

Sounds

Sounds can be toggled from On to Mute. These are primarily the key and knob clicks but also includes various other notification sounds.

Sync/BlazeX

The rear panel BlazeX output BNC can be configured to output a reference frequency sync signal (either bipolar or unipolar square sync) or a low-latency X output (for closed loop applications at short time constants).

File Settings



Data and screenshots can be saved to a USB memory stick inserted into the front panel. Press the [Save] button to save all the data values currently plotted on the strip chart. Press the [Screen Shot] button to save an image of the screen. The memory stick must be formatted as FAT32, and the saved files can be read by Windows and Macintosh computers.

Folder

Navigate to the destination folder on the memory stick. New files will be saved in the destination folder.

The subdirectories in the current destination folder are listed. Use the {↑} and {↓} buttons in this section to scroll the list of subdirectories. Touch a {subdirectory} to select it as the destination. Touch {...} to go up one directory level. Repeat until the desired directory is selected.

Prefix and Suffix

File names are generated from the Prefix string and the Suffix number. The Next File Name is shown. The suffix number is automatically incremented after every file save. The extension is .BMP for screenshots and either .CSV or .MAT for data files.

File names must conform to the 8.3 format so the length of Prefix plus the length of the Suffix is limited to an 8 character string.

Enter an alphanumeric prefix string and a numeric suffix.

Print Mode

Pressing [Screen Shot] saves a screen shot to the memory stick as a .BMP file. Set the Print Mode to Screen, Print or Monochrome. Screen is an exact screen shot, Print replaces the black background with white and Monochrome is black and white.

Format

Determines the format of the data files that are produced when the [Save] button is pressed. Has no effect on screenshots. Format can be set to .CSV (comma-delimited ASCII text file) or .MAT (Matlab binary file).

Ethernet Settings



Choose either Static or DHCP for the TCP/IP address mode. Highlight an address value to change it using the numeric keypad.

GPIB and RS-232 Settings



Highlight the GPIB Address to change it using the numeric keypad.

Use the RS-232 Baud Rate {↑} and {↓} buttons to select a baud rate. Select a terminator and parity.

VXI-11 and Web Settings

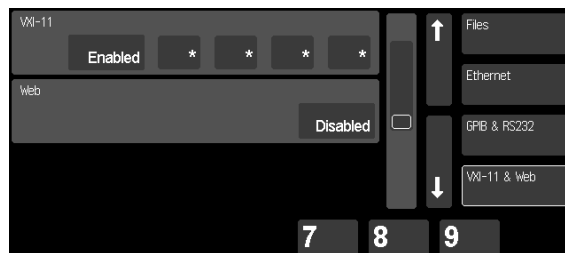

The SR860 allows computers to connect via VXI-11 from a range of Trusted IP addresses or Disabled altogether.

Set the Trusted IP address using ‘*’ as a wildcard. This allows any computer on a specified subnet VXI-11 access.

The SR860 has a webserver which allows computer access thru a webpage (at the SR860’s IP address). This access can be Enabled or Disabled. The webserver allows instrument settings to be changed and the outputs to be monitored.

Telnet Settings

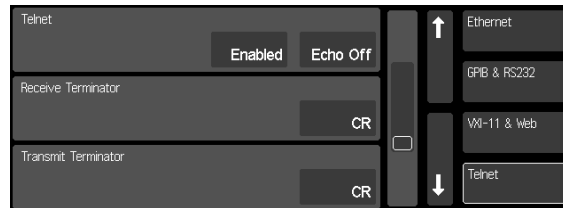

The SR860 supports telnet connections. This can be Enabled or Disabled.

Choose Echo On/Off and the Receive/Transmit Terminators depending upon your host software requirements.

Streaming Settings



The SR860 can stream output values continuously over the ethernet interface to a host computer. It is the host computer's responsibility to keep up, there is no retry on dropped packets.

Select the output {Channels} (X), (X and Y), (R and θ) or (X, Y, R and θ) and the desired {Format} 32 bit Float or 16 bit Integer. Integers are scaled to the sensitivity.

The number of bits per sample point can range from 16 (X, integer) to 128 (XYR θ , float). This has an impact on the network bandwidth necessary to maintain the stream.

The Sample Rate can be set to a fixed rate (1.25 MHz down to sub-millihertz). The total bandwidth required is the sample rate times the number of bits per point. Note that Sample Rate can change in response to changing the signal Time Constant. The Sync filter, when engaged, can also modify the Sample Rate based on the signal frequency.

Choose the Packet Size to work with your host software.

The host Status is displayed.

Update Firmware

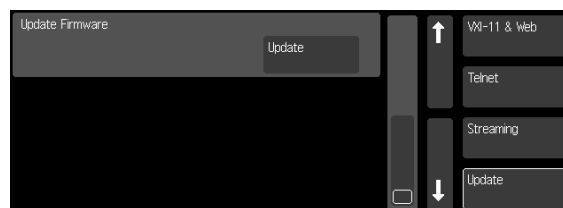

The SR860's firmware can be updated via the USB memory stick. Follow the directions that accompany the update to prepare the memory stick. Insert the memory stick into the front panel and press {Update} to start the process.

Rear Panel



Power Entry Module

The power entry module is used to fuse the ac line voltage input, select the line voltage, and block high frequency noise from entering or exiting the instrument. Refer to the first page of this manual for instructions on selecting the correct line voltage and fuse.

GPIB Port

The 24 pin GPIB (IEEE-488) port allows a computer to control the SR860 via the IEEE-488 instrument bus. The address of the instrument is set in the system menu (hold the [Calc/system] key).

RS-232 Port

The RS-232 interface port is configured as a DCE. The baud rate and parity are set in the system menu (hold the [Calc/system] key). The number of data bits is always 8.

USB Port

The USB port allows a computer to control the SR860 via USB. The SR860 is a Test and Measurement Class instrument.

Ethernet Port

The Ethernet port allows a computer to control the SR860 via an ethernet network connection. In addition, the SR860 can serve web pages to the network and stream data over the network. The network addresses and permissions are configured in the system menu (hold the [Calc/system] key).

The green LED indicates that the unit is connected. The yellow LED is on for a gigabit connection and off for a 10/100 connection.

Timebase In/Out

Apply a 10 MHz sine signal (1 Vrms) to the TIMEBASE input to lock the SR860's timebase to an external timebase. The internal reference frequency of the SR860 is derived from this timebase. When multiple SR860's are locked to the same 10 MHz timebase, then harmonically related internal frequencies on different units will stay in phase indefinitely.

The **Ext 10 MHz LED** is on when the unit is locked to an external timebase.

The SR860 also outputs its own 10 MHz timebase (to another unit).

Note that external function generators, even a direct digital synthesizer locked to the same 10 MHz timebase, will not stay in phase with the SR860. This is because the resolution of the frequency tuning word in the external direct digital synthesizer differs from the SR860.

HDMI Output

Use the HDMI output to display the SR860 screen on a large computer monitor or television. The output has a resolution of 640×480 and a frame rate of 60 Hz.

Aux In 1–4

These are auxiliary analog inputs which can be digitized by the SR860. The range is ± 10.5 V, the resolution is 1 mV and the inputs are 1 M Ω . These inputs can be displayed on the screen, read over the computer interfaces and graphed on the strip charts.

Aux Out 1–4

These are auxiliary analog outputs. The range is ± 10.5 V and the resolution is 1 mV. These outputs may be programmed from the front panel (via [Aux Output]), scanned (via [Scan/setup]) or controlled via the computer interfaces. Aux Out 4 is used to control an SR540 chopper when the reference mode is Chop.

X and Y Outputs

The X and Y lock-in outputs are always available at these connectors. Although the demodulator output values are generated at a (time constant dependent) rate up to 1.25 MHz, the X and Y output hardware is always upsampled to an output update rate of 2.222 MHz. An input signal equal to the sensitivity will generate ± 10 V at these outputs.

These outputs are identical to the front panel CH1 and CH2 outputs when set to X and Y. These outputs are affected by the sensitivity and the X and Y offsets and expands.

Signal Monitor Output

This BNC provides a buffered output from the signal amplifier. This is the signal just before the anti-aliasing filter, A/D converter and PSD. The amplifier gain is determined by the Input Range (voltage input) or the Current Range (current input). The output is about 1 V for a maximum input.

This output is useful for determining the cause of input overloads, not necessarily for viewing the signal of interest. If the f_{ref} signal is small relative to the input range, it may not be amplified enough to be viewed at the monitor output.

Trig Input

This TTL input is used to start data capture to the internal buffer. This buffer is only accessible via the computer interface. The remote interface sets the capture start mode to triggered. The Trig Input then starts data capture into the data buffer. The internal buffer is 32 MB and can be configured to record (X), (X and Y), (R and θ), or (X, Y, R and θ) at various sample rates up to 1.25 MHz.

See the Remote Programming section for more information.

Sync/BlazeX Output

This output can be either the reference Sync output or the BlazeX output as configured in the system menu (hold the [Calc/system] key).

Sync

The Sync output is a $\pm 2V$ or a 0-2V square wave whose edges are linked to the sine output zero crossings. This is useful when the sine output amplitude is small and a synchronous trigger is required (to a scope for example). This output is active even when the SR860 is locked to an external reference.

BlazeX

The BlazeX output is a $\pm 2V$, low latency version of the X output. It's intended for experiments that require the fastest possible output response, such as feedback loops that employ the SR860 within the loop. The BlazeX output is always an RC filter (1 to 4 poles) regardless of the front panel Advanced Filter setting, and its maximum time constant is 10 ms. If a longer time constant is required, the normal X output should be used instead.

The BlazeX output is modified by offset and expand, *but is not affected by the ratio function.*

Preamp Connector

This 9 pin connector provides power to external preamplifiers such as the SR550, SR551, or SR552. The power connections are described below.

<u>Pin</u>	<u>Voltage</u>	
1	+18.5 V	(up to 100 mA)
2	+5 V	(up to 100 mA)
6	-18.5 V	(up to 100 mA)
7	Signal Ground	
8	Ground	

Using SRS Preamps

When using an SRS preamp, connect the power cable (standard male-to-male 9 pin D connectors) from the preamp to the rear panel preamp connector on the SR860. Use BNC

cables to connect the A output from the preamp to the A input of the SR860 and the B output from the preamp (preamp ground) to the B input of the SR860. Use A-B as the input configuration. Be sure to twist the A and B cables so that there is no differential noise pickup between the cables.

The signal coupling and input impedance is now determined by the preamp.

The SR860 does NOT compensate for the gain of the preamp. The preamps will default to their maximum gain. Measurements made by the SR860 with a preamp need to be divided by the gain of the preamp.

Chapter 4

Programming

Introduction

The SR860 DSP Lock-in Amplifier may be remotely programmed via the RS-232, GPIB (IEEE-488), USB or ethernet interfaces. Any computer supporting one of these interfaces may be used to program the SR860. All interfaces can receive commands at all times and the SR860 will send responses to the querying interface only. A few specialized commands such as interface status and data streaming are interface specific. Most instrument commands are common to all interfaces.

Communicating With GPIB

The SR860 supports the IEEE-488.2 (2004) interface standard. The SR860's device address must be set in the system menu (hold [Calc/system]).

Communicating With RS-232

The RS-232 interface baud rate and parity must be set in the system menu (hold [Calc/system]). The RS-232 word length is always 8 bits. The transmit terminator character(s) may also be specified.

Communicating With USB

The SR860 is a Test and Measurement Class instrument and easily interfaces with LabVIEW, NI-VISA and Matlab.

Communicating With Ethernet

The SR860 supports VXI-11 and telnet and interfaces easily with LabVIEW, NI-VISA and Matlab. In addition, SR860 has a built in webserver. Data streaming over ethernet is also supported.

Before attempting to communicate with the SR860 over the ethernet interface, the instrument IP address must be set in the system menu (hold [Calc/system]). Additional settings for ethernet operation must also be set.

Status Indicators

To assist in programming, the SR860 has 3 interface status indicators. The **Activity** indicator flashes whenever any interface is actively sending or receiving. The **Error** indicator flashes when an error, such as an illegal command, or parameter out of range, is detected. The **Remote** indicator is on whenever the SR860 is in a remote state (front panel locked out).

GPIB Interface Ready And Status

The Interface Ready bit (bit 1) in the Serial Poll Status Byte signals that the SR860 is ready to receive and execute a command. When a command is received, this bit is cleared indicating that an operation is in progress. While the operation is in progress, no other commands will be received. Only GPIB serial polling will generate a response while a command is in progress. When the command execution terminates, the Interface Ready bit is set again and new commands can be received. Since most commands execute very quickly, the host computer does not need to continually check the Interface Ready bit.

When using the GPIB interface, serial polling may be used to check the Interface Ready bit in the Serial Poll Byte while an operation is in progress. After the Interface Ready bit becomes set, signaling the completion of the command, then the ERR or ESB bit may be checked to verify successful completion of the command.

If an interface other than GPIB is used, then serial polling is not available. The *STB?, *ESR?, ERRS?, and LIAS? status query commands may be used to query the Status Bytes. Since the SR860 processes one command at a time, the status query will not be processed until the previous operation is finished. Thus a response to the status query in itself signals that the previous command is finished. The query response may then be checked for various errors.

Command Syntax

A command to the SR860 consists of a command mnemonic, a space followed by arguments if necessary, and a command terminator. **There MUST be at least one space between the command and the first argument.** Multiple arguments are separated by commas. Some commands have no arguments. The command terminator must be a linefeed <lf> on RS-232, or a linefeed <lf> or EOI on GPIB. No command processing occurs until a command terminator is received.

Commands function identically on all interfaces whenever possible. Command mnemonics beginning with an asterisk '*' are IEEE-488.2 defined common commands. These commands also function identically on the other interfaces.

Multiple commands may be sent on one command line by separating them with semicolons (;).

The present value of a particular parameter may be determined by querying the SR860 for its value. A query is formed by appending a question mark '?' to the command mnemonic and omitting the desired parameter(s) from the command. No space is allowed between the command and the '?'. Values returned by the SR860 are sent as a string of ASCII characters. If multiple queries are sent on one command line (separated by semicolons, of course) the responses will be returned as semicolon-separated strings.

Command Conventions

Commands and arguments may be in either UPPER or lower case.

Arguments shown in { } are optional or may be queried.

Arguments in [] are required.

A list of allowable enumerated values is shown as **A | B | C**. The argument can be either A or B or C.

Commands that may be queried have a question mark in parentheses (?) after the mnemonic. Commands that may ONLY be queried have a ? after the mnemonic, without parentheses. NO SPACE is allowed between the mnemonic and the ?. Commands that MAY NOT be queried have no ?.

Do NOT send () or { } or [] or | as part of the command. A space is required between a command and its arguments.

Variables

i, j, k, l, m, n	integers
x	real number
f	frequency (real number)
p	phase (real number)
v	voltage (real number)
s	"string"

Integer variables must be expressed in integer format (no decimal point or exponent).

Real number variables may be expressed in integer, floating point or exponential formats (i.e., the number five can be either 5, 5.0, or .5E1).

Strings are a sequence of ASCII characters within quotes (“...”).

Units

For numerical values of frequency, phase or volts, a units string may be appended to a set command. If the unit string is omitted then the value is assumed to be the base unit, either Hz, degrees or Volts. The accepted unit strings are:

“NV”	nanoVolts	“HZ”	Hertz	“UDEG”	microDegrees
“UV”	microVolts	“KHZ”	kiloHertz	“MDEG”	milliDegrees
“MV”	milliVolts	“MHZ”	megaHertz	“DEG”	Degrees
“V”	Volts				

For example, the following commands to set the internal frequency are all equivalent

```
FREQ 1234.56
FREQ 1234.56 HZ
FREQ 1.23456 KHZ
```

Queries of f, p or v always return the value in the base units of Hz, degrees or Volts.

Enumerated Strings

Many commands have an enumerated list of allowed settings. It is possible to specify the setting with a string instead of the integer index. Using the enumeration strings improves the readability of your source code.

Enumerated strings can either be the substring shown in CAPS or the full string. For example, the enumeration string “ABCDefgh” can be sent as ‘abcd’ or ‘abcdefgh’. The string can be sent with any capitalization.

For example, the IVMD i command sets the input to either voltage (i=0) or current (i=1). This command is specified as

```
IVMD(?) { VOLTage | CURRent | i }
```

The following commands are all equivalent ways to set the input to voltage.

```
IVMD 0
IVMD VOLT
IVMD VOLTAGE
```

These commands are all equivalent ways to set the input to current.

```
IVMD 1
IVMD CURR
IVMD CURRENT
```

The IVMD? query always returns the setting index i (0 or 1 in this case).

Example Commands

RSRC 1 RSRC EXT	Set reference source to external
RSRC ?	Query the reference source
FREQ 10E3 FREQ 10 KHZ FREQ 10000.0	Set the internal reference frequency to 10000 Hz
APHS	Execute Auto Phase

Reference Commands

TBMODE(?) { AUTO | INTERNAL | i }

The TBMODE i command sets the external 10 MHz timebase mode to auto (i=0) or internal (i=1).

Example

TBMODE AUTO Set the timebase mode to auto
TBMODE 0

TBMODE? Returns the timebase mode i

TBSTAT?

The TBSTAT? query returns the current 10 MHz timebase source, either external (0) or internal (1).

Example

TBSTAT? Returns the current 10 MHz timebase

PHAS(?) { p } { UDEG | MDEG | DEG | URAD | MRAD | RAD }

The PHAS p command sets the reference phase shift to p degrees. The value of p is set with a resolution of $\sim 0.0000001^\circ$. The phase may be programmed from $-360000^\circ \leq p \leq 360000^\circ$ and will be wrapped around at $\pm 180^\circ$. For example, the PHAS 541.0 command will set the phase to -179.00° ($541-360 = 181$; $181-360 = -179$). Phase may be specified in degrees (default), or millidegrees, microdegrees, radians, milliradians, or microradians.

Example

PHAS 12.34 DEG Set the reference phase to 12.34 deg
PHAS 1.234E1
PHAS 12340 MDEG

PHAS? Returns the reference phase in degrees

APHS

The APHS command performs the Auto Phase function. This command is the same as pressing the [Auto Phase] key. The outputs will take many time constants to reach their new values. Do not send the command again without waiting the appropriate amount of time.

FREQ(?) { f } { HZ | KHZ | MHZ }

The FREQ f command sets the internal frequency to f. The value of f will be rounded to 6 digits or 0.1 mHz, whichever is greater. The value of f is limited to $1 \text{ mHz} \leq f \leq 500 \text{ kHz}$.

The query form, FREQ?, returns the internal reference frequency whenever the reference mode is either Internal, Dual, or Chop. The query returns the external frequency when operating in External mode. This behavior mirrors the value displayed in the info bar at the top of the display.

Example

FREQ 12.34E3 Set the internal frequency to 12.34 kHz
 FREQ 12.34 KHZ
 FREQ 12340

FREQ? Returns the internal (or external) frequency in Hz

FREQINT(?) { f } { HZ | KHZ | MHZ }

The FREQINT f command sets the internal frequency to f. The value of f will be rounded to 6 digits or 0.1 mHz, whichever is greater. The value of f is limited to $1 \text{ mHz} \leq f \leq 500 \text{ kHz}$.

The query form, FREQINT?, always returns the internal reference frequency.

Example

FREQINT 12.34E3 Set the internal frequency to 12.34 kHz
 FREQINT 12.34 KHZ
 FREQINT 12340

FREQINT? Returns the internal frequency in Hz

FREQEXT?

The FREQEXT? query returns the external reference frequency.

Example

FREQEXT? Returns the external frequency in Hz

FREQDET?

The FREQDET? query returns the actual detection frequency. This is helpful in dual reference mode or harmonic detection. Otherwise, the detection frequency is either the internal or external reference frequency.

Example

FREQDET? Returns the detection frequency in Hz

HARM(?) { i }

The HARM i command will set the lock-in to detect at the i^{th} harmonic of the reference frequency. The value of i is limited to $1 \leq i \leq 99$.

Example

HARM 2 Set the harmonic detect to 2

HARM? Returns the harmonic number i

HARMDUAL(?) { i }

The HARMDUAL i command will set the lock-in to detect at the i^{th} harmonic of the external frequency in dual reference mode. The value of i is limited to $1 \leq i \leq 99$. The actual detection frequency, when operating in dual reference mode, is

$$f_{\text{detect}} = |i_{\text{HARM}} \times f_{\text{int}} - i_{\text{HARMDUAL}} \times f_{\text{ext}}|$$

Example

HARMDUAL 2 Set the dual external harmonic detect to 2

HARMDUAL? Returns the dual external harmonic number i

BLADESLOTS(?) {SLT6 | SLT30 | i }

The BLADESLOTS i command configures the lock-in for operation with an external SR540 chopper. Before proper operation in RSRC EXT mode, the SR860 must be configured for either 6-slot (i=0) or 30-slot (i=1) operation, based on the hardware installed on the SR540 chopper. You can read more about operation in chop mode on page 76.

Example

BLADESLOTS SLT30 Configure for 30-slot chopper blade
BLADESLOTS 1

BLADESLOTS? Returns chopper blade configuration

BLADEPHASE(?) { p } { UDEG | MDEG | DEG | URAD | MRAD | RAD }

The BLADEPHASE p command sets the phase of the SR540 chopper blade. When operating a single chopper, this has little effect since the SR860 will follow the chopper. If multiple SR860/SR540 systems are being used in a single experiment, BLADEPHASE can be used to modify the relative phase of the choppers. Blade phase may be specified in degrees (default), or millidegrees, microdegrees, radians, milliradians, or microradians. You can read more about chopper blade phase on page 77.

Example

BLADEPHASE 43.21 DEG Set the blade phase to 43.21 deg
BLADESLOTS 4.321E1

BLADEPHASE? Returns chopper blade phase

SLVL(?) { v } { NV | UV | MV | V }

The SLVL v command sets the sine out amplitude to v. The value of v will be rounded to 3 digits or 1 nV, whichever is greater. The amplitude may be programmed from 1 nV to 2.0 V.

Example

SLVL 12.3 MV Set the sine out amplitude to 12.34 mV
SLVL 1.23E-2
SLVL 0.0123

SLVL? Returns the sine out amplitude in Volts

SOFF(?) { v } { NV | UV | MV | V }

The SOFF v command sets the sine out dc level to v. The value of v will be rounded to 3 digits or 0.1 mV, whichever is greater. The level may be programmed from -5.00 V to +5.00 V.

Example
 SOFF 34.5 MV Set the sine out dc level to 34.5 mV
 SOFF 3.45E-2
 SOFF 0.0345

SOFF? Returns the sine out dc level in Volts

REFM(?) { COMmon | DIFference | i }

The REFM i command sets the sine out dc mode to common (i=0) or difference (i=1).

Example
 REFM DIF Set the dc mode to difference
 REFM DIFFERENCE
 REFM 1

REFM? Returns the dc mode i

RSRC(?) { INT | EXT | DUAL | CHOP | i }

The RSRC i command sets the reference source to internal (i=0), external (i=1), dual (i=2) or chop (i=3).

Example
 RSRC EXT Set the reference mode to external
 RSRC 1

RSRC? Returns the reference mode i

RTRG(?) { SIN | POSttl | NEGttl | i }

The RTRG i command sets the external reference trigger mode to sine (i=0), positive TTL (i=1) or negative TTL (i=2).

Example
 RTRG POS Set the external reference trigger to positive TTL
 RTRG POSTTL
 RTRG 1

RTRG? Returns the external reference trigger mode i

REFZ(?) { 50ohms | 1Meg | i }

The REFZ i command sets the external reference trigger input to 50 Ω (i=0) or 1 M Ω (i=1).

Example
 REFZ 50 Set the external reference input to 50 Ω
 REFZ 50OHMS
 REFZ 0

REFZ 1M Set the external reference input to 1 M Ω
 REFZ 1MEG

REFZ? Returns the external reference input i

PSTF(?) [j] { , f { HZ | KHZ | MHZ } }

The PSTF j, f command sets a frequency preset to f. These preset buttons are available whenever the internal frequency keypad is displayed. The parameter j (0–3) selects a preset F1–F4. The value of f will be rounded to 6 digits or 0.1 mHz, whichever is greater. The value of f is limited to $1 \text{ mHz} \leq f \leq 500 \text{ kHz}$.

Example

PSTF 1, 12.34 KHZ Set frequency preset F2 to 12.34 kHz
PSTF 1, 12340

PSTF? 1 Returns the frequency preset F2 in Hz

PSTA(?) [j] { , v { NV | UV | MV | V } }

The PSTA j, v command sets a sine out amplitude preset to v. These preset buttons are available whenever the sine out amplitude keypad is displayed. The parameter j (0–3) selects a preset A1–A4. The value of v will be rounded to 3 digits or 1 nV, whichever is greater. The value of v is limited to $1 \text{ nV} \leq v \leq 2.0 \text{ V}$.

Example

PSTA 2, 12.3 MV Set amplitude preset A3 to 12.3 mV
PSTA 2, 0.0123

PSTA? 2 Returns the amplitude preset A3 in Volts

PSTL(?) [j] { , v { NV | UV | MV | V } }

The PSTL j, v command sets a sine out dc level preset to v. These preset buttons are available whenever the sine out dc level keypad is displayed. The parameter j (0–3) selects a preset L1–L4. The value of v will be rounded to 3 digits or 0.1 mV, whichever is greater. The levels may be programmed from -5.00 V to $+5.00 \text{ V}$.

Example

PSTL 0, 1.23 V Set dc level preset L1 to 1.23 V
PSTL 0, 1230 MV

PSTL? 0 Returns the dc level preset L1 in Volts

Signal Commands

IVMD(?) { VOLTage | CURRent | i }

The IVMD i command sets the signal input to voltage (i=0) or current (i=1).

Example

IVMD VOLT	Set the signal input to voltage
IVMD VOLTAGE	
IVMD 0	

IVMD?	Returns the signal input i
-------	----------------------------

ISRC(?) { A | A-B | i }

The ISRC i command sets the voltage input mode to A (i=0) or A-B (i=1).

Example

ISRC A-B	Set the voltage input to A-B
ISRC 1	

ISRC?	Returns the voltage input mode i
-------	----------------------------------

ICPL(?) { AC | DC | i }

The ICPL i command sets the voltage input coupling to ac (i=0) or dc (i=1).

Example

ICPL DC	Set the voltage input coupling to dc
ICPL 1	

ICPL?	Returns the voltage input coupling mode i
-------	---

IGND(?) { FLOat | GROund | i }

The IGND i command sets the voltage input shields to float (i=0) or ground (i=1).

Example

IGND FLO	Set the voltage input shields to float
IGND FLOAT	
IGND 0	

IGND?	Returns the voltage input grounding mode i
-------	--

IRNG(?) { 1Volt | 300Mvolt | 100Mvolt | 30Mvolt | 10Mvolt | i }

The IRNG i command sets the voltage input range to 1 V (i=0), 300 mV (i=1), 100 mV (i=2), 30 mV (i=3) or 10 mV (i=4).

Example

IRNG 1V	Set the voltage input range to 1 V
IRNG 1VOLT	
IRNG 0	

IRNG?	Returns the voltage input range i
-------	-----------------------------------

ICUR(?) { 1MEG | 100MEG | i }

The ICUR i command sets the current input gain to 1 M Ω (1 μ A) (i=0) or 100 M Ω (10 nA) (i=1).

Example

ICUR 100MEG Set the current input gain to 100 M Ω (10 nA)
ICUR 1

ICUR? Returns the current input gain i

ILVL?

The ILVL? query returns the signal strength indicator from lowest (0) to overload (4).

Example

ILVL? Returns the signal strength indication

SCAL(?) { i }

The SCAL i command sets the sensitivity according to the table below.

<u>i</u>	<u>sensitivity</u>	<u>i</u>	<u>sensitivity</u>
0	1 V [μ A]	15	10 μ V [pA]
1	500 mV [nA]	16	5 μ V [pA]
2	200 mV [nA]	17	2 μ V [pA]
3	100 mV [nA]	18	1 μ V [pA]
4	50 mV [nA]	19	500 nV [fA]
5	20 mV [nA]	20	200 nV [fA]
6	10 mV [nA]	21	100 nV [fA]
7	5 mV [nA]	22	50 nV [fA]
8	2 mV [nA]	23	20 nV [fA]
9	1 mV [nA]	24	10 nV [fA]
10	500 μ V [pA]	25	5 nV [fA]
11	200 μ V [pA]	26	2 nV [fA]
12	100 μ V [pA]	27	1 nV [fA]
13	50 μ V [pA]		
14	20 μ V [pA]		

Example

SCAL 6 Set the sensitivity to 10 mV [nA]

SCAL? Returns the sensitivity i

OFLT(?) { i }

The OFLT i command sets the time constant according to the table below.

<u>i</u>	<u>time constant</u>	<u>i</u>	<u>time constant</u>	<u>i</u>	<u>time constant</u>
0	1 μ s	8	10 ms	16	100 s
1	3 μ s	9	30 ms	17	300 s
2	10 μ s	10	100 ms	18	1 ks
3	30 μ s	11	300 ms	19	3 ks
4	100 μ s	12	1 s	20	10 ks
5	300 μ s	13	3 s	21	30 ks
6	1 ms	14	10 s		
7	3 ms	15	30 s		

Example

OFLT 10 Set the time constant to 100 ms

OFLT? Returns the time constant i

OFSL(?) { i }

The OFSL i command sets the filter slope to 6 dB/oct (i=0), 12 dB/oct (i=1), 18 dB/oct (i=2) or 24 dB/oct (i=3).

Example

OFSL 1 Set the filter slope to 12 dB/oct

OFSL? Returns the filter slope i

SYNC(?) { OFF | ON | i }

The SYNC i command turns the synchronous filter off (i=0) or on (i=1).

Example

SYNC ON Set the synchronous filter to on

SYNC 1

SYNC? Returns the state of the synchronous filter i

ADVFILT(?) { OFF | ON | i }

The ADVFILT i command turns the advanced filter off (i=0) or on (i=1).

Example

ADVFILT ON Set the advanced filter to on

ADVFILT 1

ADVFILT? Returns the state of the advanced filter i

ENBW?

The ENBW? query returns the equivalent noise bandwidth of the output filter, in hertz. Note that the effect of the SYNC filter is neglected by ENBW?

Example

ENBW? Returns the equivalent noise bandwidth, in hertz.

CH1/CH2 Output Commands

COUT(?) [OCH1 | OCH2 | j] { , XY | RTHeta | i }

The COUT j, i command sets CH1 (j=0) or CH2 (j=1) to either XY (i=0) or R θ (i=1).

Example

COUT OCH2, RTHeta Set CH2 to θ
COUT 1, 1

COUT 0, RTH Set CH1 to R
COUT 0, XY Set CH1 to X

COUT? 1 Returns the CH2 output i
COUT? OCH2

CEXP(?) [X | Y | R | j] { , OFF | X10 | X100 | i }

The CEXP j, i command sets the output expand for X (j=0), Y (j=1) or R (j=2) to off (i=0), X10 (i=1) or X100 (i=2). Setting an expand for phase is not allowed.

Example

CEXP Y, X100 Set Y expand to X100
CEXP 1, 2

CEXP? 1 Returns the Y expand mode i
CEXP? Y

COFA(?) [X | Y | R | j] { , OFF | ON | i }

The COFA j, i command turns the output offset for X (j=0), Y (j=1), or R (j=2) to off (i=0) or on (i=1). Setting an offset for phase is not allowed.

Example

COFA X, ON Set X output offset to on
COFA 0, 1

COFA? 0 Returns the X output offset state i
COFA? X

COFP(?) [X | Y | R | j] { , x }

The COFP j, x command sets the output offset percentage for X (j=0), Y (j=1), or R (j=2) to x percent. The value of x is limited to -999.99 to +999.99 with 0.01 resolution.

Example

COFP X, 12.34 Set X output offset to 12.34%
COFA 0, 12.34

COFP? 0 Returns the X output offset percentage x
COFP? X

OAUT [X | Y | R | j]

The OAUT j command auto offsets X (j=0), Y (j=1), or R (j=2). This is the same as Auto Offset in the offset keypad display.

CRAT(?) [X | Y | R | j] { , OFF | ON | i }

The CRAT j, i command turns the ratio function for X (j=0), Y (j=1), or R (j=2) to off (i=0) or on (i=1). Setting an ratio for phase is not allowed.

The ratio function for X and Y are tied to aux input voltage 3, following the equation

$$\text{Output} = \left[\frac{\frac{\text{X or Y}}{\text{Sensitivity}} - \text{Offset}}{\left(\frac{\text{Aux In 3}}{1.000 \text{ V}} \right)} \right] \times \text{Expand} \times 10\text{V}$$

The ratio function for R is similar, but is tied to aux input voltage 4:

$$\text{Output} = \left[\frac{\frac{\text{R}}{\text{Sensitivity}} - \text{Offset}}{\left(\frac{\text{Aux In 4}}{1.000 \text{ V}} \right)} \right] \times \text{Expand} \times 10\text{V}$$

Example

CRAT X, ON
CRAT 0, 1

Set X ratio mode to on

CRAT? 0
CRAT? X

Returns the X ratio mode

Aux Input and Output Commands

OAUX? [j]

The OAUX? j query returns an aux input voltage. The parameter j (0–3) selects aux input 1–4 on the rear panel.

Example

OAUX? 0	Returns the aux in1 voltage v
OAUX? 1	Returns the aux in2 voltage v

AUXV(?) [j] {, v { NV | UV | MV | V } }

The AUXV? j, v command sets an aux output to voltage v. The parameter j (0–3) selects aux output 1–4 on the rear panel. The voltage v can be set from –10.5 V to +10.5 V.

Example

AUXV 2, 678.9 MV	Set aux out3 to 678.9 mV
AUXV 2, 6.789E-1	
AUXV 2, 0.6789	
AUXV? 2	Returns the aux out3 voltage setting in Volts

Auto Function Commands

APHS

The APHS command performs the Auto Phase function. This command is the same as pressing the [Auto Phase] key. The outputs may take many time constants to reach their new values. Do not send the command again without waiting the appropriate amount of time.

ARNG

The ARNG command performs the Auto Range function. This command is the same as pressing the [Auto Range] key. The outputs may take many time constants to return to their steady state values.

ASCL

The ASCL command performs the Auto Scale function. This command is the same as pressing the [Auto Scale] key. This automatically sets the sensitivity. Measurements with the synchronous filter on or measurements of Xnoise or Ynoise may take many time constants to return to their steady state values.

Display Commands

DBLK(?) { OFF | ON | i }

The DBLK i command turns front panel blanking off (i=0) or on (i=1).

Example

DBLK OFF Turn blanking off (displays on)
DBLK 1 Turn blanking on (displays off)

DBLK? Returns the blanking state i

DLAY(?) { TREnd | HISTory | BARHist | FFT | BARFft | BAREight | i }

The DLAY i command sets the screen layout to trend (i=0), full strip chart history (i=1), half strip chart history (i=2), full FFT (i=3), half FFT (i=4) or big numerical (i=5).

Example

DLAY HIST Set the screen layout to full screen strip chart history
DLAY 1

DLAY? Returns the screen layout i

DCAP

The DCAP command saves a screenshot to a USB memory stick. This command is the same as pressing the [Screen Shot] key. A USB memory stick must be present in the front panel USB port.

CDSP(?) [DAT1 | DAT2 | DAT3 | DAT4 | j] { , parameter | i }

The CDSP j, param command assigns a parameter to data channel j. This is the same parameter assignment as pressing the [Config] key.

The value of j (0–3) corresponds to the DAT1 (green), DAT2 (blue), DAT3 (yellow) and DAT4 (orange) data channels.

The parameter list is

i	<u>enumeration</u>	<u>parameter</u>	i	<u>enumeration</u>	<u>parameter</u>
0	X	X output	9	YNOise	Ynoise
1	Y	Youtput	10	OUT1	Aux Out1
2	R	R output	11	OUT2	Aux Out2
3	THeta	θ output	12	PHase	Reference Phase
4	IN1	Aux In1	13	SAMp	Sine Out Amplitude
5	IN2	Aux In2	14	LEVel	DC Level
6	IN3	Aux In3	15	FInt	Internal Reference Frequency
7	IN4	Aux In4	16	FExt	External Reference Frequency
8	XNOise	Xnoise			

Example

CDSP DAT2, IN2 Assign Aux In2 to data channel 2 (blue)
CDSP 3, 15 Assign the Reference Frequency to data channel 4 (orange)
CDSP DAT1, SAM Assign the Sine Out Amplitude to data channel 1 (green)

CDSP? 1 Returns the parameter index assigned to data channel 2 (blue)
 CDSP? DAT2

CGRF(?) [DAT1 | DAT2 | DAT3 | DAT4 | j] { , OFF | ON | i }

The CGRF j, i command turns the strip chart graph of data channel j off (i=0) or on (i=1).

The value of j (0–3) corresponds to the DAT1 (green), DAT2 (blue), DAT3 (yellow) and DAT4 (orange) data channels.

Example

CGRF DAT2, ON Turn graphing on for data channel 2 (blue)
 CGRF 1, 1

CGRF 0, OFF Turn graphing off for data channel 1 (green)

CGRF? 1 Returns data channel 2 (blue) graphing state i
 CGRF? DAT2

GETSCREEN?

The GETSCREEN? query creates and returns a screen image as a binary block of data in BMP file format. *This query cannot be executed over the RS-232 interface.* The file image is the same as is written to a USB memory stick upon pressing the [Screen Shot] key.

After sending GETSCREEN?, the user’s remote program should repeatedly perform a Status Byte query, either by serial poll, or through the VISA Read STB function—but *not* with the *STB? query—until the MAV bit becomes set. Note that it may take several seconds before MAV is set. Once the MAV bit is set in the Status Byte, the user may then read the binary block data. The binary block is in the following format:

```
#nccccxxxxxx
```

Where “#” is the hash character (character code 35), “n” is a single digit specifying the number of digits to follow in the block length count; “cccc” is the n-digit integer size of the binary block to follow, and “xxxxxx” is the cccc-byte binary image file itself. This binary image should be saved as a .BMP format file.

Example

GETSCREEN? Request a screen capture file

The SR860 responds with

```
#535219xxxxxx
```

corresponding to a 35219-byte .BMP file image (the “xxxxxx” data).

Strip Chart Commands

GSPD(?) { i }

The GSPD i command sets the horizontal time/div according to the table below.

i	<u>time/div</u>	i	<u>time/div</u>
0	0.5 s	9	10 min
1	1 s	10	30 min
2	2 s	11	1 hour
3	5 s	12	2 hour
4	10 s	13	6 hour
5	30 s	14	12 hour
6	1 min	15	1 day
7	2 min	16	2 day
8	5 min		

Example

GSPD 6 Set the strip chart to 1 min/div horizontal scale

GSPD? Returns the horizontal scale i

GSCL(?) [DAT1 | DAT2 | DAT3 | DAT4 | j] { , x }

The GSCL j, x command sets the vertical scale of data channel j to x/div. The scale will be set to the nearest allowed scale in a 1-2-5 sequence.

The value of j (0–3) corresponds to the DAT1 (green), DAT2 (blue), DAT3 (yellow) and DAT4 (orange) data channels.

Example

GSCL DAT2, 0.1 Set the vertical scale for data channel 2 (blue) to 0.1/div

GSCL 1, 0.09

GSCL 1, 0.12

GSCL? 1 Returns the vertical scale for data channel 2 (blue)

GSCL? DAT2

GOFF(?) [DAT1 | DAT2 | DAT3 | DAT4 | j] { , x }

The GOFF j, x command sets the vertical offset of data channel j to x.

The value of j (0–3) corresponds to the DAT1 (green), DAT2 (blue), DAT3 (yellow) and DAT4 (orange) data channels.

Example

GOFF DAT3, 0.1 Set the vertical offset for data channel 3 (yellow) to 0.1

GOFF 2, 0.1

GOFF? 2 Returns the vertical offset for data channel 3 (yellow)

GOFF? DAT3

GAUT [DAT1 | DAT2 | DAT3 | DAT4 | j]

The GAUT j command performs an Auto Scale on data channel j. This command is the same as pressing the  button in the scale palette.

The value of j (0–3) corresponds to the DAT1 (green), DAT2 (blue), DAT3 (yellow) and DAT4 (orange) data channels.

Example

GAUT DAT3 Auto Scale data channel 3 (yellow)
GAUT 2

GACT [DAT1 | DAT2 | DAT3 | DAT4 | j]

The GACT j command performs an Auto Scale keeping zero at the center on data channel j. This command is the same as pressing the  button in the scale palette.

The value of j (0–3) corresponds to the DAT1 (green), DAT2 (blue), DAT3 (yellow) and DAT4 (orange) data channels.

Example

GACT DAT1 Auto Scale zero center data channel 1 (green)
GACT 0

GAUF [DAT1 | DAT2 | DAT3 | DAT4 | j]

The GAUF j command performs an Auto Find on data channel j. This command is the same as pressing the  button in the scale palette.

The value of j (0–3) corresponds to the DAT1 (green), DAT2 (blue), DAT3 (yellow) and DAT4 (orange) data channels.

Example

GAUF DAT4 Auto Find data channel 4 (orange)
GAUF 3

CGRF(?) [DAT1 | DAT2 | DAT3 | DAT4 | j] { , { OFF | ON | i } }

The CGRF j, i command turns the graph of data channel j off (i=0) or on (i=1).

The value of j (0–3) corresponds to the DAT1 (green), DAT2 (blue), DAT3 (yellow) and DAT4 (orange) data channels.

Example

CGRF DAT2, ON Turn graphing on for data channel 2 (blue)
CGRF 1, 1

CGRF 0, OFF Turn graphing off for data channel 1 (green)

CGRF? 1 Returns data channel 2 (blue) graphing state i
CGRF? DAT2

GLIV(?) { OFF | ON | i }

The GLIV i command pauses (i=0) or resumes (i=1) the strip chart.

Example

GLIV OFF Pause the strip chart
GLIV 0

GLIV? Returns the strip chart state i

PCUR(?) { i }

The PCUR i command sets the strip chart cursor position i. The right edge is i=0 and the left edge is i=639. The cursor is visible only when the chart is paused.

Example

PCUR 319 Set the strip chart cursor to the middle of the chart

PCUR? Returns the strip cursor position i

CURREL(?) {OFF | ON | i}

The CURREL i command selects relative (i=1) or absolute (i=0) mode for the strip chart cursor. The cursor is visible only when the chart is paused.

If the chart is paused when CURREL transitions from 0 to 1, then the reference marker is located at the present cursor position (set by PCUR). If the chart is live, then the marker is set to the most current bin location (corresponding to the right and edge of the chart); the marker, however, will not become visible until the chart is paused.

Example

CURREL ON Set cursor to relative mode
CURREL 1

CURREL? Returns the cursor relative mode state i

CURDISP(?) {i}

The CURDISP i command sets the cursor horizontal position display mode to date and time (i=0) or interval time (i=1).

Example

CURDISP 0 Set cursor horizontal position to date and time mode

CURDISP? Returns the cursor horizontal position display mode i

CURBUG(?) {AVG | MAX | MIN | i}

The CURBUG i command selects the strip chart cursor readout mode to mean (i=0), maximum (i=1) or minimum (i=2). This command is the same as pressing  in the horizontal scale palette.

Each pixel represents data collected over the time elapsed for one pixel of horizontal scrolling (set by the GSPD command). CURBUG determines whether the cursor readout shows the mean, maximum, or minimum value of the data from within each pixel.

Example	
CURBUG MAX	Set cursor readout to maximum value
CURBUG 1	
CURBUG?	Returns the cursor readout mode i

FCRW(?) { Line | NARrow | Wide | i }

The FCRW i command sets the cursor width to line (i=0), narrow (i=1) or wide (i=2).

This command is the same as pressing  in the horizontal scale palette.

Example	
FCRW NAR	Set the cursor to narrow
FCRW 1	
FCRW?	Returns the cursor width i

SCRY? [DAT1 | DAT2 | DAT3 | DAT4 | STATus | j]

The SCRY? j query returns the strip chart cursor value of data channel j.

The value of j (0–3) corresponds to the DAT1 (green), DAT2 (blue), DAT3 (yellow) and DAT4 (orange) data channels. Querying SCRY? STAT (j=4) returns 0 if there is no overload or unlock at the cursor position. The cursor is only available when the strip chart is paused.

The status response encodes three distinct sources that cause the violet error mark to appear at the bottom of the strip chart display:

Bit	Weight	Definition
0	1	Timebase error
1	2	External reference unlock
2	4	Signal overload
3	8	Sync filter error

Example	
SCRY? DAT2	Returns the cursor value of data channel 2 (blue)
SCRY? STATUS	Returns the error status for the current cursor position

CURDATTIM?

The CURDATTIM? query returns the strip chart cursor horizontal date and time as a string. This string is in the format

28Apr14,14:25:35.96

In this example, the date is 28 April 2014, and the time is 14:25:35.96 (2:25 PM). Performing the CURDATTIM? query when the display is not paused generates a parameter range error.

CURINTERVAL?

The CURINTERVAL? query returns the strip chart cursor horizontal position as a string. This string is in the format

-2d 16:07:30.00

In this example, the cursor position is 2 days, 16 hours, 7 minutes, and 30 seconds before the chart was paused (corresponding to PCUR=171 on the 1 day/division GSPD=15 chart).

When the cursor is in relative mode, CURINTERVAL? returns the interval between the cursor position and the marker position. Performing the CURINTERVAL? query when the display is not paused generates a parameter range error.

FFT Screen Commands

The SR860 has a basic FFT function accessible from the front panel by selecting the appropriate [Screen Layout] display (remotely, by setting DLAY FFT or DLAY BARFFT). A more complete discussion of FFT mode can be found in Appendix B.

Note that while FFT configuration commands and queries may be sent at any time, the FFT data query (FCRY?) only returns valid data while the display is showing the FFT.

FFTR(?) { ADC | MIXer | FILTer | i }

The FFTR i command sets the source for the FFT to input ADC (i=0), post mixer PSD (i=1) or post time constant filter (i=2).

Example

FFTR FILT Set the FFT source to post time constant filter
FFTR 2

FFTR? Returns the FFT source i

FFTS(?) { i }

The FFTS i command sets the FFT vertical scale (dB/div) according to the table below.

<u>i</u>	<u>dB/div</u>	<u>i</u>	<u>dB/div</u>
-8	2 m	0	1.0
-7	5m	1	2.0
-6	10 m	2	5.0
-5	20 m	3	10
-4	50 m	4	20
-3	100 m	5	50
-2	200 m	6	100
-1	500 m	7	200

The argument i is limited to $-20 \leq i \leq 20$. Vertical scale changes preserve the amplitude of the top edge of the graph.

Example

FFTS 4 Set the FFT vertical scale to 20 dB/div

FFTS? Returns the FFT vertical scale i

FFTO(?) { x }

The FFTO x command sets the FFT vertical offset x (dB). This is the amplitude associated with the top edge of the graph.

Example

FFTO -20.0 Set the FFT vertical offset to -20.0 dB

FFTO? Returns the FFT vertical offset

FAUT

The FAUT command performs an Auto Scale on the FFT display. This command is the same as pressing the  button in the FFT vertical scale palette.

FFTMAXSPAN?

The FFTMAXSPAN? query returns the maximum allowed FFT span (Hz/div) for the current FFT source and lock-in configuration (time constant and reference frequency).

Example

FFTMAXSPAN? Returns the maximum allowed FFT span in Hz/div

FFTSPAN(?) { x }

The FFTSPAN x command sets the FFT span to x Hz/div. The value of x may not exceed the maximum allowed span (as returned by FFTMAXSPAN?). The FFT span will be set to the nearest allowed span (max span divided by powers of 2).

Example

FFTSPAN 305 Set the FFT span to 305.2 Hz/div

FFTSPAN? Returns the FFT span in Hz/div

FFTA(?) { AVG1 | AVG3 | AVG10 | AVG30 | AVG100 | i }

The FFTA i command sets the FFT averaging to 1 (i=0), 3 (i=1), 10 (i=2), 30 (i=3) or 100 (i=4).

Example

FFTA AVG3 Set the FFT averaging to 3

FFTA 1

FFTA? Returns the FFT averaging i

FFTL(?) { OFF | ON | i }

The FFTL i command pauses (i=0) or resumes (i=1) the FFT graphing.

Example

FFTL OFF Pause the FFT graph

FFTL 0

FFTL? Returns the FFT graphing i

FCRW(?) { Line | NARrow | Wide | i }

The FCRW i command sets the cursor width to line (i=0), narrow (i=1) or wide (i=2).

Example

FCRW NAR Set the cursor to narrow

FCRW 1

FCRW? Returns the cursor width i

FCRX?

The FCRX? query returns the frequency value of the FFT cursor readout (in Hz). FCRX? is a query only command.

Example

FCRX?

Returns the FFT cursor frequency value

FCRY?

The FCRY? query returns the amplitude value of the FFT cursor readout (in dB). FCRY? is a query only command.

Note that FCRY? only returns valid data when the SR860 display is set to FFT mode.

Example

FCRY?

Returns the FFT cursor amplitude value

Scan Commands

SCNPAR(?) { Fint | REFamp | REFdc | OUT1 | OUT2 | i }

The SCNPAR i command sets the scan parameter to Fint (i=0), Ref Ampl (i=1), Ref dc (i=2), Out1 (i=3) or Out2 (i=4).

Example

SCNPAR F Set the scan parameter to Fint
SCNPAR 0

SCNPAR? Returns the scan parameter i

SCNLOG(?) { LIN | LOG | i }

The SCNLOG i command sets the scan type to linear (i=0) or logarithmic (i=1).

Example

SCNLOG LIN Set the scan type to linear
SCNLOG 0

SCNLOG? Returns the scan type i

SCNEND(?) { ONce | REpeat | UPdown | i }

The SCNEND i command sets the scan end mode to once (i=0), repeat (i=1) or up/down (i=2).

Example

SCNEND REPEAT Set the scan end mode to repeat
SCNLOG 1

SCNLOG? Returns the scan end mode i

SCNSEC(?) { x }

The SCNSEC x command sets the scan time to x seconds. The scan time is limited to 20 days (1728000 seconds).

Example

SCNSEC 1234 Set the scan time to 1234 seconds (20:34)
SCNSEC 1.234E3

SCNSEC? Returns the scan time in seconds

SCNAMPATTN(?) {i}

The SCNAMPATTN i command sets the operating mode for the output attenuators when scanning sine out amplitude to automatic (i=0) or fixed (i=1).

Normally, the sine out hardware will automatically switch one or more balanced attenuators into the output signal path to optimize performance for the commanded amplitude. During scans, however, it can be helpful to force the attenuators to remain in a fixed configuration, inhibiting the relay switching that would otherwise introduce transients in the sine output.

Example

SCNAMPATTN 1	Set the scan amplitude attenuator mode to fixed
SCNAMPATTN?	Returns the mode for amplitude output attenuators

SCNDCATTN(?) {i}

The SCNDCATTN i command sets the operating mode for the output attenuators when scanning dc level to automatic (i=0) or fixed (i=1).

Normally, the sine out dc level hardware will automatically switch one or more balanced attenuators into the dc level signal path to optimize performance for the commanded level. During scans, however, it can be helpful to force the attenuators to remain in a fixed configuration, inhibiting the relay switching that would otherwise introduce transients in the sine output.

Example

SCNDCATTN 1	Set the scan dc level attenuator mode to fixed
SCNDCATTN?	Returns the mode for dc level output attenuators

SCNINRVL(?) {i}

The SCNINRVL i command sets the parameter update interval according to the table below.

i	Update Interval	i	Update interval
0	8 ms	9	9.375 s
1	16 ms	10	28.12 s
2	31 ms	11	56.25 s
3	78 ms	12	112.5 s
4	155 ms	13	5 m 37 s
5	469 ms	14	11 m 15 s
6	938 ms	15	22 m 30 s
7	1.875 s	16	45 m 00 s
8	4.688 s		

The parameter update interval is the approximate time spent at each scan step along the way during a scan.

Example

SCNINRVL 8	Set parameter update interval to 4.688 s
SCNINRVL?	Returns parameter update interval index i

SCNENBL(?) { OFF | ON | i }

The SCNENBL i command turns scanning off (i=0) or on (i=1). This sets the scan parameter to its begin value but does not start a scan.

Example

SCNENBL ON	Turn scanning on
------------	------------------

SCNENBL 1

SCNENBL? Returns the scanning off/on state i

SCNRUN

The SCNRUN command starts or resumes the scan. This command has no effect if the scan is already running.

SCNPAUSE

The SCNPAUSE command pauses the scan. This command has no effect if the scan is already paused.

SCNRST

The SCNRST command resets the scan, regardless of its current state (running or paused). This sets the scan parameter to its begin value but does not start a scan.

SCNSTATE?

The SCNSTATE? query returns the current state of the scan, off or disabled (0), reset (1), running (2), paused (3) or done (4). This is a query only command.

SCNFREQ(?) [BEGiN | ENd | j] { , f { HZ | KHZ | MHZ } }

The SCNFREQ j, f command sets the begin (j=0) or end (j=1) frequency to f. The value of f will be rounded to 6 digits or 0.1 mHz, whichever is greater. The value of f is limited to $1 \text{ mHz} \leq f \leq 500 \text{ kHz}$.

Example

SCNFREQ BEG, 1234 Set the begin frequency to 1.234 kHz
SCNFREQ 0, 1.234 KHZ

SCNFREQ? 0 Returns the begin frequency

SCNAMP(?) [BEGiN | ENd | j] { , v { NV | UV | MV | V } }

The SCNAMP j, v command sets the begin (j=0) or end (j=1) ref amplitude to v. The value of v will be rounded to 3 digits or 1 nV, whichever is greater. The value of v is limited to $1 \text{ nV} \leq v \leq 2.0 \text{ V}$.

Example

SCNAMP ENd, 1.23 Set the end reference amplitude to 1.23 V
SCNAMP 1, 1230 MV

SCNAMP? 1 Returns the end reference amplitude

SCNDC(?) [BEGiN | ENd | j] { , v { NV | UV | MV | V } }

The SCNDC j, v command sets the begin (j=0) or end (j=1) ref dc level to v. The value of v will be rounded to 3 digits or 0.1 mV, whichever is greater. The levels may be programmed from -5.00 V to $+5.00 \text{ V}$.

Example

SCNDC BEGiN, -1.23 Set the begin reference dc level to -1.23 V
SCNDC 0, -1230 MV

SCNDC? 0 Returns the begin reference dc level

SCNAUX1(?) [BEGIN | END | j] { , v { NV | UV | MV | V } }

The SCNAUX1 j, v command sets the begin (j=0) or end (j=1) AuxOut1 value to v. The voltage v can be set from -10.5 V to +10.5 V with 1 mV resolution.

Example

SCNAUX1 BEG, 4.567 Set the begin AuxOut1 value to 4.567 V
SCNAUX1 0, 4567 MV

SCNAUX1? 0 Returns the begin AuxOut1 value

SCNAUX2(?) [BEGIN | END | j] { , v { NV | UV | MV | V } }

The SCNAUX2 j, v command sets the begin (j=0) or end (j=1) AuxOut2 value to v. The voltage v can be set from -10.5 V to +10.5 V with 1 mV resolution.

Example

SCNAUX2 END, 4.567 Set the end AuxOut2 value to 4.567 V
SCNAUX2 1, 4567 MV

SCNAUX2? 1 Returns the end AuxOut2 value

Data Transfer Commands

OUTR? [DAT1 | DAT2 | DAT3 | DAT4 | j]

The OUTR? j query returns the value of data channel j.

The value of j (0–3) corresponds to the DAT1 (green), DAT2 (blue), DAT3 (yellow) and DAT4 (orange) data channels.

Example

OUTR? DAT2 Returns the value of data channel 2 (blue)
OUTR? 1

OUTP? [j]

The OUTP? j query returns the value of a single lock-in parameter. The argument j selects the parameter according to the table below. The enumeration strings may be used instead of the integer value j.

The parameter list is

j	<u>enumeration</u>	<u>parameter</u>	j	<u>enumeration</u>	<u>parameter</u>
0	X	X output	9	YNOise	Ynoise
1	Y	Youtput	10	OUT1	Aux Out1
2	R	R output	11	OUT2	Aux Out2
3	THeta	θ output	12	PHAsE	Reference Phase
4	IN1	Aux In1	13	SAMp	Sine Out Amplitude
5	IN2	Aux In2	14	LEVel	DC Level
6	IN3	Aux In3	15	FInt	Int. Ref. Frequency
7	IN4	Aux In4	16	FExt	Ext. Ref. Frequency
8	XNOise	Xnoise			

Example

OUTP? 1 Returns the value of Y
OUTP? Y

SNAP? [j, k] { , l }

The SNAP? query returns the values of 2 or 3 parameters at a single instant. For example, SNAP? is a way to query values of X and Y (or R and θ) which are taken at the same time. This is important when the time constant is very short. Using the OUTP? or OUTR? commands will result in time delays, which may be greater than the time constant, between reading X and Y.

The SNAP? command requires at least two arguments and at most three. The arguments j, k, l select the lock-in parameters as listed above (see OUTP?). The enumeration strings may be used instead of the integer values for j, k, l.

Example

SNAP? 0,1,4 Returns the values of X, Y and Aux In1
SNAP? X, Y, IN1

The requested values are returned in a single string with the values separated by commas and in the order in which they were requested. In this example, the returned string might be

```
0.951359,0.0253297,1.234
```

The first value is X, the second is Y and the third is Aux In1.

Not all parameters are measured at the same rate within the SR860. The external frequency, for example, is only measured every reference period (at low frequencies). The most recent measurements for these parameters are returned by SNAP?

SNAPD?

The SNAPD? query returns the values of the 4 parameters presently displayed as Data 1 through Data 4, at a single instant. This is equivalent to the SNAP? command (described above), with four parameters returned. The four values returned correspond to the DAT1 (green), DAT2 (blue), DAT3 (yellow) and DAT4 (orange) data channels.

The requested values are returned in a single string with the values separated by commas, and in the order of the Data channel assignments. The assignment of measurable parameters to the four Data channels can be controlled or queried by the CDSP(?) command.

Example

SNAPD?

Returns the values of the four Data channels

After reset, the default assignment of the Data channels is X, Y, R, and θ . In this case, the example may return a string such as:

```
2.3346669042e-09,4.3821726803e-10,2.4805799637e-09,19.749698639
```

Data Capture Commands

Overview

The SR860 can capture data points in an internal capture buffer. This can be up to 1 Mpoints of (X), 512 kpoints of either (X,Y) or (R, θ) or 256 kpoints of (X,Y,R, θ). Data points are stored as floating point values (4 bytes per data point). The capture buffer is made of 2 kbyte blocks (512 total data points per block), but specified in terms of its overall length in kbytes—which must therefore always be an even number of kbytes. The buffer can be configured between 2 kbytes (512 total points) and 4 Mbytes (1,048,576 total points).

The capture buffer is *not* retained when the power is turned off.

Data Format

The captured data is stored and read in 32-bit floating point format. Data is stored and transferred in little endian byte order.

Capture Rate

The capture rate sets how often data points are sampled and added to the capture buffer. All parameters are sampled simultaneously at the same rate. The maximum capture rate is determined by the time constant of the SR860. Shorter time constants allow faster capture rates, up to a limit of 1.25 MHz. The actual capture rate for periodic sampling can be set to the maximum allowed rate divided by factors of 2.

<u>Time constant</u>	<u>Max. capture rate</u> ¹
1 μ s to 10 μ s	1.25 MHz
30 μ s	625 kHz
100 μ s	325 kHz
300 μ s	156.25 kHz
1 ms	78.125 kHz
3 ms to 10 ms	39.0625 kHz
30 ms	9765.62 Hz
100 ms	2441.41 Hz
300 ms	1220.7 Hz
1 s	305.18 Hz
3 s to 30 ks	152.59 Hz

Note that if the time constant is modified *during* a capture, the sampling rate will change mid-capture. This will likely create confusing results and should be avoided.

For the case of one sample per trigger capture (see below), data is stored when a trigger is detected. The hardware trigger rate should never exceed the maximum capture rate, otherwise the SR860 will capture fewer samples than expected.

¹ The maximum capture rate is reduced when the Sync filter is enabled at reference frequencies below 30 Hz.

Capture Time

The entire capture time is the buffer length (number of data points of each parameter) divided by the capture rate. For example, a 4 MByte buffer holds 1 M total data points. If X and Y are captured, the buffer holds 512 kpoints of X ,Y pairs (captured together). The total capture time is thus $(512 \text{ kpoints}) / (1.25 \text{ MHz}) = 0.419$ seconds at the fastest rate.

OneShot or Continuous

When the capture buffer becomes full, data capture can either stop or continue.

The first case is called ‘OneShot’ (data points are captured for a single buffer length). When the buffer fills, data capture stops. Capture may also be stopped early with the CAPTURESTOP command.

The second case is called ‘Continuous’. In this case, data capture continues at the end of the buffer. The buffer will fill and start at the beginning again, overwriting the oldest data. Only the most recent points will be contained in the buffer. Data is recorded until explicitly stopped using the CAPTURESTOP command or by hardware trigger (see below). This can be useful in situations when an external event determines the *end* of when data should be captured (i.e., post-triggering).

When data capture is stopped with the CAPTURESTOP command or by hardware trigger, zeros are written to the remaining portion of the current 2 kbyte block until it is filled. Data is thus always acquired in 2 kbyte blocks, and the point where capture is stopped is where the data becomes zero. The actual number of bytes of real data captured (excluding the zero fill) is reported by the CAPTUREBYTES? query.

Capture Modes

Data capture is started with the CAPTURESTART command. OneShot or Continuous acquisition is specified, as well as the capture Mode. There are three possible Modes: Immediate start, externally triggered start or stop, and one-sample-per-trigger mode.

Immediate start mode begins capturing data immediately. Capture stops when the buffer is filled (OneShot) or when the CAPTURESTOP command is received.

In many situations, it is important to synchronize the beginning or end of data acquisition to an external event. The SR860 supports this with the rear-panel TRIG IN input BNC. To enable a hardware trigger to *start* (but not stop) capture, configure with CAPTURESTART set for OneShot and external trigger. To enable a trigger to *stop* capture (i.e. post-trigger), configure with CAPTURESTART for Continuous and external trigger. In both cases, a *falling edge* at the BNC input triggers the start or stop of capture. The TRIG IN BNC has a 10 k Ω internal pull-up resistor to +3.3 V, giving users flexibility around interfacing.

In one-sample-per-trigger mode mode, a new sample is captured every *falling edge* of the external trigger. The data capture rate is determined by the rate of external triggers, and need not be periodic. The external trigger rate should not exceed the maximum internal data rate of the SR860 reported by the CAPTURERATEMAX? query. One-sample-per-trigger capture is stopped when the buffer is filled (OneShot) or when the CAPTURESTOP command is received.

Once capture has stopped, data in the buffer can be read over the remote interfaces. The `CAPTURESTAT?` query returns the state of the capture. The `CAPTUREBYTES?` query returns the number of data bytes held in the capture buffer (excluding zero fill). These commands may also be used while capture is active to monitor the progress of the capture.

Aliasing Effects

In any sampled data stream, it is possible to sample a high frequency signal such that it will appear to be a much lower frequency. This is called aliasing.

Aliasing occurs whenever the signal being sampled contains signals at frequencies greater than $1/2$ the sample rate. The effect is most noticeable when trying to sample an output frequency at or near an integer multiple of the sample rate.

Generally, choose a capture rate higher than the time constant bandwidth. The lock-in time constant and filter slope should be chosen to attenuate outputs at frequencies higher than $1/2$ the capture rate as much as possible.

CAPTURELEN(?) { n }

The `CAPTURELEN` command sets or queries the capture buffer length. The value n is the buffer length in kilobytes (256 total data points). For example, 32 k points of X and Y is a total of 64 k data points (256 kbytes of buffer at 4 bytes/point) and a length of $n=256$. 32 k points of X , Y , R and θ requires twice as much or a length of $n=512$.

Since the internal blocks that make up the buffer are 2 kbytes each, the value of n must be even and is limited to $1 \leq n \leq 4096$. If n is odd, then the buffer length will be set to $n+1$.

Example

<code>CAPTURELEN 256</code>	Sets the capture buffer length to 256 kbytes or 64 k total data points
<code>CAPTURELEN?</code>	Returns the buffer length n (kbytes)

CAPTURECFG(?) { X | XY | RT | XYRT | i }

The `CAPTURECFG i` command sets the capture configuration to X ($i=0$), X and Y ($i=1$), R and θ ($i=2$) or X , Y , R and θ ($i=3$).

For a given buffer length (total data points), capturing more parameters results in fewer points of each parameter and a shorter total capture time. The capture *rate* is unaffected by `CAPTURECFG`.

Example

<code>CAPTURECFG 1</code>	Capture X and Y
<code>CAPTURECFG XY</code>	
<code>CAPTURECFG?</code>	Returns the capture configuration i

CAPTURERATEMAX?

The CAPTURERATEMAX? query returns the maximum allowed capture rate (at the current time constant) in Hz. This is a query only command.

The actual capture rate can be this maximum rate or this rate divided by powers of 2.

Note that this maximum rate is dependent on the time constant and sync filter settings.

Example

CAPTURERATEMAX? Returns the maximum capture rate in Hz

CAPTURERATE(?) { n }

The CAPTURERATE n command sets the capture rate to the maximum rate divided by 2^n . The value of n is limited to $0 \leq n \leq 20$. Set n=0 for the maximum capture rate.

For example, if CAPTURERATEMAX? returns 78125, then CAPTURERATE 4 will set the capture rate to $(78125)/(2^4) = 4882.8125$ Hz. Note that if the time constant is modified *during* a capture, the sampling rate will change mid-capture.

Note that when capturing one sample per trigger, this setting is ignored and one data sample is always captured as soon as possible after detection of the trigger.

The CAPTURERATE? query returns the actual capture rate in Hz (not the value n).

Example

CAPTURERATE 4 Sets the capture rate to the max rate divided by 2^4

CAPTURERATE? Returns the actual capture rate in Hz

CAPTURESTART [ONEshot | CONTInuous | i], [IMMEDIATE | TRIGstart | SAMPpertrig | j]

The CAPTURESTART i, j command starts data capture for either OneShot (i=0) or Continuous (i=1) acquisition. The parameter j selects whether capture starts immediately (IMMEDIATE start, j=0), is started or stopped by a hardware trigger (TRIGstart, j=1), or captures one sample per hardware trigger (SAMPpertrig, j=2).

The hardware trigger is a TTL input on the rear panel. The active edge of the trigger is a *falling edge*. For hardware triggered start or stop, a triggered start requires using OneShot acquisition, while a triggered stop required using Continuous acquisition.

Both parameters i and j are required in this command.

This command clears any previously captured data and starts a new capture.

Example

CAPTURESTART ONE, IMM Starts OneShot capture immediately

CAPTURESTART 0, 0

CAPTURESTOP

The CAPTURESTOP command stops data capture in any mode.

If the capture is waiting for a hardware trigger to start, then the capture is aborted and the trigger will be ignored.

If capture is in progress, then capture is halted. Any data already captured is preserved and may be read. The remaining space in the current 2kB buffer is filled with zero.

If capture has already ended, the CAPTURESTOP command does nothing.

Example

CAPTURESTOP Stop data capture at the next 2 kB boundary

CAPTURESTAT?

The CAPTURESTAT? query returns the data capture state. This is a query only command.

The returned integer is a 3-bit binary encoded word

Bit	Weight	Definition
0	1	Capture currently in progress
1	2	Capture triggered, either by TTL or remote command
2	4	Capture wrapped

If capture is waiting for a hardware trigger to start capture, then all 3 bits remain 0 until the trigger is received. Once capture is started, bits 0 and 1 both become 1 (giving a return value of 3).

Bit 0 remains 1 while capture is recording data. After receiving the CAPTURESTOP command, bit 0 may remain 1 until the current 2kbyte block of data is filled.

If the capture buffer wraps around, then bit 2 becomes 1; this occurs at the end of a OneShot capture, or when a Continuous capture begins overwriting old data.

Bits 1 and 2, once set, will remain set until cleared by resetting the capture system with a CAPTURECFG, CAPTURELEN or CAPTURESTART command.

Example

CAPTURESTAT? Returns the capture buffer state

CAPTUREBYTES?

The CAPTUREBYTES? query returns the number of bytes of data that have been captured thus far. This query is “live” and may be used to monitor the progress of the capture. For Continuous captures that are overwriting old data, the number of captured bytes decreases by 2048 bytes before increasing again.

After capture has stopped, this query returns the actual number of bytes of non-zero data. For example, an 8kB buffer is being filled with data being captured every trigger. After

capturing 1250 samples of X (5000 bytes of capture), capture is stopped. CAPTUREBYTES? will report 5000 bytes of data, while CAPTUREPROG? will report 6 kB of data as it counts in 2kB increments. CAPTUREVAL? 1249 will return the last sample captured before capture was stopped, and CAPTUREVAL? 1250 will return zero.

Example

CAPTUREBYTES? Returns the amount of data captured, in bytes

CAPTUREPROG?

The CAPTUREPROG? query returns the number of kilobytes of data that were written during the most recent capture acquisition. Capture must be stopped before performing this query.

If the acquisition wrapped during operating in Continuous mode, CAPTUREPROG? will simply return the value of CAPTURELEN.

Example

CAPTUREPROG? Returns the amount of data captured, in kilobytes

CAPTUREVAL? [n]

The CAPTUREVAL? query returns data from the capture buffer in plain text (ASCII) format. Data is returned as comma-separated values of one, two, or four floating point numbers based on the value of CAPTURECFG. Querying with n=0 returns the oldest data from the buffer.

Example

CAPTUREVAL? 3 returns the data from position 3 (the 4th sample)

CAPTUREGET? [i], [j]

The CAPTUREGET? query returns all or part of the capture buffer contents as a binary block. The binary block returns j kbytes of capture buffer contents beginning with an offset of i kbytes. If (i+j) is longer than CAPTURELEN, then CAPTUREGET returns wrapped data.

The maximum length j is 64 (corresponding to 64 kbytes). Both parameters i and j must be provided. Capture must be stopped when executing CAPTUREGET? or a range error is generated.

The binary block query response is in the following format:

```
#nccccxxxxxx
```

Where “#” is the hash character (character code 35), “n” is a single digit specifying the number of digits to follow in the block length count; “cccc” is the n-digit integer size of the binary block to follow, and “xxxxxx” is the cccc-byte binary data. Data is packed as 4-byte (32-bit) single precision floating point binary, in little endian format.

Example

CAPTUREGET? 0,32 returns a binary block with 32 kbytes of capture data

Data Streaming Commands

Overview

See Appendix D for more detailed information about data streaming.

Data Streaming

The SR860 can stream data points continuously in real time over its ethernet interface. This stream can be X values, (XY) or (R θ) values, or (XYR θ) values. Streaming more values uses more ethernet bandwidth. Data points are streamed as either floating point values (4 bytes per data point) or integers (2 bytes per data point). Floating point streaming uses twice the bandwidth.

Data is sent over the ethernet interface in UDP packets containing 132, 260, 516 or 1028 payload bytes. Missed packets are NOT resent. It is important that the receiving computer be able to keep up with the data rate to prevent data loss and interruption.

Streaming Rate

The streaming rate sets how often data points are sampled and added to the stream. All parameters are sampled at the same rate (and at the same times). The maximum allowed streaming rate is determined by the time constant of the SR860, or the signal frequency (when the Sync filter is active). Shorter time constants allow faster streaming rates, up to a limit of 1.25 MHz. The actual streaming rate can be set to the maximum allowed rate divided by factors of 2.

Starting and Stopping

The STREAM ON/OFF command turns streaming on and off. NOTE: Changes to streaming parameters only take effect when streaming is turned back on. So if you want to change e.g. the kind data being streamed, you need to turn streaming off, change the data that is sent, and then turn streaming back on.

Aliasing Effects

In any sampled data stream, it is possible to sample a high frequency signal such that it will appear to be a much lower frequency. This is called aliasing.

Aliasing occurs whenever the signal being sampled contains signals at frequencies greater than 1/2 the sample rate. The effect is most noticeable when trying to sample an output frequency at an integer multiple of the sample rate.

Generally, choose a streaming rate higher than the time constant bandwidth. The lock-in time constant and filter slope should be chosen to attenuate outputs at frequencies higher than 1/2 the streaming rate as much as possible.

STREAMCH(?) { X | XY | RT | XYRT | i }

The STREAMCH i command configures the data streaming to X (i=0), X and Y (i=1), R and θ (i=2) or X, Y, R and θ (i=3).

Example

```
STREAMCH 2           Capture R and  $\theta$ 
STREAMCH RT
```

STREAMCH? Returns the stream configuration i

STREAMRATEMAX?

The STREAMRATEMAX? query returns the maximum allowed streaming rate (at the current time constant and sync filter period) in Hz. This is a query only command.

The streaming rate sets how often data points are streamed to the ethernet interface. All streamed parameters are sampled at the same rate (and at the same times). The maximum streaming rate is determined by the time constant of the SR860. Shorter time constants allow faster streaming rates, and if sync filter is on, shorter sync filter periods allow faster streaming rates, up to a limit of 1.25 MHz. The actual streaming rate can be set to the maximum allowed rate divided by factors of 2.

Example

STREAMRATEMAX? Returns the maximum streaming rate in Hz

STREAMRATE(?) { n }

The STREAMRATE n command sets the streaming rate to the maximum rate divided by 2^n . The value of n is limited to $0 \leq n \leq 20$. Set n=0 for the maximum streaming rate.

For example, if STREAMRATEMAX? returns 78125, then STREAMRATE 4 will set the streaming rate to $(78125)/(2^4) = 4882.8125$ Hz.

The STREAMRATE? query returns the value n.

Example

STREAMRATE 4 Sets the streaming rate to the max rate divided by 2^4

STREAMRATE? Returns the streaming rate n

STREAMFMT(?) { i }

The STREAMFMT i command sets the stream data format to float32 (i=0) or int16 (i=1).

Float32 requires 4 bytes per data point and int16 requires 2 bytes per point. Float32 will use twice the ethernet bandwidth at the same streaming rate as int16.

Int16 values range from -32768 to +32767. Full-scale values (corresponding to Sensitivity, divided by any expand) are returned as the integer 29491 (90% of 32768)..

Example

STREAMFMT 0 Sets the streaming format to float32 (4 bytes per point)

STREAMFMT? Returns the streaming format i

STREAMPCKT(?) { i }

The STREAMPCKT i command sets the ethernet stream packet size to 1024 (i=0), 512 (i=1), 256 (i=2) or 128 (i=3) bytes.

Example

STREAMPCKT 0 Sets the ethernet streaming packet size to 1024 bytes

STREAMPCKT? Returns the streaming packet size i

STREAMPORT(?) { i }

The STREAMPORT i command sets the ethernet streaming to stream to port i, where i is between 1024 and 65535 inclusive. The port should be free and not used by another application on the receiving computer. By default, the port is 1865.

Example

STREAMPORT 12345 Sets the ethernet streaming port to port 12345

STREAMPORT? Returns the streaming port i

STREAMOPTION(?) { i }

The STREAMOPTION i command sets certain advanced features of ethernet streaming. Setting bit 0 true sends data in little-endian format, while setting bit 0 false sends data in big-endian format. Setting bit 1 true enables data integrity checking, while setting bit 1 false disables data integrity checking. By default, data is sent in big-endian format with integrity checking (i=2).

Bit	Weight	Definition
0	1	Use little-endian
1	2	Use data integrity checking

Example

STREAMOPTION 1 Send data in little-endian format, with no integrity checking

STREAMOPTION 3 Send data in little-endian format, with integrity checking

STREAM(?) { OFF | ON | i }

The STREAM i command turns ethernet data streaming off (i=0) or on (i=1).). To enable streaming, the command must be sent over VXI-11 from the receiving computer. This determines the IP address that the data is sent to.

Example

STREAM 1 Turn ethernet streaming on

STREAM ON

System Commands

TIME(?) [SECOnds | MINutes | HOURs | j] { , i }

The TIME j, i command sets the clock value for seconds (j=0), minutes (j=1) or hours (j=2) to i.

Example

TIME MIN, 30 Set the system clock minutes to 30
TIME 1, 30

TIME? MIN Returns the system clock minutes

DATE(?) [DAY | MONth | YEAr | j] { , i }

The DATE j, i command sets the clock value for day (j=0), month (j=1) or year (j=2) to i. The value of i is limited to 0–99.

Example

DATE YEAR, 21 Set system clock year to (20)21
DATE 2, 21

DATE? YEAR Returns the system clock year (last 2 digits)

TBMODE(?) { AUTO | INternal | i }

The TBMODE i command sets the external 10 MHz timebase mode to auto (i=0) or internal (i=1).

Example

TBMODE AUTO Set the timebase mode to auto
TBMODE 0

TBMODE? Returns the timebase mode i

TBSTAT?

The TBSTAT? query returns the current 10 MHz timebase source, either external (0) or internal (1).

Example

TBSTAT? Returns the current 10 MHz timebase

BLAZEX(?) { BLazex | BIsync | UNIsync | i }

The BLAZEX i command sets the rear panel BlazeX output to blazex (i=0), bipolar sync (i=1) or unipolar (positive) sync (i=2).

Example

BLAZEX UNI Set the BlazeX output to unipolar sync
BLAZEX 2

BLAZEX? Returns the BlazeX output selection i

KEYC(?) { ON | MUTE | i }

The KEYC i command turns sounds on (i=0) or off/mute (i=1). This is primarily the key and knob clicks but also includes various system sounds.

Example

KEYC MUTE Turn system sounds off
KEYC 1

KEYC? Returns the system sounds state i

PRMD(?) { SCReen | PRNt | MONOchrome | i }

The PRMD i command sets the screen shot mode to screen (i=0), print (i=1) or monochrome (i=2).

Example

PRMD SCR Set the screen shot mode to screen
PRMD 0

PRMD? Returns the screen shot mode i

SDFM(?) { CSV | MATfile | i }

The SDFM i command sets the data file format to csv (i=0) or Matlab (i=1).

Example

SDFM CSV Set the data file format to csv
SDFM 0

SDFM? Returns the data file format i

FBAS(?) { s }

The FBAS s command sets the file name prefix to the string s. The string s must be within quotes (" "). All letters will be converted to upper case. The string s is limited to 7 characters and may only contain characters which are allowed in DOS file names.

Example

FBAS "F65" Set the file name prefix to "F65"
FBAS "f65"

FBAS? Returns the file name prefix

FNUM(?) { i }

The FNUM i command sets the file name suffix to value i. If the value of i would make the filename exceed 8 characters, the suffix will be set to 0. For example, if the file name prefix is "SR865_" (6 characters) then FNUM i can set the suffix to 0–99 (limited to 2 characters).

Example

FNUM 12 Set the file name suffix to 12

FNUM? Returns the file name suffix

FNXT?

The FNXT? command queries the next file name.

Example

FNXT? Returns the next file name

DCAP

The DCAP command is the same as pressing the [Screen Shot] key. The file save will take some time to complete. A USB memory stick must already be in the front panel USB port.

SVDT

The SVDT command is the same as pressing the [Data Save] key. The file save will take some time to complete. A USB memory stick must already be in the front panel USB port.

Interface Commands

*RST

The *RST command resets the SR860 to its default configurations. The communications setup is not changed. All other modes and settings are set to their default conditions and values. This command takes some time to complete. This command resets any data scan in progress. Data stored in the buffers will be lost. See page 64 for a complete list of setting values that result from *RST.

*IDN?

The *IDN? query returns the SR860's device identification string. This string is in the format

```
Stanford_Research_Systems,SR860,000111,v1.23
```

In this example, the serial number is 000111 and the firmware version is 1.23.

*TST?

The *TST? query always returns "0".

*OPC(?)

The *OPC command sets the Operation Complete bit within the Standard Event Status register (see page 152).

Querying *OPC? Always returns a "1", but does not affect the Standard Event Status register.

LOCL(?) { i }

The LOCL command sets the local/remote function. If i=0 the SR860 is set to LOCAL, if i=1 the SR860 will go REMOTE, and if i=2 the SR860 will go into LOCAL LOCKOUT. The states duplicate the GPIB local/remote states. The LOCL command is not recognized on the RS-232 remote interface.

In the LOCAL state both command execution and keyboard input are allowed.

In the REMOTE state command execution is allowed but the keyboard and knob are locked out except for the [LOCAL] key which returns the SR860 to the LOCAL state.

In the LOCAL LOCKOUT state all front panel operation is locked out, including the [LOCAL] key.

The **REMOTE** indicator is directly above the [LOCAL] key and is on when the unit is in REMOTE or LOCAL LOCKOUT.

The Override Remote mode must be set to Off in order for the front panel to be locked out. If Override Remote is On, then the front panel is active even in the REMOTE state.

Example	
LOCL 1	Set the unit to REMOTE
LOCL?	Returns the local/remote state i

OVRM (?) { OFF | ON | i }

The OVRM command sets the GPIB Override Remote to Off (i=0) or On (i=1). When Override Remote is On, then the front panel is NOT locked out when the unit is in the REMOTE state. The REMOTE indicator will still be on and the [LOCAL] key will still return the unit to the Local state.

The default mode is Override Remote On. To lock-out the front panel, use the OVRM 0 command before local lock-out.

Example	
OVRM 0	Set Override Remote to No
OVRM?	Returns the Override Remote state i

Status Reporting Commands

*CLS

The *CLS command clears all status registers. The status enable registers are NOT cleared.

*ESE(?) {j, } {i}

The *ESE i command sets the **standard event enable register** to the decimal value i (0–255). The *ESE j, i command sets bit j (0–7) to i (0 or 1). The *ESE? command queries the value (0–255) of the standard event enable register. The *ESE? j command queries the value (0 or 1) of bit j.

Example

*ESE 17	Set bits 0 and 4 in the standard event enable register
*ESE 4, 1	Set bit 4 in the standard event enable register
*ESE?	Returns decimal value of the standard event enable register
*ESE? 4	Returns bit 4 of the standard event enable register

*ESR? {j}

The *ESR? command queries the value of the **standard event status byte**. The value is returned as a decimal number from 0 to 255. The *ESR? j command queries the value (0 or 1) of bit j (0–7). Reading the entire byte will clear it while reading bit j will clear just bit j.

Example

*ESR?	Returns decimal value of the standard event status byte
*ESR? 4	Returns bit 4 of the standard event status byte

*SRE(?) {j, } {i}

The *SRE i command sets the **serial poll enable register** to the decimal value i (0–255). The *SRE j, i command sets bit j (0–7) to i (0 or 1). The *SRE? command queries the value (0–255) of the serial poll enable register. The *SRE? j command queries the value (0 or 1) of bit j.

Example

*SRE 12	Set bits 0 and 3 in the serial poll enable register
*SRE 3, 1	Set bit 3 in the serial poll enable register
*SRE?	Returns decimal value of the serial poll enable register
*SRE? 3	Returns bit 3 of the serial poll enable register

*STB? {j}

The *STB? command queries the value of the **serial poll status byte**. The value is returned as a decimal number from 0 to 255. The *STB? j command queries the value (0 or 1) of bit j (0–7). Reading this byte has no effect on its value.

Example

*STB? Returns the decimal value of the serial poll status byte
 *STB? 3 Returns bit 3 of the standard event status byte

***PSC(?) { i }**

The *PSC i command sets the value of the **power-on status clear bit**. If i=1 the power-on status clear bit is set and all status registers and enable registers are cleared on power up. If i=0 the bit is cleared and the status enable registers maintain their values at power down. This allows a service request to be generated at power up. *PSC? queries the value of the power-on status clear bit.

Example

*PSC 1 Set the power-on status clear bit
 *PSC? Returns power-on status clear bit

ERRE(?) { j, } { i }

The ERRE i command sets the **error status enable register** to the decimal value i (0–255). The ERRE j, i command sets bit j (0–7) to i (0 or 1). The ERRE? command queries the value (0–255) of the error status enable register. The ERRE? j command queries the value (0 or 1) of bit j.

Example

ERRE 48 Set bits 4 and 5 in the error status enable register
 ERRE 4, 1 Set bit 4 in the error status enable register
 ERRE? Returns decimal value of the error status enable register
 ERRE? 4 Returns bit 4 of the error status enable register

ERRS? { j }

The ERRS? command queries the value of the **error status byte**. The value is returned as a decimal number from 0 to 255. The ERRS? j command queries the value (0 or 1) of bit j (0–7). Reading the entire byte will clear it while reading bit j will clear just bit j.

Example

ERRS? Returns decimal value of the error status byte
 ERRS? 4 Returns bit 4 of the error status byte

LIAE(?) { j, } { i }

The LIAE i command sets the **lock-in (LIA) status enable register** to the decimal value i (0–4095). The LIAE j, i command sets bit j (0–11) to i (0 or 1). The LIAE? command queries the value of the LIA status enable register. The LIAE? j command queries the value (0 or 1) of bit j.

Example

LIAE 257 Set bits 1 and 8 in the lock-in status enable register
 LIAE 8, 1 Set bit 8 in the lock-in status enable register
 LIAE? Returns decimal value of the lock-in status enable register
 LIAE? 8 Returns bit 8 of the lock-in status enable register

LIAS? {j}

The LIAS? command queries the value of the **lock-in (LIA) status word**. The value is returned as a decimal number from 0 to 4095. The LIAS? j command queries the value (0 or 1) of bit j (0–11). Reading the entire word will clear it while reading bit j will clear just bit j.

Example

LIAS? Returns decimal value of the lock-in status word
 LIAS? 8 Returns bit 8 of the lock-in status byte

CUROVLDSTAT?

The CUROVLDSTAT? command queries the present overload states of the lock-in. These overloads reflect the state of the lock-in at the time the command is processed. They are NOT set until read.

The value is returned is a decimal number from 0 to 4095 where the bits are defined below.

Bit	Weight	Definition
0	1	CH1 output scale
1	2	CH2 output scale
2	4	unused
3	8	External reference unlocked
4	16	Input range
5	32	unused
6	64	unused
7	128	unused
8	256	Data Channel 1 scale
9	512	Data Channel 2 scale
10	1024	Data Channel 3 scale
11	2048	Data Channel 4 scale

Example

CUROVLDSTAT? Returns decimal value of the overload status word

Status Byte Definitions

The SR860 reports on its status by means of four status bytes: the Serial Poll Status byte, the Standard Event Status byte, the LIA Status byte, and the Error Status byte.

The status bits are set to 1 when the event or state described in the tables below has occurred or is present.

Serial Poll Status Byte

<u>bit</u>	<u>name</u>	<u>usage</u>
0		unused
1		unused
2	ERR	An enabled bit in the error status byte has been set.
3	LIA	An enabled bit in the LIA status byte has been set.
4	MAV	The interface output buffer is non-empty.
5	ESB	An enabled bit in the standard status byte has been set.
6	SRQ	SRQ (service request) has occurred.
7		unused

The ERR, LIA, and ESB bits are set whenever any bit in BOTH their respective status bytes AND enable registers is set. Use the *SRE, *ESE, ERRE and LIAE commands to set enable register bits. The ERR, LIA and ESB bits are not cleared until ALL enabled status bits in the Error, LIA and Standard Event status bytes are cleared (by reading the status bytes, using *CLS or by clearing the enable register bits).

Using *STB? command to read the Serial Poll Status Byte

A bit in the Serial Poll status byte is NOT cleared by reading the status byte using *STB?. The bit stays set as long as the status condition exists. This is true even for SRQ. SRQ will be set whenever the same bit in the serial poll status byte AND enable register is set. This is independent of whether a serial poll has occurred to clear the service request.

Using GPIB Serial Poll

Except for SRQ, a bit in the Serial Poll status byte is NOT cleared by GPIB serial polling the status byte. When reading the status byte using a GPIB serial poll, the SRQ bit signals that the SR860 is requesting service. The SRQ bit will be set (1) the first time the SR860 is polled following a service request. The GPIB serial poll automatically clears the service request SRQ. Subsequent GPIB serial polls will return SRQ cleared (0) until another service request occurs.

Polling the status byte and reading it with *STB? can return different values for SRQ. When polled, SRQ indicates a service request has occurred. When read, SRQ indicates that an enabled status bit is set.

GPIB Service Requests (SRQ)

A GPIB service request (SRQ) will be generated whenever a bit in both the Serial Poll Status byte AND Serial Poll Enable register is set. Use *SRE to set bits in the Serial Poll Enable register. A service request is only generated when an enabled Serial Poll Status bit becomes set (changes from 0 to 1). An enabled status bit which becomes set and remains

set will generate a single SRQ. If another service request from the same status bit is desired, the requesting status bit must first be cleared. In the case of the ERR, LIA and ESB bits, this means clearing the enabled bits in the ERR, LIA and ESB status bytes (by reading them). Multiple enabled bits in these status bytes will generate a single SRQ. Another SRQ (from ERR, LIA or ESB) can only be generated after clearing the ERR, LIA or ESB bits in the Serial Poll status byte. To clear these bits, ALL enabled bits in the ERR, LIA or ESB status bytes must be cleared.

The controller should respond to the SRQ by performing a serial poll to read the Serial Poll status byte to determine the requesting status bit. Bit 6 (SRQ) will be reset by the serial poll.

For example, to generate a service request when a reference UNLK occurs, bit 3 in the LIA Status Enable register needs to be set (LIAE 3,1 command) and bit 3 in the Serial Poll Enable register must be set (*SRE 3,1 command). When a reference unlock occurs, bit 3 in the LIA Status byte is set. Since bit 3 in the LIA Status byte AND Enable register is set, this ALSO sets bit 3 (LIA) in the Serial Poll Status byte. Since bit 3 in the Serial Poll Status byte AND Enable register is set, an SRQ is generated. Bit 6 (SRQ) in the Serial Poll Status byte is set. Further reference unlocks will not generate another SRQ until the UNLK status bit is cleared. The UNLK status bit is cleared by reading the LIA Status byte (with LIAS?). Presumably, the controller is alerted to the unlock via the SRQ, performs a serial poll to clear the SRQ, does something to try to remedy the situation (change frequency, experimental parameters, etc.) and then clears the UNLK status bit by reading the LIA status register. A subsequent UNLK overload will then generate another SRQ.

Standard Event Status Byte

<u>bit</u>	<u>name</u>	<u>usage</u>
0	OPC	Operation complete (set by the *OPC command)
1	INP	Input queue overflow (too many commands received at once, queues cleared).
2		unused
3	QRY	Output queue overflow (too many responses waiting to be transmitted, queues cleared).
4	EXE	A command cannot execute correctly or a parameter is out of range.
5	CMD	An illegal command is received.
6	URQ	Set by any user front panel action.
7	PON	Set by power-on.

The bits in this register remain set until cleared by reading them or by the *CLS command.

Lia Status Word

<u>bit</u>	<u>name</u>	<u>usage</u>
0	CH1OV	CH1 output scale overload
1	CH2OV	CH2 output scale overload
2		unused
3	UNLK	External reference or Chop unlock detected.
4	RANGE	Input range overload detected
5	SYNCF	Sync filter frequency out of range
6	SYNCOV	Sync filter overload
7	TRIG	Set when data storage is triggered
8	DAT1OV	Data Channel 1 scale overload
9	DAT2OV	Data Channel 2 scale overload
10	DAT3OV	Data Channel 3 scale overload
11	DAT4OV	Data Channel 4 scale overload
12	DCAPFIN	Display capture to USB stick completed
13	SCNST	Scan started
14	SCNFIN	Scan completed

The LIA Status bits stay set until cleared by reading or by the *CLS command.

Error Status Byte

<u>bit</u>	<u>name</u>	<u>usage</u>
0	CLK	External 10 MHz clock input error.
1	BACKUP	Battery backup failed.
2		unused
3		unused
4	VXI	VXI-11 error.
5	GPIB	GPIB fast data transfer mode aborted.
6	USBDEV	USB device error (interface error).
7	USBHOST	USB host error (memory stick error).

The Error Status bits stay set until cleared by reading or by the *CLS command.

Appendix A

Advanced Filters

Traditionally, analog lock-in amplifier time-constant filters were cascaded single-pole RC sections. These are easy to construct, require minimal tuning, and have familiar time and frequency domain characteristics. But with the advent of digital lock-in amplifiers, anything is possible as far as filters are concerned. So let us consider what is possible, what is optimal, and what a lock-in user would want in digital filter.

Different filters have different time domain characteristics, such as rise time and overshoot, and different frequency domain characteristics, such as noise bandwidth and attenuation slope. These characteristics are inextricably linked. It is impossible to arbitrarily specify both the frequency response of the filter and its time domain response. That is why when we impose frequency domain restrictions such as “brick-wall” type attenuation characteristics they come back to haunt us in the form of poor time domain behavior, such as large overshoot.

Lock-in outputs are fundamentally time-domain outputs and this limits how aggressively we can specify the frequency domain characteristics of our time constant filters. Nevertheless, there are filters other than simple RC filters which offer quantifiable benefits to lock-in users.

What are these benefits? For two filters with the same noise bandwidth, i.e. whose outputs would be equally noisy if the input was white noise, a lock-in user would always prefer a filter with a faster transient response and minimal overshoot. And a lock-in user would always prefer a filter with higher stop band attenuation to ensure greater suppression of out-of-band spurs. These are the characteristics we will concentrate on.

To use the advanced filters in place of the RC filters press and hold the [Slope/adv] key until the **Advanced** LED turns on. Brief presses of [Slope/adv] cycles the number of poles from 1 to 4 (6 to 24 dB). Another press and hold of the [Slope/adv] key reverts the filters back to RC filters and turns off the **Advanced** LED.

Gaussian FIR Filter

When the time constant is 3 s or shorter, an advanced Gaussian FIR filter pole of equivalent noise bandwidth (ENBW) is substituted for an RC filter pole.

The Gaussian filter has a faster settling time than the RC filter, since it lacks the RC filter's agonizing “exponential tail”. The one-stage Gaussian filter gets to within 1% of its final value twice as fast as the RC filter!

The Gaussian filter has better rejection of high frequencies than the RC filter. The Gaussian filter has a constant 11.6 dB more rejection of high frequencies (per stage) than

the RC filter. Thus, a four-stage Gaussian filter rejects high frequencies $4 \times 11.6 \text{ dB} = 46 \text{ dB}$ better than a four-stage RC filter.

The Gaussian filter has a flatter pass band than the RC filter. The -3dB bandwidth of the Gaussian filter is 1.5 times greater than that of the RC filter.

One disadvantage of the Gaussian filter is the increased latency as more stages are added. When 4 stages of Gaussian filtering are used, there is seemingly no response for several time constants before the output quickly rises.

Lock-in users have long complained that traditional RC filters are “slow”, i.e. for a given width in the frequency domain they take the longest time to reach a given percentage of their final value. Notice that the FIR filter reaches 99% of its final value more than twice as fast as the RC filter. The FIR filter also attenuates signals above $f_{3\text{dB}}$ much more.

The FIR filter is ideal when the experiment is sweeping a parameter and faster response time translates to faster sweeping, better peak definition and peak symmetry.

What’s the drawback? The FIR $f_{3\text{dB}}$ is 50% greater than the RC. This means signals near dc might not be attenuated as much as the RC filter.

The SR860 implements multiple poles of FIR filtering by simply adding identical poles in succession. Because the Gaussian filter is computationally intensive it is not available for time constants longer than 3s.

Linear Phase Filter

For time constants of 10 s through 30000 s, the advanced filter is a Linear Phase IIR filter with same attenuation slope as the RC filters of the same time constant and number of poles. In other words, the Linear Phase filter’s stop band is aligned with the corresponding RC filter.

For 1 pole of filtering, the Linear Phase and RC filter are identical.

For a given stop band attenuation, the 2 pole Linear Phase filter reaches 99% of its final value almost twice as fast as the RC filter. There is slight penalty in ENBW and overshoot but at these longer time constants, the long wait times of the RC filter can make the experiment exceptionally arduous.

In Real Life

In an actual experimental situation, the signal is never simple. If the goal is to read a static output value, then longer time constants will achieve that. If the output value is changing because of parameter sweeping or a signal turning on and off, then the advanced filters can be of great help. In practice it is simple to try these filters, at various time constants and number of poles, in comparison with RC filters. They often yield better results in less time.

Closed Loop Applications

If the lock-in output X is used in a feedback loop, the filter should always be a single RC pole. Advanced filtering may lead to oscillations in the loop.

The BlazeX output is always an RC filter (1 to 4 poles) regardless of the front panel Advanced Filter setting. This is because the BlazeX output is intended for feedback applications that require low latency.

Summary of Filter Characteristics

The chart below summarizes the speed of the different filters. (also see Step Response graphs on the following pages).

Time to settle to within 1% of final value (in time constants)			
Stages	RC	Gaussian	Linear Phase
1	4.6	2.3	4.6
2	6.6	4.0	4.4
3	8.4	5.6	4.8
4	10.0	7.1	5.4

The chart below summarizes the noise bandwidth of the different filters. Note that for a single stage, all 3 filters are designed with the same noise bandwidth.

Equivalent Noise Bandwidth (fraction of $f_c=(2\pi\times\text{time constant})^{-1}$)			
Stages	RC	Gaussian	Linear Phase
1	1.6	1.6	1.6
2	0.79	1.1	0.93
3	0.59	0.94	0.83
4	0.5	0.81	0.78

Frequency Response Graphs

These graphs illustrate the frequency response of the different filters at 12 and 24 dB/oct. Each stage of the Gaussian filter has the same ENBW as a single stage of the RC filter. Each stage of the Linear Phase filter has the same roll-off as a single stage of the RC filter.

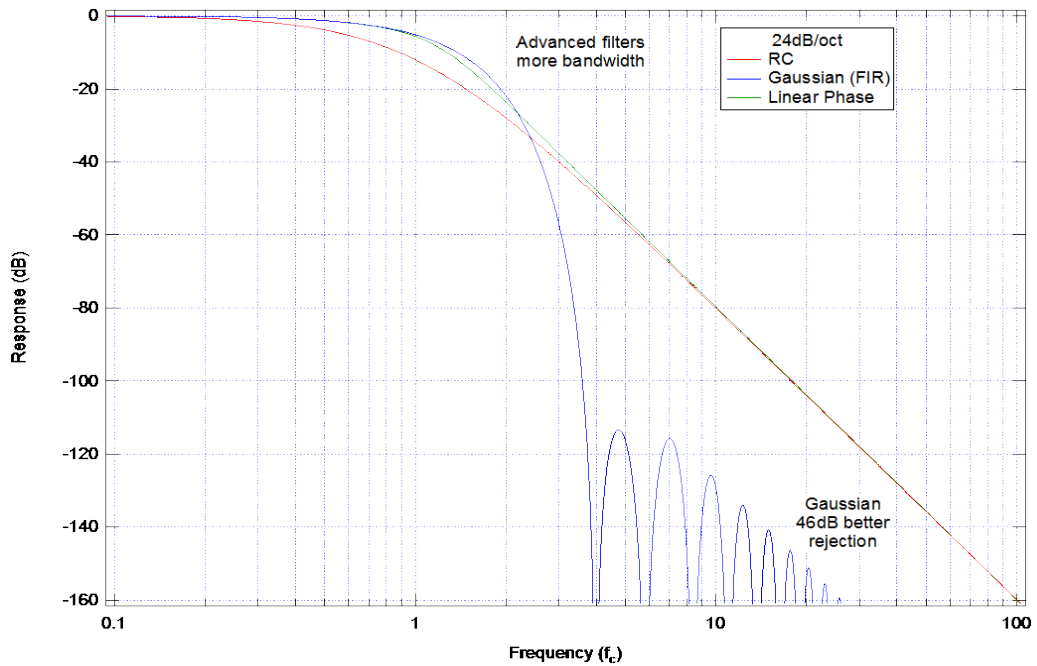
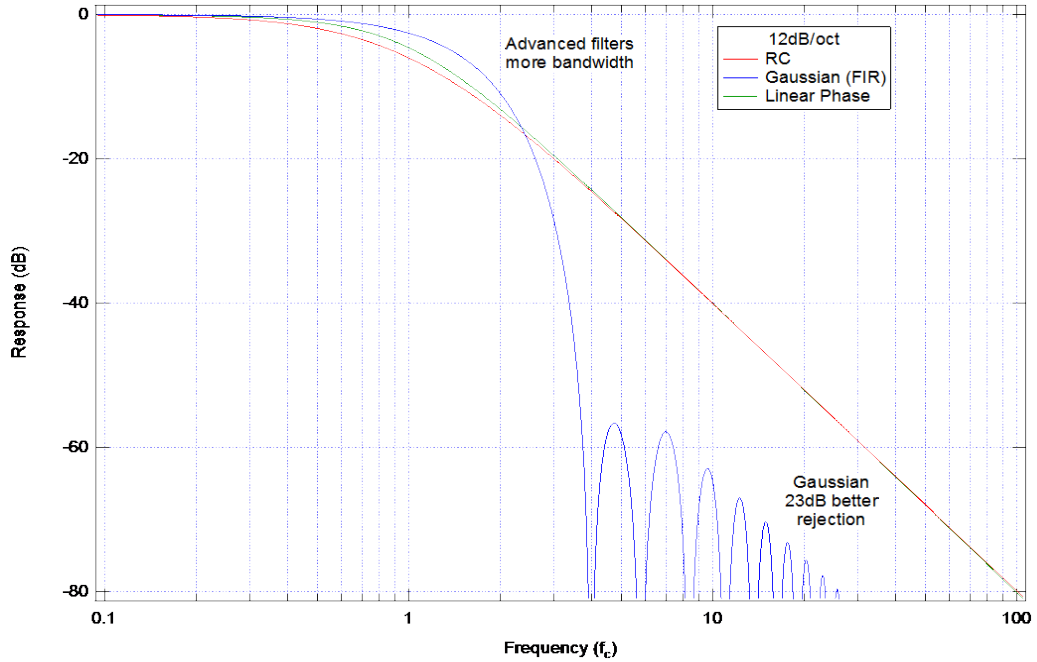

Step Response Graphs

These graphs illustrate the step response of the different filters at 12 and 24 dB/oct. The advanced filters always settle less time than the RC filters. Gaussian filters have increasing latency with more stages. Linear Phase filters have $\leq 1\%$ overshoot.

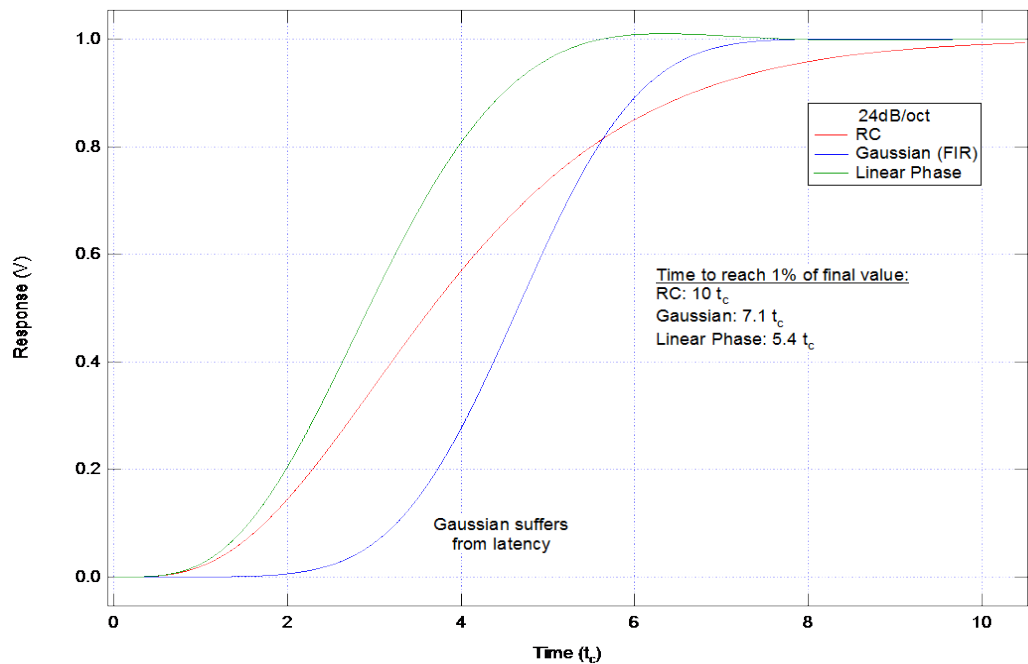
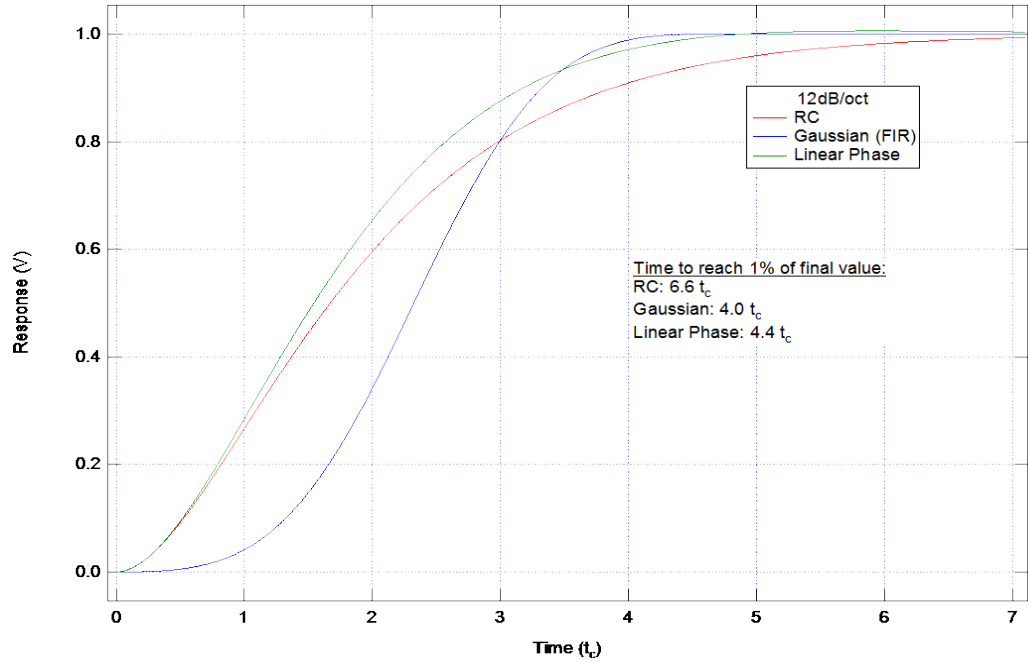

Typical Output Latency

The following oscilloscope image shows an example of the reduced output latency when using the BlazeX output. In this example, the input signal is a ~ 500 kHz sinewave that abruptly changes from 10 mVrms to ~ 20 mVrms. The output filter is configured as RC, 18 dB/oct., with a $1\ \mu\text{s}$ time constant. Notice the BlazeX output begins responding to the amplitude step change after only $1.7\ \mu\text{s}$, while the regular X output does not begin to respond until after $10\ \mu\text{s}$.

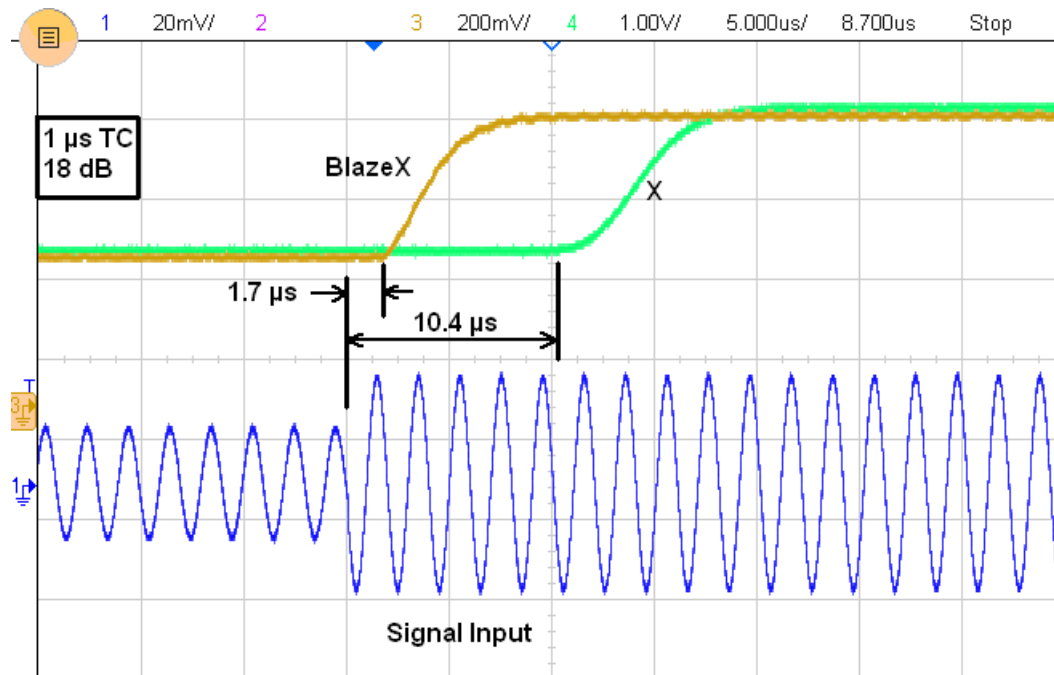

Appendix B

The FFT Display

The FFT display takes a time varying signal, like you would see on an oscilloscope trace, and computes its frequency spectrum. In the SR860, this signal is either the output of the input amplifier (Raw ADC) or the output of the PSD (Post Mixer or Post Filter).

Fourier's basic theorem states that any waveform in the time domain can be represented by the weighted sum of pure sine waves of all frequencies. If the signal in the time domain (as viewed on an oscilloscope) is periodic, then its spectrum is probably dominated by a single frequency component. What the FFT does is represent the time domain signal by its component frequencies.

Why Look at the Spectrum?

A lock-in amplifier measures a single frequency component of the input signal at f_{ref} . With time constant filtering, all other frequencies are ignored and filtered away. Sometimes it can be useful to see what's going on at other frequencies, even if only with a broad overview. This can help identify sources of interference or noise. Other times it may be useful for estimating the signal at other frequencies without making multiple measurements, each at different reference frequencies and time constants. Take harmonic distortion. Instead of making separate measurements at f_{ref} , $2 \times f_{\text{ref}}$, $3 \times f_{\text{ref}}$, etc. the FFT can display the harmonic frequencies and amplitudes with amazing clarity in a single measurement. Another example is noise analysis. In an FFT, the noise as a function of frequency is displayed.

The FFT Analyzer

The lock-in amplifier digitizes the input signal and multiplies by f_{ref} in a phase sensitive detector yielding a very narrow band measurement at f_{ref} .

An FFT analyzer works in an entirely different way. A time record of samples (1024 samples in the SR860) is mathematically transformed into a frequency spectrum using an algorithm known as the Fast Fourier Transform or FFT. The FFT is simply a clever set of operations which implements Fourier's basic theorem. The resulting spectrum shows the frequency components of the input signal.

Now here's the interesting part. The original digital time record comes from discrete samples taken at the sampling rate. The corresponding FFT yields a spectrum with discrete frequency samples. In fact, the spectrum has half as many frequency points as there are time points. (Remember Nyquist's theorem). Suppose that you take 1024 samples at 256 kHz. It takes 4 ms to take this time record. The FFT of this record yields 512 frequency points, but over what frequency range? The highest frequency will be determined by the period of 2 time samples or 128 kHz. The lowest frequency is just the period of the entire record or $1/(4 \text{ ms})$ or 250 Hz. Everything below 250 Hz is considered

to be dc. The output spectrum thus represents the frequency range from dc to 128 kHz with points every 250 Hz.

Advantages and limitations

The advantage of this technique is its speed. The entire spectrum takes only 4 ms to measure. The limitation of this measurement is its resolution. Because the time record is only 4 ms long, the frequency resolution is only 250 Hz. Suppose the signal has a frequency component at 260 Hz. The FFT spectrum will detect this signal but place part of it in the 250 Hz point and part in the 500 Hz point. In fact, the way to measure the signal accurately is to lengthen the time record and change the resolution of the spectrum. Of course eventually you end up with a very long measurement of a very narrow spectrum — much like a lock-in amplifier. At this point, you lose the FFT advantage and should indeed rely on the lock-in measurement.

FFT's in the SR860

The SR860 FFT display is not a replacement for a full FFT spectrum analyzer instrument. It is intended to give the user an overview of the spectrum of the input signal or the output of the PSD and time constant filters.

The length of the time record is always 1024 points, the maximum span of an output FFT is determined by the time constant, the window is Kaiser and the averaging is rms. The amplitude is always dB (Vrms) and is uncalibrated (only accurate to a few dB). None of this can be changed.

Important Facts About SR860 FFT's

1. The acquisition time of a spectrum (averaging off) is equal to the time record. Narrow frequency spans means long time records. The time record is about $500/\text{span}$ (Hz). Changing the measurement in narrow spans means waiting for at least a time record for a spectrum.
2. The lock-in time constant determines the maximum span for post filter FFT's. Using a long time constant means having a long FFT time record.
3. The frequency scale is labelled with respect to the signal's frequency at the input BNC. Thus a signal at f_{ref} , which appears at dc at the lock-in output, will be labelled as f_{ref} in the FFT.
4. Amplitudes are uncalibrated. Amplitude measurements are generally accurate to a few dB.

Using the FFT Display

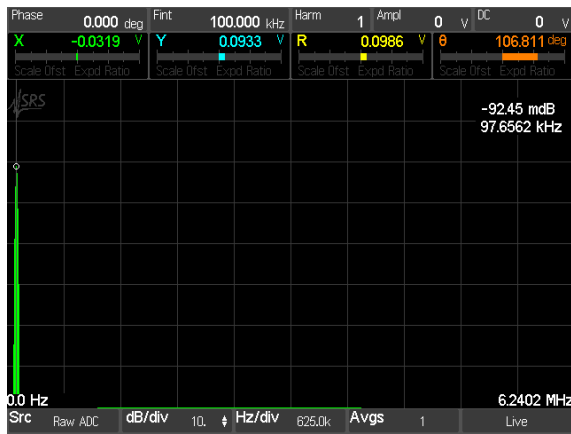

This example is designed to use the SR860 internal oscillator and an external signal source to explore some the FFT display. You will need a synthesized function generator capable of providing a 100 mVrms sine wave at 100.000 kHz, BNC cables and a terminator appropriate for the generator function output. You will display the FFT when measuring a signal close to, but not equal to, the internal reference frequency. This setup will illustrate the input and output FFT's.

Do This	Explanation
<ol style="list-style-type: none"> 1. Disconnect all cables from the lock-in. Turn the power on while holding down the [Local] key. The power switch is on the power entry module on the rear panel. 2. Turn on the function generator, set the frequency to 100.000 kHz (exactly) and the amplitude to 100 mVrms. Connect the function output (sine wave) from the synthesized function generator to the A input using a BNC cable and appropriate terminator. 	<p>When the power is turned on with [Local] pressed, the lock-in returns to its standard default settings. See the Standard Settings list in the Operation section for a complete listing of the settings.</p> <p>The input impedance of the lock-in is 10 MΩ. The generator may require a terminator. Many generators have either a 50Ω or 600Ω output impedance. Use the appropriate feedthrough or T termination if necessary. In general, not using a terminator means that the function output amplitude will not agree with the generator setting.</p>
	<p>The SR860 is set to an internal reference of 100.000 kHz. This should be very close to the external generator frequency. The X (green) and Y (blue) displays should read values which change slowly. The lock-in and the generator are not phase locked but they are at the same frequency with a slowly changing θ (orange). The signal magnitude R (yellow) is phase independent and does not change.</p> <p>You can adjust the generator frequency slightly to get closer to the SR860.</p>
<ol style="list-style-type: none"> 15. Press [Screen Layout] multiple times to change the display to the full screen FFT. 	<p>The FFT of the signal input is displayed. There is only a single quantity shown.</p> <p>The left and right edge frequencies are labelled at the bottom of the graph. The cursor readout is at the right.</p> <p>The display is adjusted with the tiles across the bottom. {Src} selects the source data for the FFT. {dB} and {Hz} adjust the vertical and horizontal scales. {Aves} sets the amount of averages and {Live} toggles to {Paused}.</p>





3. Touch the {dB/div} scale tile at the bottom to display its scale palette.

Touch  to auto scale the FFT.

Touch and drag in the graph area to move the graph up and down or use the  and  buttons.

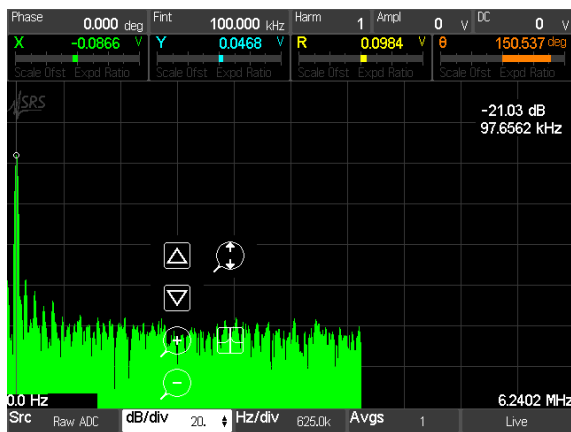
Use the <Cursor> knob to move the marker onto the signal peak.



Touch  to change the width of the cursor. In the FFT display, the wide cursors always find the peak within the cursor region. This makes reading an FFT much easier.

Touch the highlighted {dB/div} tile again to dismiss the scale palette.

3. Touch the {Hz/div} tile along the bottom to display the span up/down buttons.

Use the <Cursor> knob to move the cursor.

The vertical axis is always logarithmic in the FFT display. This allows a large dynamic range to be shown in a single graph.

The amplitude is not calibrated.

Notice that the cursor readout at the upper right reads the peak amplitude and frequency. This is the signal from the external generator. The peak is about -20 dB or 0.1 Vrms. The cursor reads 97.6562 kHz. This is because at this full span, the FFT frequency bins are 9.76 kHz apart and the 100.00 kHz signal falls mostly in the 97.6562 kHz bin.

The FFT frequency span can be reduced to provide better frequency resolution. When the FFT source is Raw ADC, the FFT display is

Touch  3 times to decrease the frequency scale to 39.06 kHz/div.

Move the cursor back to the peak.

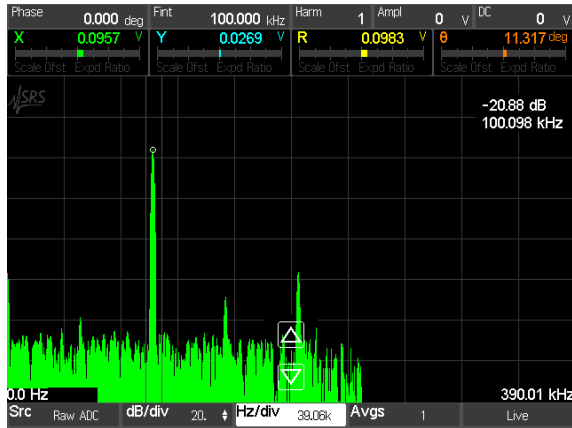

4. Touch the {Aavs} tile along the bottom to display the averaging up/down buttons.

Touch  twice to increase the number of averages to 10.

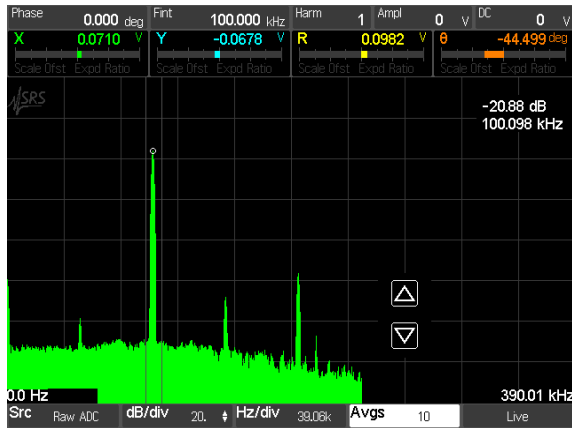

Touch  twice to decrease the number of averages to 1.

5. Touch the {Live} tile along the bottom to pause the FFT display.

Touch {Paused} to return to a live display.

Press the [Time Constant Down] key multiple times to set the time constant to 1 ms.

always baseband (i.e. the frequency span starts at 0 Hz or dc).

The cursor readout now reads 100.098 kHz because each frequency bin has been reduced to 0.6 kHz.

FFT graphs can be averaged to reduce fluctuations. Averaging is exponential in the number of averages.

Turn the averaging off to speed up the display.

The FFT may be paused.



When the FFT source is set to the PSD output, the maximum frequency span is set by the time constant. The shorter the time constant, the higher the maximum frequency span. This is

6. Touch the {Src} tile along the bottom to display the source up/down buttons.

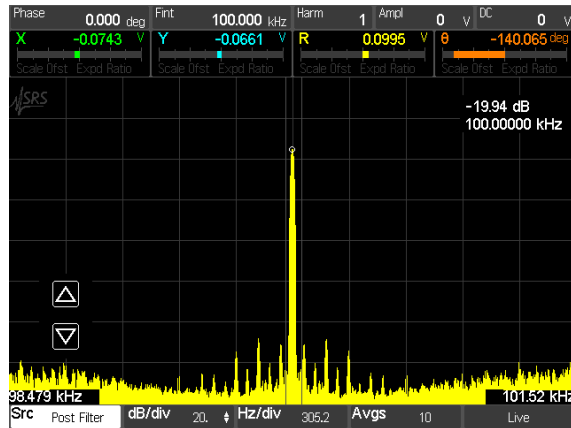
Touch  repeatedly to change the source to Post Filter.



7. Touch the {Hz/div} tile along the bottom to display the span up/down buttons.

Use the  and  buttons to set the Hz/div to 305.2 Hz. The total span is about 1 kHz.

8. Increase the external generator frequency to 101.000 kHz. Move the cursor to the peak.

Decrease the external generator frequency to 99.000 kHz.

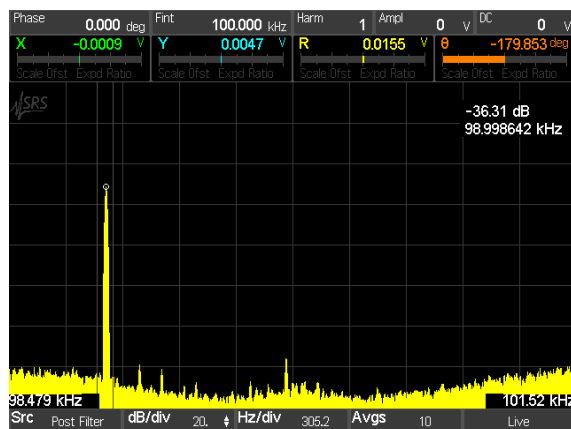

9. Leave the external generator at 99.000 kHz. Move the cursor to the signal peak.

because the PSD output is frequency limited by the time constant filters.

The FFT of the PSD filtered output is displayed. This display is presented as a zoomed spectrum (the same as a spectrum analyzer). The center of the span is the lock-in reference frequency. Signals to the right of center are above the f_{ref} , signals to the left are below f_{ref} . The center frequency is the signal at f_{ref} .

Note that this is not the same as connecting the lock-in output BNC to a spectrum analyzer.

At a 1 ms time constant the maximum span is about 50 kHz (4.883 kHz/div). At a 1 s time constant, the maximum span is 1.6 kHz (152.6 Hz/div).

The signal peak moves to the right of center and the cursor reads 101.00 kHz.

The signal peak moves to the left of center and the cursor reads 99.00 kHz.

Both of these signal frequencies will appear at the lock-in output at 1.00 kHz ($|f_{sig} - f_{ref}|$). Any signal at f_{ref} appears at the lock-in output at dc.

On the FFT display, these signals are shown at their true input frequencies.

Note that the peak amplitude is diminished from its value at 100.000 kHz. The readout is about -36 dB. This is because the lock-in time

Press the [Filter Slope] key once to increase the filter slope to 12 dB/oct.

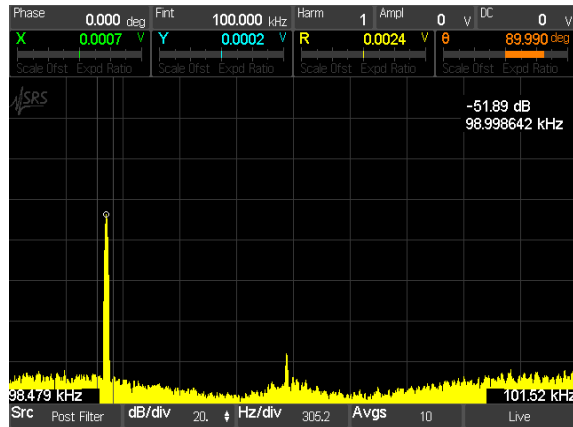

constant acts like a bandpass filter in the spectrum centered at f_{ref} (center).

The peak amplitude at 99.000 kHz is diminished even further. This is the effect of the steeper time constant filter.

At the lock-in output, the 1 kHz output is attenuated further by this filter.

This example has provided a quick overview of the FFT display in the SR860.

Appendix C

Using the Webserver

The SR860 webserver provides a quick start to interfacing via ethernet. Make sure to set the IP address, subnet mask and gateway address for your network in the system ethernet menu. Be sure to enable the webserver in the VXI-11 & Web settings. Press and hold [Calc/system] to access the system menu.

To bring up the unit's webpage, simply type the unit's IP address into the browser bar of a computer which can access the same subnet. Note that typical installations do not allow the unit to be seen on the internet, only on the internal subnet. For full internet access, consult with your IT administrator.

The homepage is shown below. Various instrument properties are displayed. This is an easy way to check the ethernet settings without writing any software.

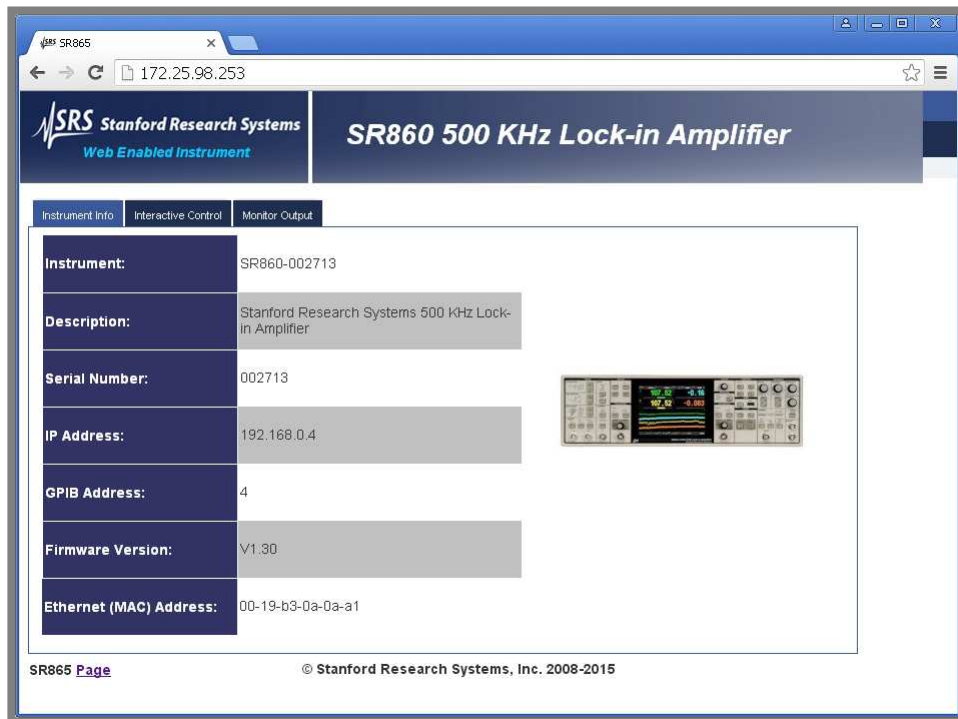

Click on the Interactive Control tab to display the command screen. Here you can try sending commands or queries and checking the responses to SR860 commands. Click on the SR860 Command List link to see the commands.

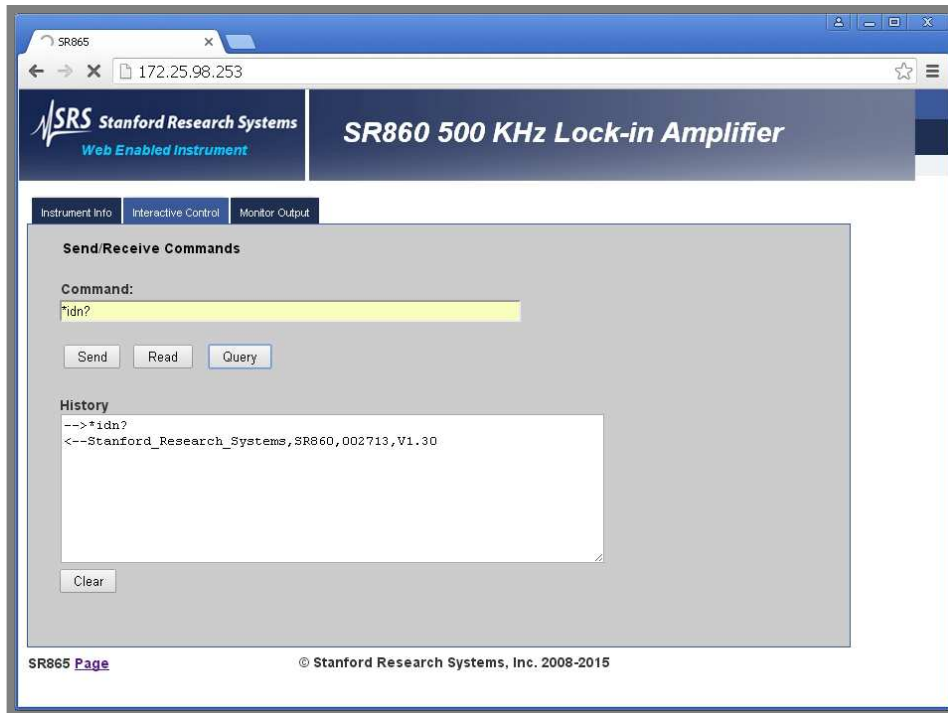

Click the Monitor Output tab to display a simple readout of the 4 data channels.

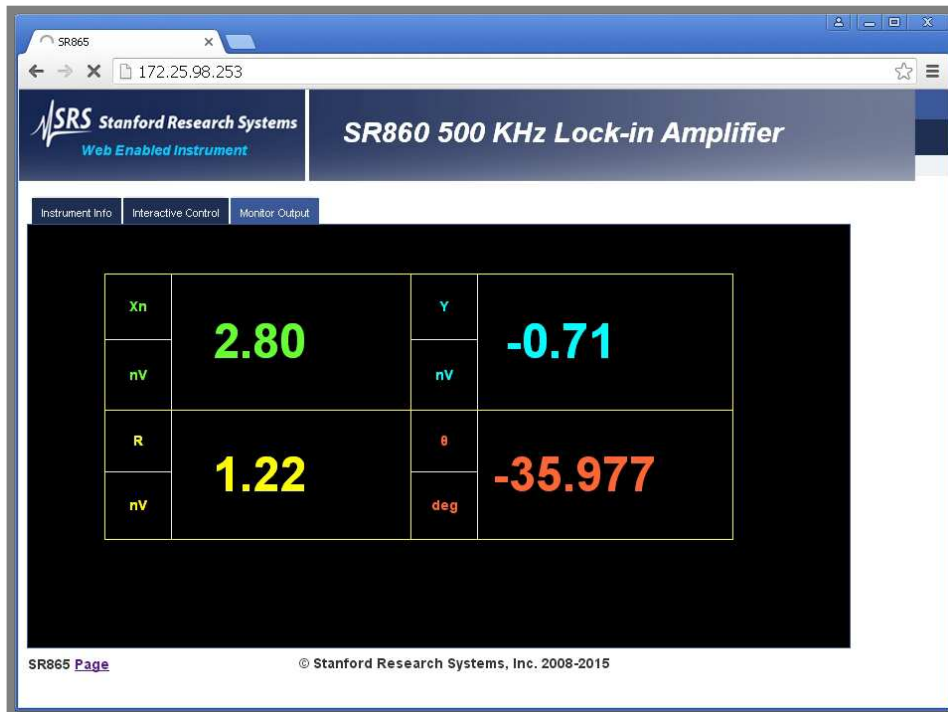

Appendix D

Data Streaming and Capture

Example source code for ethernet data streaming (in Python and C++) can be found under the “Programs” tab of the SR860 product page. The SR860 product page is at <http://thinkSRS.com/products/SR860.htm>

Ethernet streaming of lock-in data (X, Y, R, and θ) is implemented using UDP packets. The STREAM ON command must be sent via VXI-11 from the computer that will receive the streamed data. This is because ethernet streaming sends data to the IP address that sent the STREAM ON command.

UDP packets must be received on a “port,” which is a virtual numerical address on the receiving computer. Common ports, like 80 for web servers or 22 for ssh, should be avoided. By default, port 1865 is used, but that can be changed with the STREAMPORT command.

Note: Many computer systems will block SR860 streaming by default. Users will typically need to open the network port number (1865 by default) to incoming UDP traffic on their personal firewall software.

All data in the UDP packet are binary, so the “endianness” of the data matters. In big-endian format, a 32-bit (4-byte) word is stored as B3 B2 B1 B0, where B3 is the most-significant byte of the word and B0 is the least significant byte. Little-endian format reverses the byte order, so that the same 32-bit (4-byte) word is stored as B0 B1 B2 B3. Similarly, a 16-bit (2-byte) integer is stored as B1 B0 in big-endian format, while it is B0 B1 in little-endian format. If the streamed data is not in the same endianness as the receiving computer, then the byte order of the data must be reversed. Note that the bits within each byte are NOT reversed.

Each UDP packet sent consists of a 32-bit (4-byte) header, and 128-1024 bytes of data, as shown below. The endianness of the data and packet integrity-checking are controlled by the STREAMOPTION command. If integrity-checking is enabled, it is handled automatically by Ethernet hardware; if an error is detected, then the entire packet is dropped. The amount of data sent in each packet is controlled by the STREAMPCKT command. You might want to send fewer data bytes per packet if the sample rate is low and you want packets to arrive with less latency. Otherwise, larger data sizes are recommended as they have less overhead and are more bandwidth-efficient.

Header	Data
4 bytes	128-1024 bytes
Big-endian	Big- or little-endian

The header word consists of the following fields:

Header bits				
31–24 (MSB)	23–16	15–12	11–8	7–0 (LSB)
Status	Sample rate	Packet length	Packet content	Packet counter
Bit 24: Overload	0: 1.25 MHz	0: 1024 bytes	32 bit floats:	0–255
Bit 25: Error	1: 625 kHz	1: 512 bytes	0: X	
Bit 28: Little-end	2: 312.5 kHz	2: 256 bytes	1: XY	
Bit 29:Checksum	...	3: 128 bytes	2: R0	
	N: $1.25\text{MHz}/2^N$,		3: XYR0	
	...		16 bit integers:	
	31: 0.582 mHz		4: X	
			5: XY	
			6: R0	
			7: XYR0	

Packet counter: allows the receiving computer to detect lost or dropped packets. Each UDP packet has a packet count that is one greater than the previous packet, modulo 256.

Packet content: indicates the data contained in the packet.

Packet length: the number of bytes of data that follow.

Sample rate: is the sample rate of the data in the packet. A value of N corresponds to a sampling rate of $1.25\text{ MHz}/(2^N)$, where N is a value between 0 and 31 inclusive. This sample rate already takes into account the subsampling requested in the command STREAMRATE.

Status: bit 24 is high when an input overload, sync filter overload (if sync filter is on), or output overload (if integer data is contained in the packet) condition existed at the beginning of the packet. Bit 25 is high when a PLL unlock or sync filter out-of-range condition existed at the beginning of the packet.

Bit 28 is high if data is stored in little-endian format, and low if it is in big-endian format. Bit 29 indicates that integrity-checking (UDP packet checksumming) is enabled.

After reading the header information, it is possible to correctly interpret the data in the rest of the packet. If you need to do endian-conversion, floating-point data must be converted 32 bits (4 bytes) at a time, whereas integer data must be converted 16 bits (2 bytes) at a time.

XYR0 data is recorded in that order, followed by the next sample of XYR0. As an example, let's say the packet contains floating-point XYR0 data:

Data bytes																					
Byte	0	1	2	3	4	5	6	7	8	9	10	11	12	13	14	15	16	17	18	19	...
Data	X(0)				Y(0)				R(0)				0(0)				X(1)				...

If the packet contains integer XY data:

Data bytes																					
Byte	0	1	2	3	4	5	6	7	8	9	10	11	12	13	14	15	16	17	18	19	...
Data	X(0)		Y(0)		X(1)		Y(1)		X(2)		Y(2)		X(3)		Y(3)		X(4)		Y(4)		...

The maximum sample rate is 1.25MHz. If floating-point XYRθ data is streamed, then the data rate can exceed $1.25 \text{ MHz} \times 4 \text{ channels} \times 4 \text{ bytes} = 20 \text{ MBytes/s}$. This data rate requires Gigabit ethernet to work. Fast (100Mb/s) ethernet is not sufficient to support the maximum data rate. At high data rates, we recommend putting the SR860 and the receiving computer on the same dedicated network. This reduces traffic congestion for other users, and reduces the chance of dropped packets.

Appendix E

Dual Reference Detection

In a typical lock-in experiment the signal of interest is at a known frequency ω_{sig} . The lock-in is set up to detect signals at only this frequency by multiplying the input signal by $\sin(\omega_{\text{sig}}t)$ (using either internal or external reference mode).

If the signal is

$$A_{\text{sig}} \sin(\omega_{\text{sig}}t)$$

then the result of the lock-in multiplication is

$$A_{\text{sig}} \sin(\omega_{\text{sig}}t) \times \sin(\omega_{\text{sig}}t) = \frac{A_{\text{sig}}}{2} [1 - \cos(2\omega_{\text{sig}}t)]$$

and the time constant low pass filter removes the $2\omega_{\text{sig}}$ component leaving a dc result proportional to A_{sig} .

In some experiments there is an additional modulation of the signal. This results from the mixing of 2 frequencies in the experiment. Often one of the frequencies is much lower than the other. Let's call these frequencies ω_{car} and ω_{mod} for carrier and modulation and assume $\omega_{\text{mod}} \ll \omega_{\text{car}}$.

If the carrier signal is

$$A_{\text{car}} \sin(\omega_{\text{car}}t),$$

then the experiment modulates this by multiplying by the modulation signal resulting in

$$A_{\text{car}} \sin(\omega_{\text{car}}t) \times A_{\text{mod}} \sin(\omega_{\text{mod}}t) = \frac{A_{\text{car}}A_{\text{mod}}}{2} [\cos(\{\omega_{\text{car}} - \omega_{\text{mod}}\}t) - \cos(\{\omega_{\text{car}} + \omega_{\text{mod}}\}t)]$$

The experimental signal consists of equal amplitude components at the sum and difference frequencies.

Two Lock-in Detection

This signal can be measured using 2 lock-in amplifiers. The signal is input to the first lock-in which is set to detect at ω_{car} . The output of this lock-in will contain sum and difference components from both signal components. One of these will be

$$\frac{A_{\text{car}} A_{\text{mod}}}{4} [2 \sin(\{\omega_{\text{car}} + \omega_{\text{mod}} - \omega_{\text{car}}\}t)] = \frac{A_{\text{car}} A_{\text{mod}}}{2} \sin(\omega_{\text{mod}}t)$$

The time constant is adjusted to remove the high frequency sum components at $2\omega_{\text{car}}$ and the analog output of this first lock-in is the signal input to the second lock-in. The second lock-in is set to detect at ω_{mod} . The X output of this second lock-in is

$$\frac{A_{\text{car}} A_{\text{mod}}}{2} \sin(\omega_{\text{mod}}t) \times \sin(\omega_{\text{mod}}t) = \frac{A_{\text{car}} A_{\text{mod}}}{4} [1 - \cos(2\omega_{\text{mod}}t)]$$

The second lock-in time constant is adjusted to remove the $2\omega_{\text{mod}}$ component leaving a dc signal proportional to $A_{\text{car}}A_{\text{mod}}$ as desired.

SR860 Dual Reference Mode

The SR860 Dual Reference mode makes this measurement in a single lock-in. One of the frequencies is the external reference and the other is the internal reference. In Dual Reference mode, the SR860 detects at $|\omega_{\text{ext}} - \omega_{\text{int}}|$, i.e. the difference frequency. It doesn't matter which is the carrier and which is the modulation. It also doesn't matter which frequency is greater or by how much. The detection frequency is the difference between the two frequencies and will always be lower than the greater frequency.

The original signal contains components at the sum and difference frequencies

$$\frac{A_{\text{car}} A_{\text{mod}}}{2} [\cos(\{\omega_{\text{car}} - \omega_{\text{mod}}\}t) - \cos(\{\omega_{\text{car}} + \omega_{\text{mod}}\}t)]$$

In Dual Reference mode, the SR860 multiplies² by $\cos(\{\omega_{\text{car}} - \omega_{\text{mod}}\}t)$, giving the Y output

$$\frac{A_{\text{car}} A_{\text{mod}}}{4} [1 + \cos(2\{\omega_{\text{car}} - \omega_{\text{mod}}\}t) - \cos(2\omega_{\text{car}}t) - \cos(2\omega_{\text{mod}}t)]$$

The SR860 time constant is adjusted to remove all components at $2|\omega_{\text{car}} - \omega_{\text{mod}}|$, $2\omega_{\text{car}}$ and $2\omega_{\text{mod}}$ leaving a dc signal proportional to $A_{\text{car}}A_{\text{mod}}$ as desired. It should be noted the lock-in reports the measured amplitude at $(\omega_{\text{car}} - \omega_{\text{mod}})$, which is $(A_{\text{car}}A_{\text{mod}})/2$. Correcting for rms, the displayed result will be $(A_{\text{car}}A_{\text{mod}})/(2\sqrt{2})$.

The Dual Reference mode in the SR860 does not care about the "order" of ω_{ext} and ω_{int} . The experimental signal could be a fast modulation of a slow carrier or vice versa. The SR860 does not require that one of the frequencies be much greater than the other. The two frequencies can be very close together. The only requirement is that the time constant remove all output components other than dc.

The SR860 does require that one of the frequencies be the internal reference and the other the external reference and the difference between them must be less than 500 kHz.

² In dual mode, an in-phase signal is detected at $+90^\circ$ phase; hence the $\cos(\{\omega_{\text{car}} - \omega_{\text{mod}}\}t)$ rather than $\sin()$.

Appendix F

Fuse Installation and ac Line Select

The SR860 operates from 100 V, 120 V, 220 V, or 240 V nominal ac power source having a line frequency of 50 or 60 Hz, and accommodates both North American single-fuse or metric dual-fuse operation. This appendix provides detailed instructions for modifying the input voltage selection and replacing the line fuse.

Power Entry Module

The line cord receptacle, power switch, fuse holder, and line voltage selector are all part of the “power entry module” located on the rear panel of the SR860. Detailed instructions for changing the line voltage selection and fuse replacement follow.

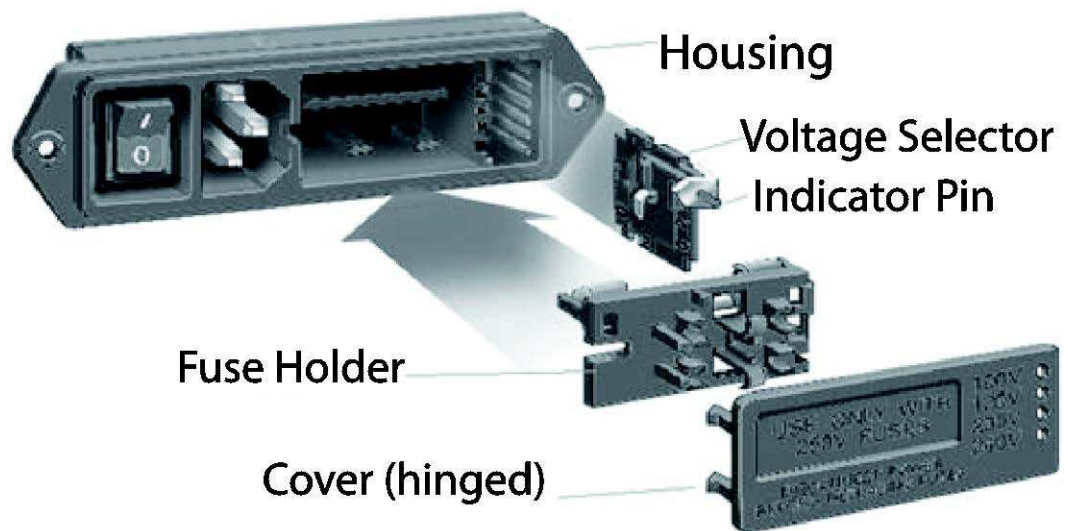

ac Voltage Selector

The SR860 line voltage selection is indicated by the white pin visible at the right hand edge of the power entry module. In the image below, the line voltage selection is showing 120 V. Note that on some units (as pictured below), the 220 V selection can be labeled 230 V; that position is appropriate for both 220 V and 230 V nominal ac line voltages.



The following steps describe how to change the line voltage selection:

1. Disconnect and remove the power cord.
2. Open the fuse cover (see instructions, below, for fuse installation for detailed illustrations).
3. Pull the voltage selector card straight out of the housing, using small needle-nose pliers to grip the plastic indicator pin body.
4. Orient the selector card so that the desired line voltage is readable at the bottom

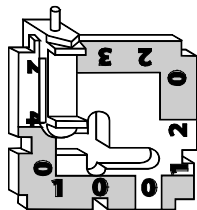

100V

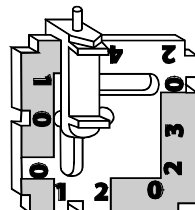

120V

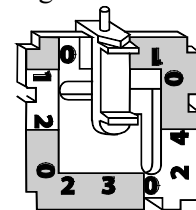

230V (& 220V)

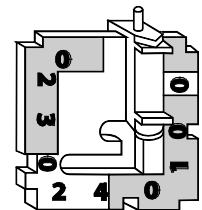

240V

5. Orient indicator pin to point up when desired line voltage is readable at the bottom (note that when indicator pin is fixed, successive voltages are selected by rotating the card 90° clockwise)
6. Insert the voltage selector card into housing, with the printed side of the card facing the fuse and IEC connector. Orient the card so the text showing the desired voltage is inserted first.
7. Replace the fuse cover and snap into position, verifying the indicator pin is showing at the desired line voltage.
8. If necessary, replace the fuse for the appropriate rating based on line voltage.

Fuse Installation

Two options are available for fusing the SR860—North American style single fuse, and metric dual fuse installation. The fuse holder is reversible to accommodate both styles.

The following steps describe how to install or replace the fuse(s):

1. Disconnect and remove the power cord.

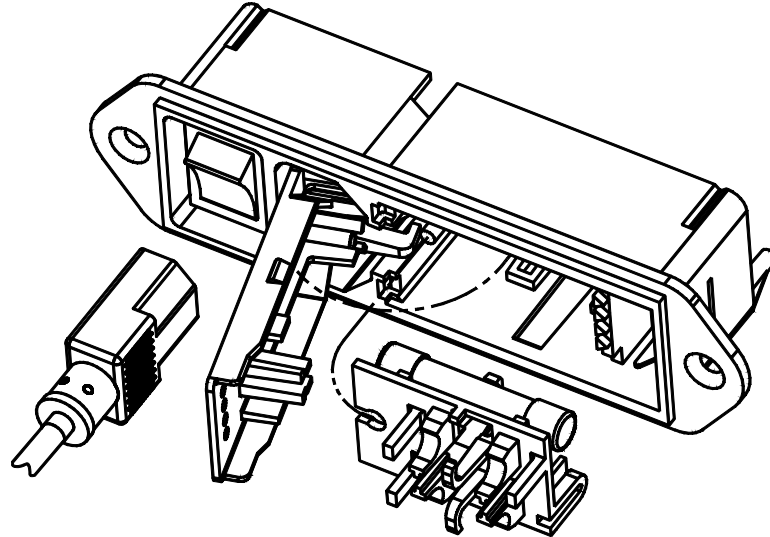

2. Insert a small screwdriver at the point "X" as shown

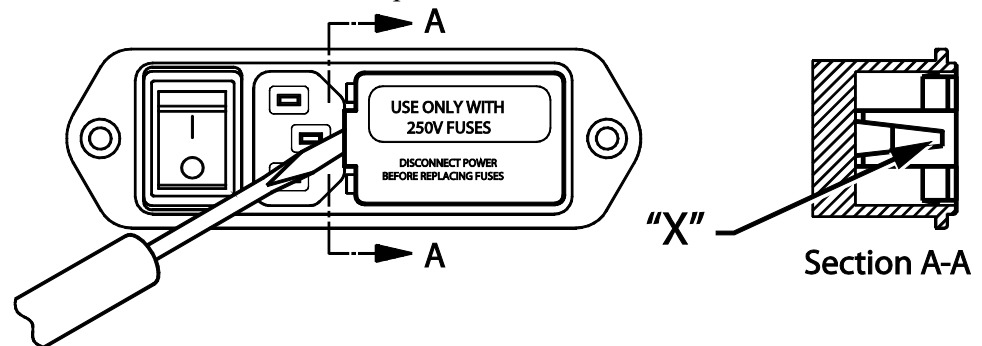

3. Gently lift the entire door back, away from the rear panel of the SR860. Lift away approximately 0.25" (6 mm). Once lifted, the door will pivot on its hinges to expose the fuse holder.

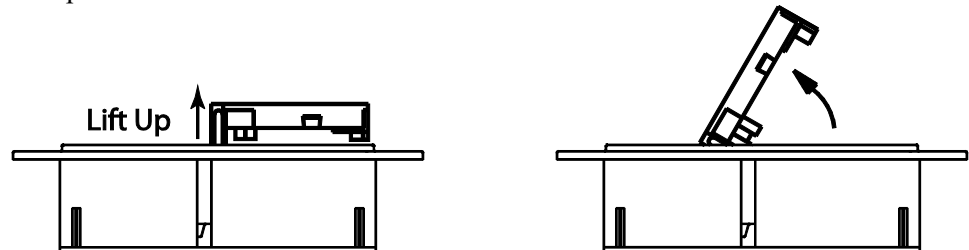

4. When the fuse holder is installed in the single fuse (North American) position, apply a screwdriver or small needle nose pliers as shown and gently lift out. Use a tool as shown, do not use fingers.

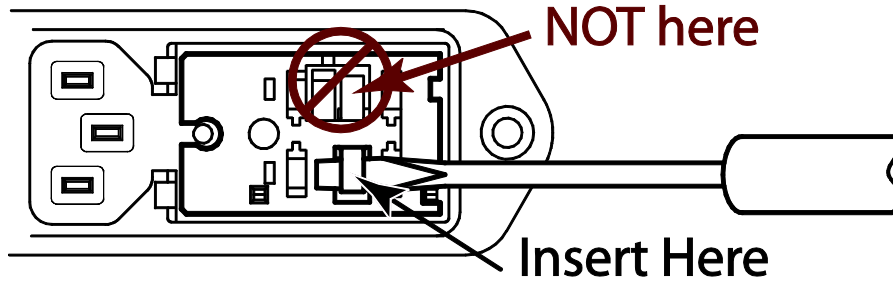

When the fuse holder is installed in the dual (metric) position, it will normally release as soon as the door is opened.

5. Install one (1) AG size $0.25\frac{1}{8} \times 1.25\frac{1}{8}$ fuse or two (2) metric size 5×20 mm fuses as shown. *Install fuses on one side only—do not install both AG and metric together at the same time.*

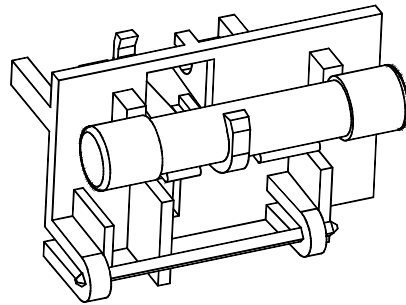

**North American
single fuse installation**

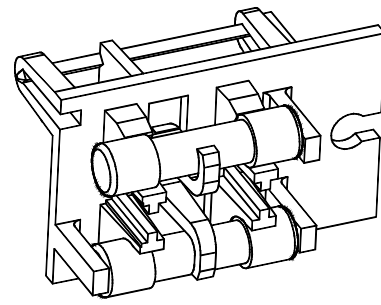

**Metric
dual fuse installation**

Also note that, when installing the North American AG fuse, the fuse is not centered on the plastic retaining hook, but rather shifted towards the right-hand side (see image, above left). If the fuse is not properly aligned, the fuse holder will not seat properly and line voltage will not be provided to the instrument.

6. Replace fuse holder into housing, fuse first. Be sure to align the circular alignment opening on the fuse holder with the orienting pin within the power entry module.

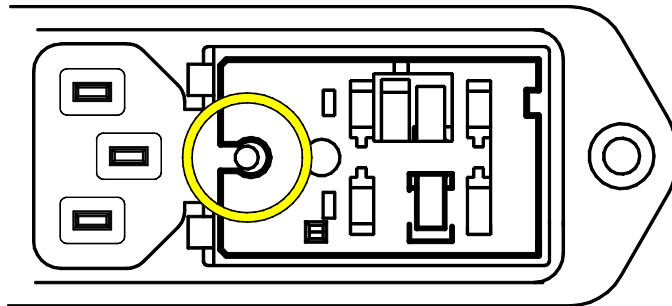

7. Swing and push to snap the door back in place.

Appendix G

Performance Tests

Introduction

The performance tests described in this section are designed to verify with a high degree of confidence that the unit is performing correctly.

The results of each test may be recorded on the test sheet at the end of this section.

Serial Number and Firmware Revision

If you need to contact Stanford Research Systems, please have the serial number of your unit available. The 6-digit serial number is printed on a label affixed to the rear panel.

Press and hold [Local] and then [Auto Range] at the same time to display the unit serial number and version numbers. The [Screen Layout] key exits this screen.

Preset

Throughout this section, it will be necessary to preset the lock-in into a known default state. To do this, press [Save Recall], then touch {Recall default}. Touch {Confirm} to reset the SR860 to its default settings. Each test generally starts with a preset. This procedure will be referred to as {PRESET}.

Front Panel Test

To test the front panel, press and hold [Local] and then [Auto Range] at the same time.

Turn any knob to run through all of the LEDs. Make sure all of the knobs and all of the LEDs work.

Touch and drag on the touchscreen to display a little trail. The bright end signifies the lift location. This verifies the touch functionality.

Press each key to toggle its position (green/gray) on the screen. Keys with a second press and hold function need to be held to toggle. The knobs also have a press and hold feature. Check to see that all keys and knobs function.

The [Screen Layout] key exits this screen.

Keys, Knobs and Touch Buttons

These test procedures require the unit to be adjusted from the front panel. The test procedures will follow this convention:

[Key]	Front panel keys are referred to in [square] brackets. Some keys have a second italicized label. Press and hold these keys for 2 seconds to invoke the italicized function.
<Knob>	Knobs are referred to in <angle> brackets. Knobs are used to adjust parameters which have a wide range of values. Some knobs have a push button function. Some also have a second italicized label. Press and hold these knobs for 2 seconds to invoke the italicized function.
{Touch}	Touchscreen buttons and icons are referred to in {curly} brackets. Touchscreen buttons are used to adjust the data display as well as change certain lock-in parameters.

Warm Up

The lock-in should be turned on and allowed to warm up for at least an hour before any tests are performed. It is necessary to turn the unit off and on to preset it. As long as the unit is powered on immediately, this will not affect the test results.

Necessary Equipment

The following equipment is necessary to complete the performance tests. The suggested equipment or its equivalent should be used.

1. Frequency Synthesizer

Freq Range	1 Hz to 500 kHz
Freq Accuracy	better than 5 ppm
Harmonic Distortion	≤ -65 dBc
Spurious	≤ -55 dBc
TTL SYNC	available

2. AC Voltmeter

Freq Range	10 Hz to 500 kHz
Input Ranges	10 mV, 100 mV, 1 V
Accuracy	0.5% below 200 kHz, 2% below 500 kHz
Suggested instrument	Keysight model 3458A

3. DC Voltmeter

Range	19.999 V, 4 1/2 digits
Accuracy	0.005%

4. Feedthrough Terminations

Impedance	50 Ω , precision to $\pm 0.1\%$
-----------	--

Test Record

Make a copy of the SR860 Performance Test Record at the end of this section. Fill in the results of the tests on this record. This record will allow you to determine whether the tests pass or fail and also to preserve a record of the tests.

If A Test Fails

If a test fails, you should check the settings and connections of any external equipment and, if possible, verify its operation using a DVM, scope or some other piece of test equipment.

After checking the setup, repeat the test from the beginning to make sure that the test was performed correctly.

If the test continues to fail, contact Stanford Research Systems for further instructions. Make sure that you have the unit's serial number and firmware revision code handy. Have the test record on hand as well.

dc Offset

This test measures the dc offset of the signal input.

Setup

Connect a 50 Ω terminator to the A input. This shorts the input so the lock-in's own dc offset will be measured.

Procedure

- 1) {PRESET} (press [Save Recall], then touch {Recall default}. Touch {Confirm})
- 2) Use the front panel to make the following adjustments
 - Touch {Fint} to display the internal frequency keypad
Enter a frequency of 1.00 Hz.
 - Press [Input Range Down] multiple times
Set the input range to 10 mV.
 - Press [Sensitivity Down] multiple times
Set the sensitivity to 10 mV.
- 3) Wait at least 10 seconds, then record the reading of R (yellow).
- 4) Use the front panel to make the following adjustments
 - Press [Couple]
Select DC coupling.
- 5) Wait 10 seconds, then record the reading of R (yellow).
- 6) This completes the dc offset test. Enter the results of this test in the test record at the end of this section.

Common Mode Rejection

This test measures the common mode rejection of the voltage input.

Setup

We will use the internal oscillator sine output to provide the signal.

Connect the Sine Out+ to both the A and B inputs of the lock-in. Use equal length cables from A and B to a BNC TEE. Connect the cable from the Sine Out+ to the TEE. This test only uses ONE Sine Out BNC. Do not use any termination.

Procedure

- 1) {PRESET} (press [Save Recall], then touch {Recall default}. Touch {Confirm})
- 2) Use the front panel to make the following adjustments
 - Touch {Fint} to display the internal frequency keypad
Enter a frequency of 1.0 kHz.
 - Touch {Ampl} to display the sine out amplitude keypad
Enter an amplitude of 1.0 V.
- 3) The value of R (yellow) should be 1.000 V (within 2%).
- 4) Use the front panel to make the following adjustments
 - Press [Couple]
Select DC coupling.
 - Press [A-B]
Select A-B.
 - Press [Input Range Down] two times
Set the input range to 100 mV.
 - Press [Sensitivity Down] multiple times
Set the sensitivity to 200 μ V.
- 5) Record the value of R (yellow).
- 6) This completes the CMRR measurement test. The common mode rejection is $20\log(1.0/R)$ where R is in Volts. Enter the results of this test in the test record at the end of this section.

Sine Output Amplitude Accuracy and Flatness

This test measures the amplitude accuracy and frequency flatness of the internal oscillator Sine Out. These results will also be used next for testing the input Amplitude Accuracy.

Setup

We will use the precision ac multimeter to measure the Sine Out. Connect the Sine Out+ to the ac Volts input of the voltmeter using a 1 meter BNC cable, with the precision 50 Ω terminator at the voltmeter connection. This test only uses ONE Sine Out BNC. This means that each measurement with the ac voltmeter will nominally be 50% of the programmed sine amplitude.

Set the multimeter for ac volts. If using the model 3458A, it should be configured as:

- i) Reset: press (blue shift key) then Reset
- ii) SETACV RNDM: press (blue) “S”, then \Downarrow 3 times, then \Rightarrow , then \Downarrow 2 times, then Enter
- iii) ACV: press ACV
- iv-a) for RANGE 1: press (blue) “R”, then “1”, then Enter
- iv-b) for RANGE 0.1: press (blue) “R”, then “0.1”, then Enter
- iv-c) for RANGE 0.01: press (blue) “R”, then “0.01”, then Enter

Procedure

- 1) {PRESET} (press [Save Recall], then touch {Recall default}. Touch {Confirm})
- 2) Amplitude accuracy is verified at 1 kHz. Use the front panel to make the following adjustments
 - Touch {Fint} to display the internal frequency keypad
 - Enter a frequency of 1.0 kHz.
- 3) For each sine amplitude, use the voltmeter range setting in the table below, perform steps 3a through 3b.

<u>Sine Output Amplitude</u>	<u>ac voltmeter range</u>
1.00 V	1
300 mV	1
100 mV	0.1
30 mV	0.1
10.0 mV	0.01
1.00 mV	0.01

- a) Use the SR860 front panel to make the following adjustments

- Touch {Ampl} to display the sine out amplitude keypad
- Enter the amplitude from the table.

- b) Adjust the voltmeter range (step iv-a, iv-b, or iv-c). Wait for the ac volts reading to stabilize. Record the value.
- c) Repeat 3a and 3b for each amplitude in the table.
- 4) Adjust the multimeter range to 100 mVAC (step iv-b)
- 5) Use the front panel to make the following adjustments

Touch {Ampl} to display the sine out amplitude keypad
Enter an amplitude of 100 mV.

- 6) Frequency response is checked at frequencies above 1 kHz. The sine amplitude is set to 100 mV for all frequencies. The test frequencies are listed below.

Test Frequencies

10 kHz
100 kHz
500 kHz

- a) Use the front panel to make the following adjustments

Touch {Fint} to display the internal frequency keypad
Enter the frequency from the table.
- b) Wait for the multimeter readings to stabilize. Record the value.
- c) Repeat steps 6a and 6b for all frequencies in the table.
- 7) This completes the sine output amplitude accuracy and frequency response test. Enter the results of this test in the test record at the end of this section.

Amplitude Accuracy and Flatness

This test measures the amplitude accuracy and frequency response.

Setup

We will use the internal sine output to provide an accurate sine wave for testing the signal input function. This test requires the preceding Sine Output Amplitude Accuracy and Flatness test results to verify specified performance.

Connect the Sine Out+ to the Voltage A input of the SR860 using a 1 meter BNC cable, with the precision 50Ω terminator at the A input BNC. This test only uses ONE Sine Out BNC. This means that each measurement will nominally be 50% of the programmed sine amplitude.

Preliminary calculations

- i) Refer to the Reading values recorded for the Sine Output Amplitude and Flatness test.
- ii) Results labeled (A) through (J) are used to set performance Lower Limits and Upper Limits for Amplitude Accuracy and Flatness
- iii) On the Performance Test Record, for Lower and Upper limits, perform the multiplication indicated with the referenced value of Sine Output Amplitude and Flatness. For example:
Assume result (A) is recorded as 0.4966 V
 The Lower Limit at 1V will be $0.99 \times (A) = 0.99 \times 0.4966 \text{ V} = 0.4916 \text{ V}$
 The Upper Limit at 1V will be $1.01 \times (A) = 1.01 \times 0.4966 \text{ V} = 0.5016 \text{ V}$

Procedure

- 1) {PRESET} (press [Save Recall], then touch {Recall default}. Touch {Confirm})
- 2) Use the front panel to make the following adjustments
 - Touch {Fint} to display the internal frequency keypad
Enter a frequency of 1.0 kHz.
 - Press Filter [Slope/adv] multiple times
Select 24 dB/oct.
- 3) Amplitude accuracy is verified at 1 kHz and various sensitivities. For each input range setting in the table below, perform steps 3a through 3c.

<u>Sine Out Amplitude</u>	<u>Input Range</u>	<u>Sensitivity</u>
1.0000 Vrms	1 V	1 V
300.00 mVrms	300 mV	200 mV
100.000 mVrms	100 mV	100 mV
30.000 mVrms	30 mV	50 mV
10.000 mVrms	10 mV	10 mV

- a) Use the front panel to make the following adjustments

Touch {Ampl} to display the amplitude keypad
Enter the amplitude from the table

Press [Input Range Down]
Select the input range from the table.

Press [Sensitivity Down]
Select the sensitivity from the table.

- b) Wait for the R reading to stabilize. Record the value of R (yellow) for each sensitivity.

- 4) Frequency response is checked at frequencies above 1 kHz. The test frequencies are listed below.

Test Frequencies

1.0 kHz
10 kHz
100 kHz
500 kHz

- a) Use the front panel to make the following adjustments

Touch {Ampl} to display the amplitude keypad
Enter the 100 mV

Press [Input Range Up/Down]
Set the input range to 100 mV.

Press [Sensitivity Up/Down]
Set the sensitivity to 100 mV.

- b) Set the sine output to the frequency in the table.

Touch {Fint} to display the internal frequency keypad
Enter the frequency from the table.

- c) Wait for the R reading to stabilize. Record the value of R (yellow).

- d) Repeat steps 4b and 4c for all of the frequencies listed.

- 5) This completes the amplitude accuracy and frequency response test. Enter the results of this test in the test record at the end of this section.

Amplitude Linearity

This test measures the amplitude linearity. This tests how accurately the lock-in measures a signal smaller than full scale. This test requires the preceding Sine Output Amplitude Accuracy and Flatness test results to verify specified performance.

Setup

We will use the internal sine output to provide an accurate sine wave for testing the signal input function. This test requires the preceding Sine Output Amplitude Accuracy and Flatness test results to verify specified performance.

Connect the Sine Out+ to the Voltage A input of the SR860 using a 1 meter BNC cable, with the precision 50Ω terminator at the A input BNC. This test only uses ONE Sine Out BNC. This means that each measurement will nominally be 50% of the programmed sine amplitude.

Procedure

- 1) {PRESET} (press [Save Recall], then touch {Recall default}. Touch {Confirm})
- 2) Use the front panel to make the following adjustments

Touch {Fint} to display the internal frequency keypad
Enter a frequency of 1.0 kHz.

Press Filter [Slope/adv] multiple times
Select 24 dB/oct.

- 3) For each of the amplitudes listed below, perform steps 3a through 3b.

<u>Sine Out Amplitude</u>	<u>Sensitivity</u>
1.0000 Vrms	1 V
100.000 mVrms	100 mV
10.000 mVrms	10 mV
1.000 mVrms	1 mV

- a) Use the front panel to make the following adjustments

Touch {Ampl} to display the amplitude keypad
Enter the amplitude from the table

Press [Sensitivity Down]
Select the sensitivity from the table.

- b) Wait for the R reading to stabilize. Record the value of R.

- 4) This completes the amplitude linearity test. Enter the results of this test in the test record at the end of this section.

Frequency Accuracy

This test measures the frequency accuracy of the lock-in. This tests the accuracy of the frequency counter inside the unit. The counter is used only in external reference mode. The internal oscillator frequency is set by a crystal and has 25 ppm frequency accuracy.

Setup

We will use the frequency synthesizer to provide the reference signal.

Connect the TTL SYNC output of the frequency synthesizer to the Reference input of the lock-in.

Procedure

- 1) {PRESET} (press [Save Recall], then touch {Recall default}. Touch {Confirm})
- 2) Set the frequency synthesizer to a frequency of 9.9990 kHz.
- 3) Use the front panel to make the following adjustments

Press [Ref/chop]
Select External reference mode.



Press External [Trig]
Select Pos TTL.

Press [Config]
Touch {Data1 Display} to highlight the green data source.
Touch {Fext} to choose external reference frequency for Data1.
Touch {Close}

Press [Screen Layout] multiple times to set the screen to show half-screen strip chart

Touch the green vertical tile for Fe, and touch autoscale  to expand the trace.

Touch the white horizontal scale tile {Time} to display the horizontal scale palette,
and touch  repeatedly to zoom out to 10 s/div.

Touch {Cursor MinMaxMean} to set the cursor mode ;
and touch {Cursor Width} to select wide mode .

- 4) The lock-in should be locked to the external reference. Wait at least 45 seconds locked to the external synthesizer. Then touch {Pause} , and move the cursor to 30 seconds from the right-hand end of the chart. Record the average value of Fe (external frequency) from the cursor display.
- 5) This completes the frequency accuracy test. Enter the results of this test in the test record at the end of this section.

Phase Accuracy

This test measures the phase accuracy of the lock-in. The phase accuracy is determined by measuring the phase of the internal oscillator Sine Out.

Setup

Connect the Sine Out+ to the Voltage A input of the SR860 using a 24-inch BNC cable, with the precision 50 Ω feedthrough terminator at the A input BNC. This test only uses ONE Sine Out BNC.

Please note that the phase calibration is performed at the factory relative to a 24-inch RG-58 BNC cable, with approximately 3 ns of propagation delay. Results will be show a significant dependence on cable length. For example, using a 2 m long cable instead of the specified 24-inch cable will introduce an additional 6.9 ns of propagation delay between sine output and signal input: at 500 kHz, this corresponds to 1.25° of additional phase delay.

Procedure

- 1) {PRESET} (press [Save Recall], then touch {Recall default}. Touch {Confirm})
- 2) Use the front panel to make the following adjustments
 - Touch {Fint} to display the internal frequency keypad
Enter a frequency of 1.0 kHz.
 - Touch {Ampl} to display the sine out amplitude keypad
Enter an amplitude of 100 mV.
 - Press Filter [Slope/adv] multiple times
Select 24 dB/oct.
 - Press [Time Constant Up]
Select 300 ms
 - Press [Input Range Down]
Select 300 mV
 - Press [Couple]
Select DC coupling.
- 3) The value of R (yellow) should be 0.050 V ($\pm 2\%$) and the value of θ (orange) should 0° ($\pm 1^\circ$).
- 4) Phase accuracy is checked at various frequencies. The test frequencies are listed below.

Test Frequencies

10 Hz
100 Hz
1 kHz
10 kHz
100 kHz
500 kHz

- a) Use the front panel to make the following adjustments
 - Touch {Fint} to display the internal frequency keypad
 - Enter the frequency from the table.
 - b) Wait for the readings to stabilize. Record the value of θ (orange).
 - c) Repeat steps 4a and 4b for all frequencies in the table.
- 5) This completes the phase accuracy test. Enter the results of this test in the test record at the end of this section.

dc Outputs and Inputs

This test measures the dc accuracy of the dc outputs and inputs of the lock-in.

Setup

We will use the digital voltmeter (DVM) to measure the dc outputs of the lock-in. Then we will use one of the outputs to generate a voltage to measure on the dc inputs.

Connect a 50 Ω termination to the A input.

Procedure

- 1) {PRESET} (press [Save Recall], then touch {Recall default}. Touch {Confirm})

Press [Screen Layout] multiple times if needed

Set the screen to show 8 big numerical/bar graphs.

- 2) For the CH1 and CH2 outputs, repeat steps 2a through 2e.

- a) Connect the CH1 (or CH2) output to the DVM. Set the DVM to a 20 V range.

- b) Use the front panel to make the following adjustments

Press the CH1 (or CH2) Output <Offset> knob

Turn the offset on. Make sure the **OFFSET** LED is on.

Press and hold the CH1 (or CH2) Output <Offset> knob

Display the X (or Y) offset keypad.

- c) For each of the offsets in the table below, repeat steps 2d and 2e.

Offsets (%)

-100.00

-50.00

0.00

50.00

100.00

- d) Use the front panel to make the following adjustments

Turn the CH1 (or CH2) Output <Offset> knob to set the offset to the value in the table.

- e) Record the DVM reading.

- 3) For each Aux Output (1, 2, 3 and 4), repeat steps 3a through 3e.

- a) Connect the Aux Output (on the rear panel) to the DVM.

- b) Use the front panel to make the following adjustments

Press [Aux Output] to display the Aux Output keypad
Touch an {Out} button to display the correct Aux Output in the keypad.

- c) For each output voltage in the table below, repeat steps 3d and 3e.

Output Voltages

-10.000
-5.000
0.000
5.000
10.000

- d) Use the keypad to enter the Aux Output level from the table.
e) Record the DVM reading.

- 4) Use the front panel to make the following adjustments

Press [Aux Output] to display the Aux Output keypad
Touch {Out1} button to display Aux Output 1 in the keypad.

Press [Screen Layout] multiple times
Set the screen to show 8 big numerical/bar graphs.

Press [Config]
Touch {Data1 Display} to highlight the green data source.
Touch {In 1} to choose Aux input 1 for Data1.
Repeat this to assign In2 – In4 to Data2 – Data4.

- 5) For Aux Inputs (1, 2, 3 and 4), repeat steps 5a through 5e.

- a) Connect Aux Out 1 to the Aux Input under test with a BNC cable.
b) For each output voltage in table 3c above, repeat steps 5c and 5d.
c) Use the front panel to make the following adjustments

Press [Aux Output] to display the Aux Output keypad
Use the keypad to enter the Aux Output 1 level from the table.

- d) Record the Aux Input (1, 2, 3 or 4) value.
6) This completes the dc outputs and inputs test. Enter the results of this test in the test record at the end of this section.

Input Noise

This test measures the lock-in input noise.

Setup

Connect a 50 Ω termination to the A input. This grounds the input so the lock-in's own noise is measured.

Procedure

- 1) {PRESET} (press [Save Recall], then touch {Recall default}. Touch {Confirm})
- 2) Use the front panel to make the following adjustments
 - Touch {Fint} to display the internal frequency keypad
Enter a frequency of 1.0 kHz.
 - Press [Input Range Down] multiple times
Set the input range to 10 mV.
 - Press [Sensitivity Down] multiple times
Set the sensitivity to 100 nV.
 - Press Filter [Slope/adv]
Select 12 dB/oct.
 - Press [Couple]
Select DC coupling.
 - Press [Ground]
Select shield Ground .
 - Press [Config] to display the data configuration screen
Touch {Data1 Display} to highlight the green data source.
Touch {Xnoise} to choose Xnoise for Data1.
Touch {Close}
- 3) Wait at least 1 minute for the reading of Xnoise (green) to stabilize. Record the value of Xnoise.
- 4) This completes the noise test. Enter the results of this test in the test record at the end of this section.

SR860 Performance Test Record

Serial Number _____ Tested By _____

Firmware Revision _____ Date _____

Equipment Used _____

dc Offset

<u>Input Coupling</u>	<u>Reading</u>	<u>Upper Limit</u>
AC	_____	0.500 mV
DC	_____	0.500 mV

Common Mode Rejection

<u>Frequency</u>	<u>Reading</u>	<u>Upper Limit</u>
1 kHz	_____	30 μ V

Sine Output Amplitude and Flatness

<u>Sine Output Ampl.</u>	<u>Lower Limit</u>	<u>Reading</u>	<u>Upper Limit</u>
1.00 V	0.490 V	(A)_____	0.5100 V
300 mV	147.0 mV	(B)_____	153.0 mV
100 mV	49.0 mV	(C)_____	51.0 mV
30 mV	14.70 mV	(D)_____	15.30 mV
10.0 mV	4.98 mV	(E)_____	5.10 mV
1.00 mV	0.490 mV	(F)_____	0.510 mV

<u>Sine Ampl.</u>	<u>Frequency</u>	<u>Lower Limit</u>	<u>Reading</u>	<u>Upper Limit</u>
100 mV	10 kHz	49.0 mV	(G)_____	51.0 mV
	100 kHz	49.0 mV	(H)_____	51.0 mV
	500 kHz	49.0 mV	(J)_____	51.0 mV

Note the readings recorded as (A) through (J) will be used to determine lower and upper limits for the Amplitude Accuracy and Flatness, and Amplitude Linearity, both of which are on the next page.

Amplitude Accuracy and Flatness

<u>Input Range</u>	<u>Sine Out Ampl.</u>	<u>Lower Limit</u>	<u>Reading</u>	<u>Upper Limit</u>
1 V	1.0000 Vrms	0.99×(A): _____	_____	1.01×(A): _____
300 mV	300.00 mVrms	0.99×(B): _____	_____	1.01×(B): _____
100 mV	100.000 mVrms	0.99×(C): _____	_____	1.01×(C): _____
30 mV	30.000 mVrms	0.99×(D): _____	_____	1.01×(D): _____
10 mV	10.000 mVrms	0.99×(E): _____	_____	1.01×(E): _____

<u>Input Range</u>	<u>Frequency</u>	<u>Lower Limit</u>	<u>Reading</u>	<u>Upper Limit</u>
100 mV	1.0 kHz	0.99×(C): _____	_____	1.01×(C): _____
100 mV	10 kHz	0.99×(G): _____	_____	1.01×(F): _____
100 mV	100 kHz	0.99×(H): _____	_____	1.01×(G): _____
100 mV	500 kHz	0.98×(J): _____	_____	1.02×(H): _____

Amplitude Linearity

<u>Input Range</u>	<u>Sine Out Ampl.</u>	<u>Lower Limit</u>	<u>Reading</u>	<u>Upper Limit</u>
1 V	1.0000 Vrms	0.99×(A): _____	_____	1.01×(A): _____
	100.00 mVrms	0.99×(C): _____	_____	1.01×(C): _____
	10.000 mVrms	0.99×(E): _____	_____	1.01×(E): _____
	1.0000 mVrms	0.99×(F): _____	_____	1.01×(F): _____

Frequency Accuracy

<u>Input Frequency</u>	<u>Lower Limit</u>	<u>Reading</u>	<u>Upper Limit</u>
9.9990 kHz	9.9987 kHz	_____	9.9992 kHz

Phase Accuracy

<u>Frequency</u>	<u>Lower Limit</u>	<u>Reading</u>	<u>Upper Limit</u>
10 Hz	-1.0 deg	_____	+1.0 deg
100 Hz	-1.0 deg	_____	+1.0 deg
1 kHz	-1.0 deg	_____	+1.0 deg
10 kHz	-1.0 deg	_____	+1.0 deg
100 kHz	-1.0 deg	_____	+1.0 deg
500 kHz	-2.5 deg	_____	+2.5 deg

dc Outputs and Inputs

<u>Output</u>	<u>Offset%</u>	<u>Lower Limit</u>	<u>Reading</u>	<u>Upper Limit</u>
CH1	-100.00	9.90 V	_____	10.10 V
	-50.00	4.95 V	_____	5.05 V
	0.00	-0.010 V	_____	0.010 V
	50.00	-5.05 V	_____	-4.95 V
	100.00	-10.10 V	_____	-9.90 V

Test Record sheet 2 of 4

<u>Output</u>	<u>Offset%</u>	<u>Lower Limit</u>	<u>Reading</u>	<u>Upper Limit</u>
CH2	-100.00	9.90 V	_____	10.10 V
	-50.00	4.95 V	_____	5.05 V
	0.00	-0.010 V	_____	0.010 V
	50.00	-5.05 V	_____	-4.95 V
	100.00	-10.10 V	_____	-9.90 V
<u>Output</u>	<u>Voltage</u>	<u>Lower Limit</u>	<u>Reading</u>	<u>Upper Limit</u>
AUX OUT 1	-10.000	-10.10 V	_____	-9.90 V
	-5.000	-5.05 V	_____	-4.95 V
	0.000	-0.010 V	_____	0.010 V
	5.000	4.95 V	_____	5.05 V
	10.000	9.90 V	_____	10.10 V
<u>Output</u>	<u>Voltage</u>	<u>Lower Limit</u>	<u>Reading</u>	<u>Upper Limit</u>
AUX OUT 2	-10.000	-10.10 V	_____	-9.90 V
	-5.000	-5.05 V	_____	-4.95 V
	0.000	-0.010 V	_____	0.010 V
	5.000	4.95 V	_____	5.05 V
	10.000	9.90 V	_____	10.10 V
<u>Output</u>	<u>Voltage</u>	<u>Lower Limit</u>	<u>Reading</u>	<u>Upper Limit</u>
AUX OUT 3	-10.000	-10.10 V	_____	-9.90 V
	-5.000	-5.05 V	_____	-4.95 V
	0.000	-0.010 V	_____	0.010 V
	5.000	4.95 V	_____	5.05 V
	10.000	9.90 V	_____	10.10 V
<u>Output</u>	<u>Voltage</u>	<u>Lower Limit</u>	<u>Reading</u>	<u>Upper Limit</u>
AUX OUT 4	-10.000	-10.10 V	_____	-9.90 V
	-5.000	-5.05 V	_____	-4.95 V
	0.000	-0.010 V	_____	0.010 V
	5.000	4.95 V	_____	5.05 V
	10.000	9.90 V	_____	10.10 V
<u>Input</u>	<u>Voltage</u>	<u>Lower Limit</u>	<u>Reading</u>	<u>Upper Limit</u>
AUX IN 1	-10.000	-10.10 V	_____	-9.90 V
	-5.000	-5.05 V	_____	-4.95 V
	0.000	-0.010 V	_____	0.010 V
	5.000	4.95 V	_____	5.05 V
	10.000	9.90 V	_____	10.10 V

<u>Input</u>	<u>Voltage</u>	<u>Lower Limit</u>	<u>Reading</u>	<u>Upper Limit</u>
AUX IN 2	-10.000	-10.10 V	_____	-9.90 V
	-5.000	-5.05 V	_____	-4.95 V
	0.000	-0.010 V	_____	0.010 V
	5.000	4.95 V	_____	5.05 V
	10.000	9.90 V	_____	10.10 V

<u>Input</u>	<u>Voltage</u>	<u>Lower Limit</u>	<u>Reading</u>	<u>Upper Limit</u>
AUX IN 3	-10.000	-10.10 V	_____	-9.90 V
	-5.000	-5.05 V	_____	-4.95 V
	0.000	-0.010 V	_____	0.010 V
	5.000	4.95 V	_____	5.05 V
	10.000	9.90 V	_____	10.10 V

<u>Input</u>	<u>Voltage</u>	<u>Lower Limit</u>	<u>Reading</u>	<u>Upper Limit</u>
AUX IN 4	-10.000	-10.10 V	_____	-9.90 V
	-5.000	-5.05 V	_____	-4.95 V
	0.000	-0.010 V	_____	0.010 V
	5.000	4.95 V	_____	5.05 V
	10.000	9.90 V	_____	10.10 V

Input Noise

<u>Frequency</u>	<u>Input Range</u>	<u>Sensitivity</u>	<u>Reading</u>	<u>Upper Limit</u>
1 kHz	100 nV	100 nV	_____	5.6 nV (*)

(*) noise limit corresponds to $5 \text{ nV}/\sqrt{\text{Hz}}$, with time constant filter ENBW=1.25 Hz.

Appendix H

Circuit Description

This appendix provides a brief orientation to the signal interface and power supply portions of the SR860 electronics. The FPGA-based motherboard is beyond the scope of this documentation, and servicing or other detailed hardware questions should be referred to the factory.

Signal Input Amplifier

The SR860 signal input module contains both the differential voltage preamplifier and the current input preamplifier. Steering relays set the input configuration, including grounding, ac coupling, and differential or single ended mode. Most relays are of the latching type, requiring only a short pulse to switch states. Relays K102 and K106 are single-side stable, however, and are (separately) energized to select the voltage preamplifier low-gain, or current preamplifier active, respectively.

The voltage input preamplifier uses a cascoded JFET input stage with transistors Q202 and Q101, with feedback provided by U202 and resistors R223, R224, and R225, R226, R230, R231, R293, R294. The current input preamplifier is built with transimpedance gain of 10^6 V/A or 10^8 V/A (R305 or R302). dc offset voltage trim is injected at the fully differential summing junctions for U204, which also provides CMRR trimming for the voltage preamp front-end. Programmable gain blocks around U402 and U404 implement the SR860 Input Range setting, with U406 driving the rear panel Signal Mon after all programmable gain is added. The main analog signal is driven differentially through R428 and R429 to the shielded twisted pair interconnect J401 leading to the motherboard.

Level translators U501A, U502A, U503A, and U504A support overload window comparator circuits, while the differentiators U501B, U502B, and U503B allow for slew rate overload detection. U601 through U603 all perform overload detection, wire-or'ing into buffer U611/U610 for monitoring by the motherboard. Chip selects, clock gating, and relay control is implemented with U701–U709. Analog power for the signal amplifiers is re-regulated from the main power supply ± 16 V to ± 15 V with U710/U711 low noise, low drop-out regulators.

External Reference Input

The reference input module provides signal conditioning for sine and TTL mode external reference inputs for the digital phase-locked loop of the SR860. Input impedance and signal type (sine or TTL) is selected by steering relays K101 and K102, and analog switch U108. The TTL path is dc coupled and discriminated directly with comparator U102, with transition threshold set at +1V. The polarity (rising or falling edge) is selected by U104. The sine path is ac coupled with a 1 s time constant at C117/R132, and buffered by U106. Threshold trimming from U115 is added through R192 before further

amplification at U105 and discrimination at U112. The logic-level reference is then converted into a fast differential transition using current-mode logic from U109, and then level-shifted and slew-rate limited with U102 before being driven differentially through R105, R108 to the shielded twisted pair interconnect J101 leading to the motherboard.

Chip selects, clock gating, and relay control is provided by U201 through U206. dc power is re-regulated from $\pm 16\text{V}$ to $\pm 5\text{V}$ with linear regulators U207 and U208.

Sine Output

The SR860 sine output module provides filtering, attenuation, and dc level generation for the differential sine output. A passive 7th order differential Cauer low pass filter is implemented with components L102–L107, C101–C107, C112–C114. The signal is amplified by U101 (and optionally U102) before being launched through R109–R116 as a 100Ω impedance differential signal. Programmable attenuators are switched in or out using steering relays K102–K109. The dc level control is generated by DAC U105 and amplifier U106, and then driven with 100Ω impedance either directly or through an attenuator divider selected by K110.

The ac signal is then wire-added to the 100Ω impedance dc level to create 50Ω impedance signals at the output BNCs. Chip selects, clock gating, and relay control is implemented with U201–U211. All power rails for the circuit board are re-regulated from the main power supply $\pm 16\text{V}$ to $\pm 15\text{V}$ and $+5\text{V}$ with U212–U214 linear regulators.

Auxiliary I/O

The rear-panel auxiliary I/O circuit supports the 4 AUX OUT and 4 AUX IN analog signals. Outputs are received differentially (referenced to system ground) from the motherboard on header J1, through difference amplifier circuits U1A–U1D. Analog inputs are buffered with amplifiers U1A–U1D, and presenting $1\text{ M}\Omega$ input impedances. The TTL compatible TRIG IN signal is also on this board, but separately interconnected to the motherboard via J11.

Linear Power Supply

The SR860 uses a low noise linear power supply. A multi-tap “universal primary” toroidal transformer can be configured at the power entry module for either 100VAC , 120VAC , 220VAC , or 240VAC . Multiple secondary windings, most of which are center-tapped, provide dedicated power to all sections of the instrument. Multiple independent grounds are left isolated from each other within the power supply to avoid creating ground loops; each circuit, however, is ultimately ground referenced to chassis ground. Bridge rectifiers on the lower power supply board convert $50\text{ Hz} / 60\text{ Hz}$ to dc; some of these components (particularly D6) run quite hot under normal conditions. Unregulated dc power is routed up from the rectifier board to the upper (regulator) board by the 20-pin header J2 located near the rear panel of the SR860.

Linear regulators on the upper power supply board establish the voltage rails for distribution across the instrument. Most regulators are clamped onto the channel heat sink on the center of the board. Please note that the DB-9 connections for the Reference In module (J6) and the Sine Out module (J8) are not interchangeable — these subassemblies have different power requirements and must be cabled correctly. 24 VDC is tapped from

the motherboard connector to header J9 for powering the small cooling fan mounted to the heat sink. Serial SPI control signals are routed from the motherboard to each front-end module (Preamp, Ref In, and Sine Out) through the regulator board; signals come in via J7, and are bussed to pins 4, 5, 8, and 9 of the power/control connectors J2, J6, and J8.

While each set of related voltage rails has a separate ground network, all of these grounds are loosely tied to chassis ground through resistors R31–R36 (10 k Ω each) to avoid any supplies “drifting away” during testing before connection to their loads. Probing of the output voltage levels is best accomplished from test point array TP1–TP20; these test points are protected through 4.7 k Ω resistors to avoid arcing if accidentally shorted.

Partial schematics follow this page.