

CONVERTISSEUR ANALOGIQUE-NUMÉRIQUE
SCHEMA ELECTRIQUE

P70.14

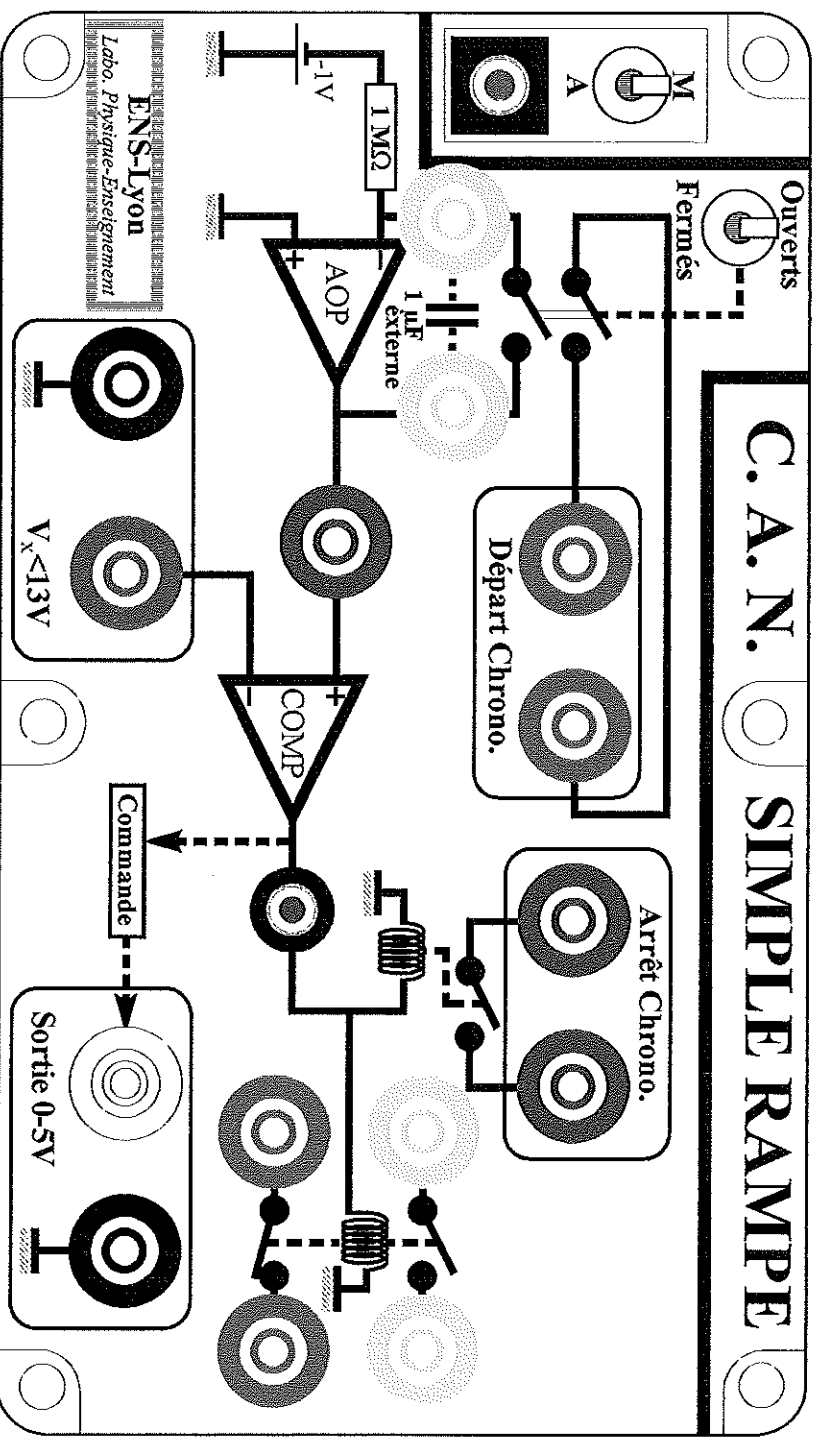

CONVERTISSEUR ANALOGIQUE-NUMÉRIQUE
SCHEMA ÉLECTRIQUE

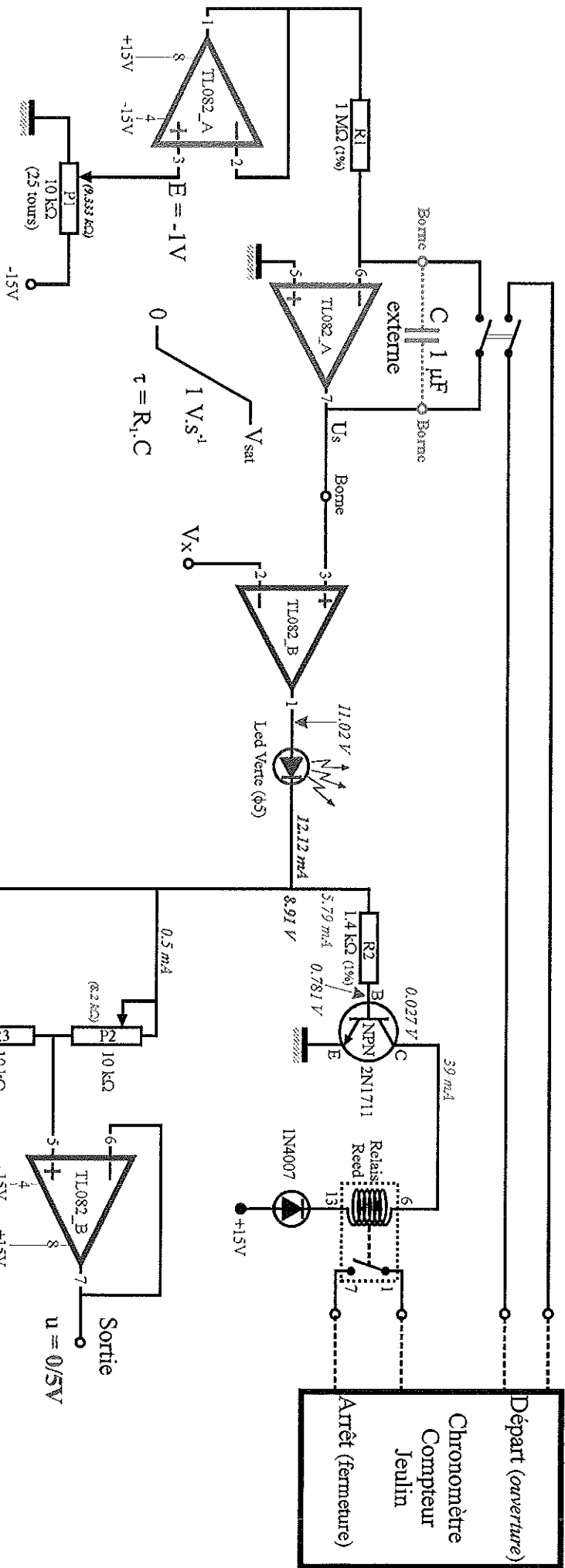

Essais du 14/11/2000 sur plaquette :
En rouge => Valeurs mesurées
En bleu => Valeurs calculées

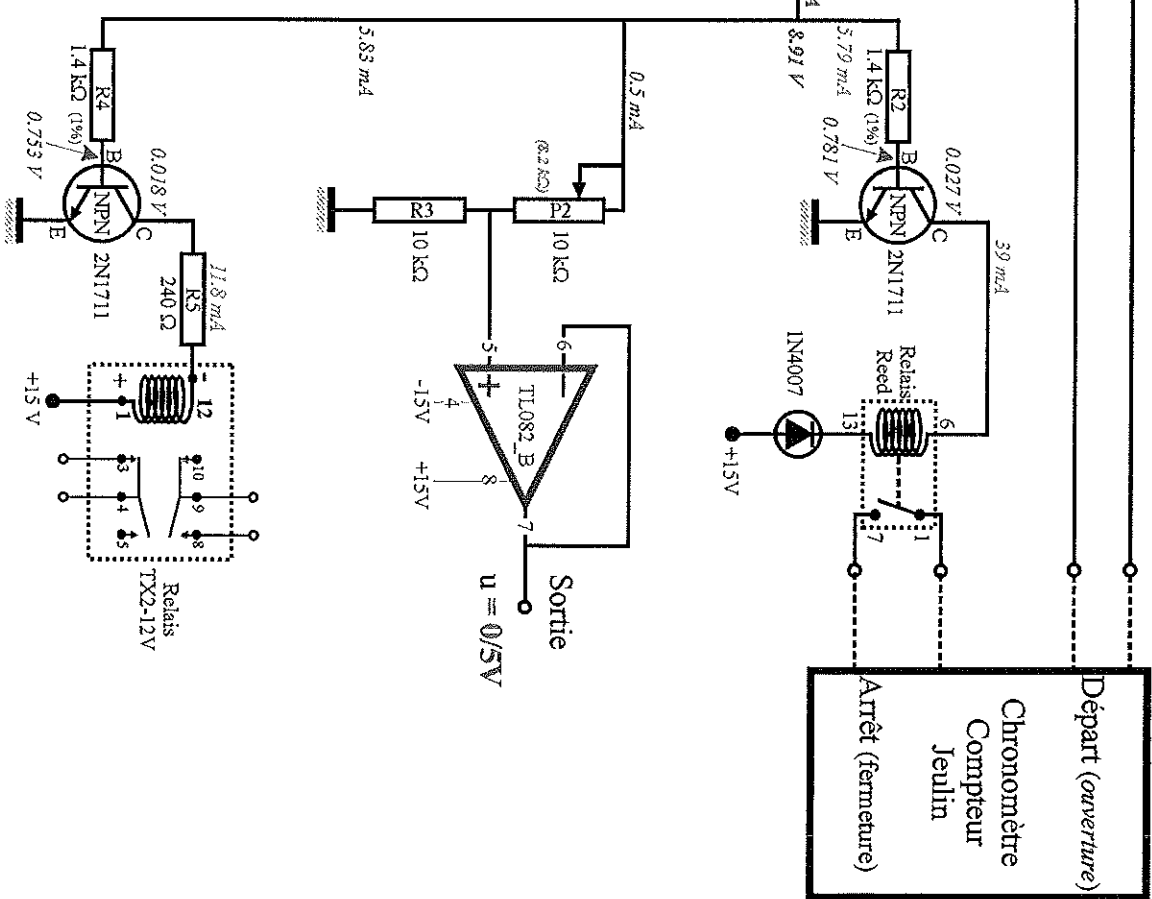
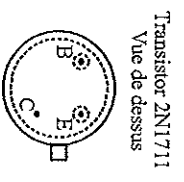
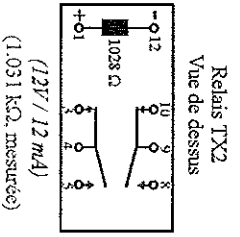
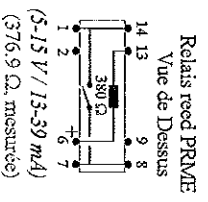

CONVERTISSEUR ANALOGIQUE-NUMÉRIQUE
SCHEMA ÉLECTRIQUE

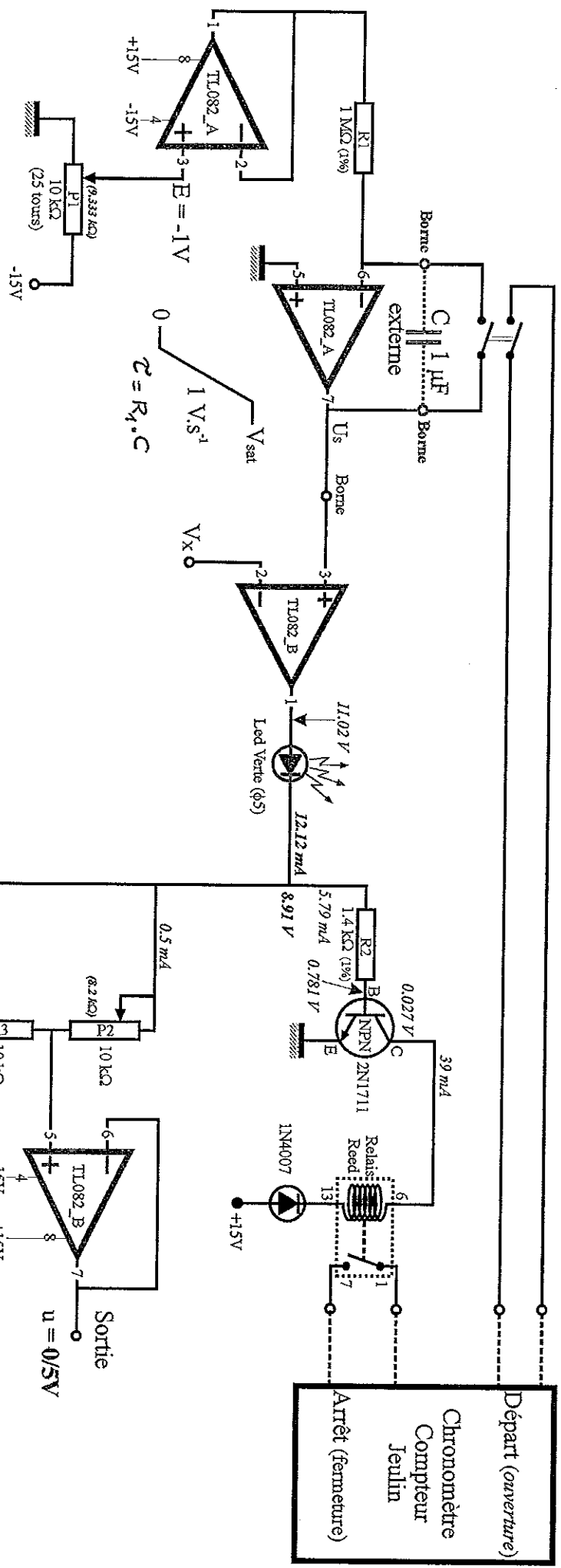

Essais du 14/11/2000 sur plaquette :
En rouge => Valeurs mesurées
En bleu => Valeurs calculées

